

# **FusionServer**

# **X6000 V6 Server**

Technical White Paper

Issue 01

Date 2021-07-16

---

**Copyrights © xFusion Digital Technologies Co., Ltd 2021. All rights reserved.**

No part of this document may be reproduced or transmitted in any form or by any means without prior written consent of xFusion Digital Technologies Co., Ltd.

### **Trademarks and Permissions**

All other trademarks and trade names mentioned in this document are the property of their respective holders.

### **Notice**

The purchased products, services and features are stipulated by the contract made between xFusion Digital Technologies Co., Ltd and the customer. All or part of the products, services and features described in this document may not be within the purchase scope or the usage scope. Unless otherwise specified in the contract, all statements, information, and recommendations in this document are provided "AS IS" without warranties, guarantees or representations of any kind, either express or implied.

The information in this document is subject to change without notice. Every effort has been made in the preparation of this document to ensure accuracy of the contents, but all statements, information, and recommendations in this document do not constitute a warranty of any kind, express or implied.

## **xFusion Digital Technologies Co., Ltd.**

Address: 9th Floor, Building 1, Zensun Boya Square, Longzihu Wisdom Island  
Zhengdong New District 450046  
Zhengzhou, Henan Province  
People's Republic of China

Website: <https://www.xfusion.com>

---

# Contents

---

<b>About This Document</b> .....	<b>v</b>
<b>1 Product Overview</b> .....	<b>7</b>
<b>2 Features</b> .....	<b>8</b>
<b>3 System Architecture</b> .....	<b>10</b>
3.1 Heat Dissipation System.....	10
3.2 Power Supply System.....	11
3.3 Management System.....	15
<b>4 Physical Structure</b> .....	<b>18</b>
<b>5 Hardware Description</b> .....	<b>19</b>
5.1 Front Panel.....	19
5.1.1 Appearance .....	19
5.1.2 Indicators and Buttons .....	20
5.1.3 Ports .....	23
5.2 Rear Panel.....	24
5.3 Storage .....	25
5.3.1 Drive Configurations .....	25
5.3.2 Drive Indicators .....	28
5.4 Fan Modules .....	29
5.5 Middle Modules.....	30
5.6 Server Nodes.....	33
5.7 PSUs .....	34
<b>6 Product Specifications</b> .....	<b>35</b>
6.1 Technical Specifications .....	35
6.2 Environmental Specifications .....	36
6.3 Physical Specifications .....	37
<b>7 Software and Hardware Compatibility</b> .....	<b>39</b>
<b>8 Safety Instructions</b> .....	<b>40</b>
8.1 Security .....	40
8.2 Maintenance and Warranty .....	43

---

<b>9 System Management .....</b>	<b>44</b>
9.1 iBMC .....	44
9.2 Server Management System .....	45
<b>10 Certifications.....</b>	<b>47</b>
<b>A Appendix .....</b>	<b>48</b>
<b>B Glossary.....</b>	<b>53</b>
<b>C Acronyms and Abbreviations.....</b>	<b>56</b>

---

# About This Document

---

## Purpose





This document describes the X6000 V6 servers in terms of appearance, system architecture, and component hardware and software compatibility.

## Intended Audience

This document is intended for pre-sales engineers.

## Symbol Conventions

The symbols that may be found in this document are defined as follows.

Symbol	Description
 <b>DANGER</b>	Indicates a hazard with a high level of risk which, if not avoided, will result in death or serious injury.
 <b>WARNING</b>	Indicates a hazard with a medium level of risk which, if not avoided, could result in death or serious injury.
 <b>CAUTION</b>	Indicates a hazard with a low level of risk which, if not avoided, could result in minor or moderate injury.
 <b>NOTICE</b>	Indicates a potentially hazardous situation which, if not avoided, could result in equipment damage, data loss, performance deterioration, or unanticipated results. NOTICE is used to address practices not related to personal injury.
 <b>NOTE</b>	Supplements the important information in the main text. NOTE is used to address information not related to personal injury, equipment damage, and environment deterioration.

## Change History

Issue	Date	Description
01	2021-07-16	This is the first official release.

---

# 1 Product Overview

---

The FusionServer X6000 V6 server (X6000 V6) is a next-generation 2U high-density server designed for ISPs, Internet, high-performance computing (HPC), cloud computing, and data center applications. Built on an architecture optimized for software-defined storage (SDS), big data, and software-defined infrastructure (SDI), it is ideal for large-scale server deployment.

X6000 V6 servers feature flexible expansion, high density, reliability, energy efficiency, and easy O&M.

- For Internet and data center applications, X6000 V6 servers provide customized solutions that offer rapid deployment, easy maintenance, and low power consumption.
- For HPC, cloud computing, and ISP applications, X6000 V6 servers provide a hardware platform to meet requirements for high reliability and virtualization performance.

**Figure 1-1** X6000 V6 server with 24 x 2.5" drives (example)



# 2 Features

## Ultra-High Density and Small Footprint

X6000 V6 servers provide higher density than conventional rack servers, reducing the footprint in equipment rooms.

- The X6000 V6 server provides computing density twice that of a conventional 1U rack server and four times that of a conventional 2U rack server in the same cabinet space, which greatly improves space utilization in equipment rooms.
- The X6000 V6 server is 2U high and supports a maximum of four server nodes in two configurations:
  - 8 x 2.5" front SAS/SATA drives: Each server node supports 2 x 2.5" SAS/SATA drives. The ventilation rate is optimized to meet heat dissipation requirements of higher specifications.
  - 24 x 2.5" front SAS/SATA/NVMe drives: Each server node supports 6 x 2.5" SAS/SATA/NVMe drives in any mixed configuration ratio.

## Unified Management and Easy Maintenance

X6000 V6 servers use high-density system architecture, and support maintenance in the cold air area.

- Server node management network port supports aggregated management, so that iBMCs of each server node can work collaboratively to manage fans, PSUs, and other system assets, combining the benefits of blade and rack servers. You can have out-of-band management for the entire system by connecting to the management network port on any server node.

### NOTE

If only one management network cable is connected to a node, restarting the node will interrupt the management network of the server. The management network will be restored after the iBMC of the node is restarted. If two or more management network cables are connected to any two nodes, this problem can be avoided.

- Server nodes are installed in the rear area and cables are connected to the rear panel, facilitating maintenance.
- X6000 V6 servers adopt the modular design. Drives, fan modules, server nodes, PSUs, and OCP 3.0 network adapters are hot-swappable, greatly improving O&M efficiency.



## Shared Architecture and High Energy Efficiency

All server nodes share the system power supply and heat dissipation, improving the power conversion efficiency and reducing energy consumption of heat dissipation. This maximizes the energy efficiency.

- Server nodes share four PSUs in 1+1 or 2+2 redundancy mode based on power consumption, improving power supply capability.
- Server nodes share four counter-rotating fan modules with high wind pressure, which simplifies deployment, improves fan utilization, and enhances the heat dissipation capability of the entire system.
- X6000 V6 servers use Dynamic Energy Management Technology (DEMT) to minimize system energy consumption.
- X6000 V6 servers do not have drive backplanes or system backplanes. This allows ideal system ventilation for processors with the highest specifications.

## Redundancy and Reliability

X6000 V6 servers use reliable system architecture that ensures stable and long-term service running.

- Supports four PSUs in 1+1 or 2+2 redundancy based on different power consumption configurations.  
Supports four fan modules in N+1 redundancy mode to improve system reliability.
- Provides RAID controller cards and supercapacitors for power-off protection, ensuring zero service interruption and data loss.
- Carrier-class components and manufacturing processes provide higher stability and longer lifecycle.

# 3 System Architecture

- 3.1 Heat Dissipation System
- 3.2 Power Supply System
- 3.3 Management System

## 3.1 Heat Dissipation System

- Air is drawn from the front panel and exhausts from the rear panel. Cool air enters the front panel and passes through the drives, fan modules, middle modules, four server nodes, processors, and DIMMs, and then exits from the rear panel. Air vents are provided on the top, bottom, and side of the server to help heat dissipation.

**Figure 3-1** Top view of the X6000 V6 air flow

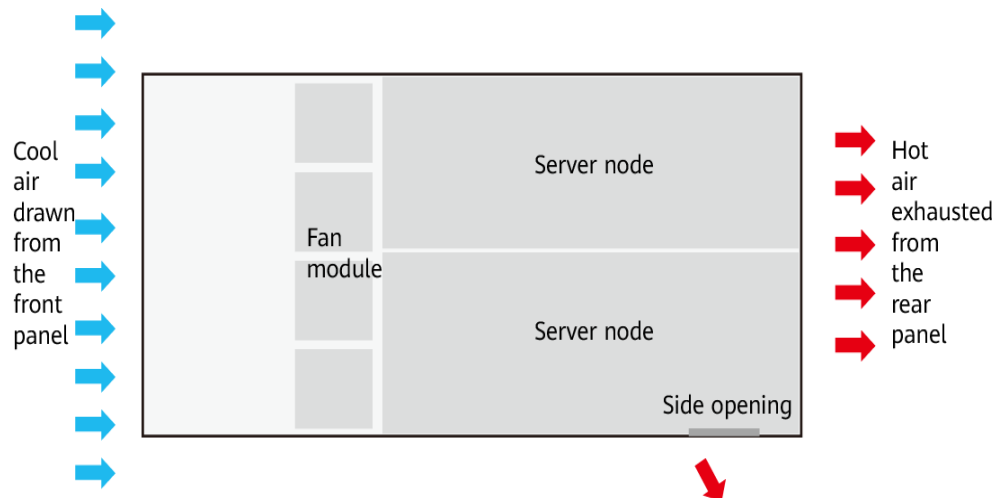

**Figure 3-2** Side view of the X6000 V6 air flow

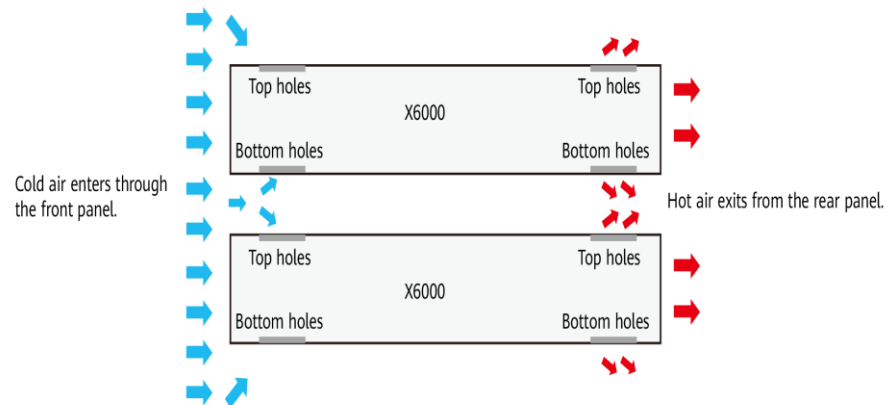

**NOTICE**

- Ensure that heat is dissipated from the cabinet in time. Heat accumulation and air reflow affect the heat dissipation of the server.
  - To prevent device damage due to insufficient heat dissipation, do not block air vents.
- 
- The server uses four 8080/8080+ counter-rotating fans with high wind pressure to improve the heat dissipation capability of X6000 V6 servers, achieving the maximum configuration, power consumption density, and temperature specifications in the industry.
  - System energy efficiency optimization: DTS 2.0 intelligently adjusts the fan speed to save energy and achieve optimal energy efficiency.
  - With speed adjustment, shock absorption, and noise isolation design, X6000 V6 servers can minimize noise while dissipating heat efficiently.
  - Optimized heat dissipation design:
    - Counter-rotating fans with high wind pressure: 20% higher capability of 8080+ fans compared with the last-generation 8080 fans.
    - The refined ventilation channel design concentrates the heat dissipation on heat-sensitive components, improving the heat dissipation efficiency.
    - Reasonable layout of temperature sensors, full coverage of hot spots, and precise speed adjustment.
    - The cellular board increases the porosity by 10% compared with the square hole design.
    - The fan modules use the proportional–integral–derivative (PID) algorithm to ensure that the system can run stably at 35°C (95°F) for a long time.

## 3.2 Power Supply System

The X6000 V6 server supports two or four hot-swappable PSUs. Based on the relationship between the rated power of the PSUs and that of the server, there are different redundancy modes to ensure that the system performance is not affected and the system does not break down when a power supply or PSU fault occurs. For details, see Table 3-1.

**Table 3-1** PSU and power supply redundancy

Number of PSUs	PSU Rated Power and Server Rated Power	PSU Redundancy	Power Supply Redundancy
2	Server < Single PSU	1+1	1+1
	Single PSU ≤ Server	MSPP is used to enable redundancy.	
4	Server < 2 PSUs	2+2	1+1
	2 PSUs ≤ Server < 3 PSUs	3+1	MSPP is used to enable redundancy.
	3 PSUs ≤ Server	MSPP is used to enable redundancy.	
<ul style="list-style-type: none"> <li>• MSPP is a multi-node power capping function. If the power supply or a PSU fails, MSPP is triggered (see Table 3-2) to lower the power consumption upper limit of the server, ensuring that the system's power does not exceed the total rated power of the remaining normal PSUs. In this case, the upper limit of the system performance is affected.</li> <li>• "+N" redundancy of PSUs indicates that the server performance is not affected when <i>N</i> PSUs fail.</li> <li>• "+N" redundancy of power supply indicates that the server performance is not affected when <i>N</i> power supplies fail.</li> <li>• In typical configuration, the power of an X6000 V6 PSU is 2000 W. The total rated server power is rarely greater than the total rated power of three PSUs.</li> </ul>			

## Power Capping Mode

The X6000 V6 server supports the following power capping modes:

- **MSPP**

The system automatically enables or disables MSPP based on the relationship between the rated power of the server and that of PSUs as described in Table 3-2.

If MSPP is enabled, when a system power supply or PSU fault occurs, MSPP is triggered (see Table 3-2). After MSPP is triggered, the system sets the power consumption upper limit for the server node based on the total rated power of the remaining normal PSUs to ensure that the power of the entire system does not exceed the total rated power. In this case, the upper limit of the system performance is affected.

 **NOTE**

- After MSPP is enabled, the server performance will deteriorate. The performance deteriorates more as the gap between the server rated power and the capped power becomes larger.
- MSPP cannot eliminate server breakdowns in some extreme scenarios:
- Improper maintenance operations, such as removing a PSU without removing the cable first, will cause system power failure because MSPP cannot be triggered before other PSUs are overloaded. To prevent this problem, remove the cable before removing a PSU.
- If a PSU short circuit fault occurs, the power supply cannot remain for 10 ms for MSPP to be triggered and a system breakdown will occur. According to historical statistics, the failure rate of PSU short circuits is less than 0.0002%.
- User-defined power capping mode

This mode enables you to set a power capping value for the server or a server node to adjust the power distribution of the cabinet or equipment room. User configuration modes are classified into the following types:

- User-defined server power capping:  
 You can enable the power capping function for a server using the iBMC CLI and set the power capping value as required. After the configuration is successful, the power of the server does not exceed the configured power.
- User-defined server node power capping:  
 You can enable the power capping function for a server node on the iBMC WebUI and set the power capping value as required. After the configuration is successful, the power of the server node does not exceed the configured power.

 **NOTE**

- MSPP and user-defined power capping cannot be enabled together.
- Before using the MSPP or user-defined power capping mode, enable EIST on the BIOS. For details, see *FusionServer X6000 Server iBMC User Guide*.
- For details about how to configure the power capping mode, see *FusionServer X6000 Server iBMC User Guide*.

When different number of PSUs are configured, the system automatically enables the MSPP or user-defined power capping mode based on the rated power of the server and that of the PSUs. For details, see Table 3-2.

**Table 3-2** Status of the MSPP or user-defined power capping mode

Number of PSUs	PSU Rated Power and Server Rated Power	Power Capping Mode Status (Set by the System)
2	Server < Single PSU	<ul style="list-style-type: none"> <li>• MSPP disabled</li> <li>• User-defined power capping disabled</li> </ul>
	Single PSU ≤ Server	<ul style="list-style-type: none"> <li>• MSPP enabled (triggered by a single PSU failure)</li> <li>• User-defined power capping disabled</li> </ul>
4	Server < 2 PSUs	<ul style="list-style-type: none"> <li>• MSPP disabled</li> <li>• User-defined power capping disabled</li> </ul>
	2 PSUs ≤ Server < 3 PSUs	<ul style="list-style-type: none"> <li>• MSPP enabled (triggered by failure of two PSUs)</li> <li>• User-defined power capping disabled</li> </ul>
	3 PSUs ≤ Server	<ul style="list-style-type: none"> <li>• MSPP enabled (triggered by a single PSU failure)</li> <li>• User-defined power capping disabled</li> </ul>

 **NOTE**

After modifying the configuration or adding optional components, you need to recalculate the total power of the server to check whether the current PSUs meet the requirements of the new system.

## PSU Working Mode

The X6000 V6 server supports the following PSU working modes:

- Active/Standby mode:
  - 1+1 active/standby mode: This mode is supported when the X6000 V6 server is configured with two PSUs and the real-time power of the server is less than the rated power of a single PSU. In this mode, the active PSU bears the system load, and the standby PSU works in the hot standby state.
  - 2+2 active/standby mode: This mode is supported when the X6000 V6 server is configured with four PSUs and the real-time power of the server is less than the total rated power of two PSUs. In this mode, two active PSUs bear the system load, and the two standby PSUs work in hot standby state.

### NOTE

After a PSU enters the hot standby state, the output current decreases and the power indicator is steady green, which is the same as the normal state. You can query the PSU status by running the **ipmcget -d psuinfo** command on the iBMC CLI. For details, see the *FusionServer X6000 Server iBMC User Guide*.

In active/standby mode:

- If the real-time power of the server exceeds the total rated power of active PSUs, the standby PSUs are woken up and the system enters the load balancing mode.
- If any PSU is removed or the input is lost, the standby PSU is woken up and enters the normal output state to ensure that the entire system is not powered off.
- Load balancing mode: In this mode, each PSU evenly bears the system load, and their output power is similar.

PSUs work in load balancing mode by default. To set the PSUs to work in active/standby mode, log in to the iBMC WebUI, choose **System > Power > Power Supply Info > Power Supply Settings** to set the Work Mode to **Active/Standby**. Table 3-3 describes PSU working modes based on the relationship between the real-time power of the server and that of PSUs when different number of PSUs are configured.

**Table 3-3** Active/Standby and load balancing modes

Number of PSUs	MSP P Status <small>Note</small>	Total PSU Rated Power and Real-Time Server Power	PSU Working Mode
2	Triggered	-	Load balancing mode
	Not triggered	Server < Single PSU	By default, the load balancing mode is used. You can change it to 1+1 active/standby mode. When the real-time power of the server exceeds the rated power of a single PSU, the system automatically switches to the load balancing mode.
		Single PSU ≤ Server	Load balancing mode
4	Triggered	-	Load balancing mode
	Not	Server < 2 PSUs	By default, the load balancing mode is used.

Number of PSUs	MSP P Status <small>Note</small>	Total PSU Rated Power and Real-Time Server Power	PSU Working Mode
	triggered		You can change it to 2+2 active/standby mode. When the real-time power of the server exceeds the total rated power of two PSUs, the system automatically switches to the load balancing mode.
		2 PSUs ≤ Server < 3 PSUs	Load balancing mode
		3 PSUs ≤ Server	Load balancing mode
Note: For details about the MSPP triggering conditions, see Table 3-2.			

### 3.3 Management System

The X6000 V6 server management system uses the iBMC collaborative management architecture. Customers can manage server nodes and the chassis through the management network port of any server node.

- Each server node iBMC manages the server node through the IPMI, KVM, or virtual CD-ROM drive.
- The iBMCs of server nodes collaboratively manage the chassis, including the fan modules, power supplies, and chassis assets.

**Figure 3-3** X6000 V6 monitoring and management design

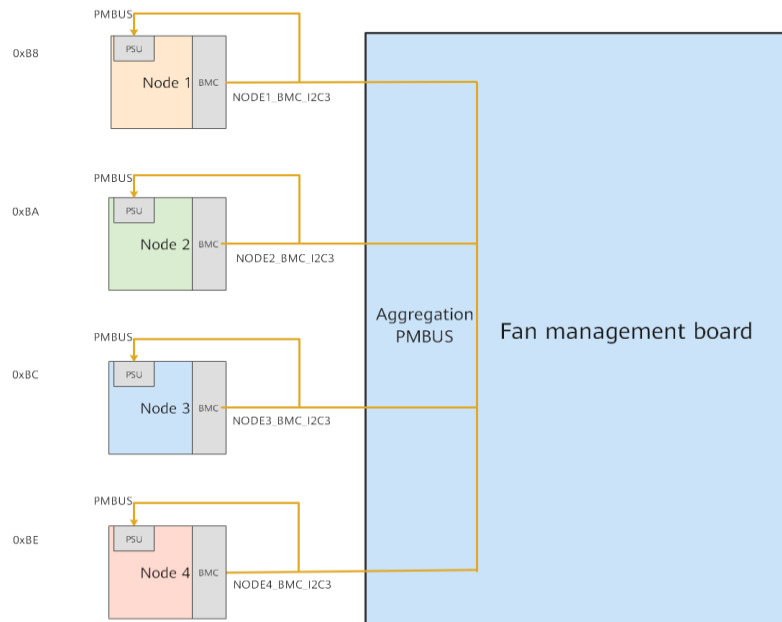

## Server Nodes

The iBMC of each X6000 V6 server node provides an independent IP address for external access. You can access the iBMC of any server node to manage an X6000 V6 server.

You can access the iBMC of a server node in the following ways:

- Access the iBMC through the management network port of a server node. (You can access iBMCs of the four server nodes through the management network port of any server node.)
- Access the iBMC of a server node through the direct connection management port.
- Access the iBMC in NC-SI mode through the service network port of the NIC that supports NC-SI.

The out-of-band management network cables are connected to a server node (the default configuration on the BIOS menu). For details, see Figure 3-4.



**Figure 3-4** Point-to-point cabling

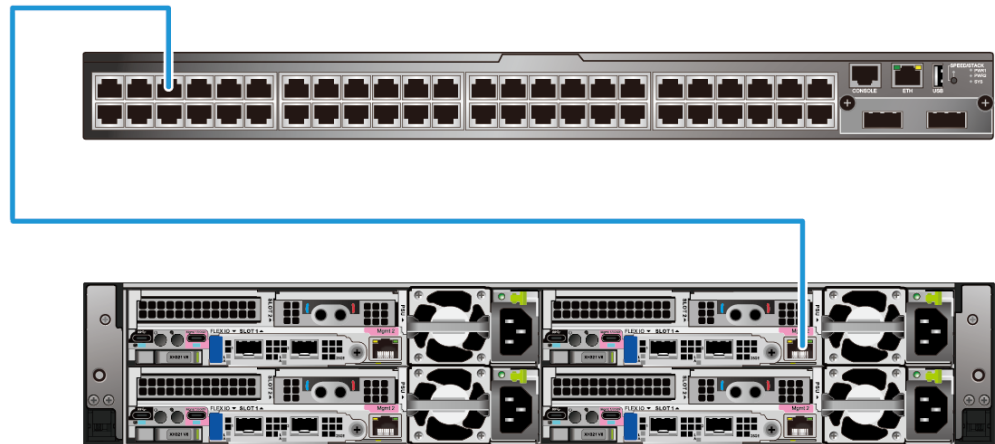

**NOTE**

In NC-SI mode, the management network cable can be used as a service network cable and connected to a service network port.

## Fan modules

The server node iBMCs and fan management board work together to monitor and manage fan modules.

- The server node iBMC determines a proper speed based on speed adjustment algorithms and delivers the speed to the fan management board in the middle module to control the fan speed. The fan management board detects the operating status of the fan modules through the rotation speed feedback signals, and reports to server node iBMCs for the fan module health management.
- The fan management board of the middle module provides four independent pulse-width modulation (PWM) control signals for controlling the fan speed and eight TACH signals for detecting the fan speed.

## PSUs

The server node iBMCs and fan management board work together to monitor and manage PSUs.

- Each server node provides an I2C bus to manage all PSUs. The iBMC of each server node supports input power queries, installation status detection, and PSU alarm reporting.
- The iBMC of each server node and the CPLD of the fan management board in the middle module provide the GPIO to detect the presence and PWROK of PSUs.

# 4 Physical Structure

**Figure 4-1** Physical structure of an X6000 V6 server with 8 x 2.5" drives (example)

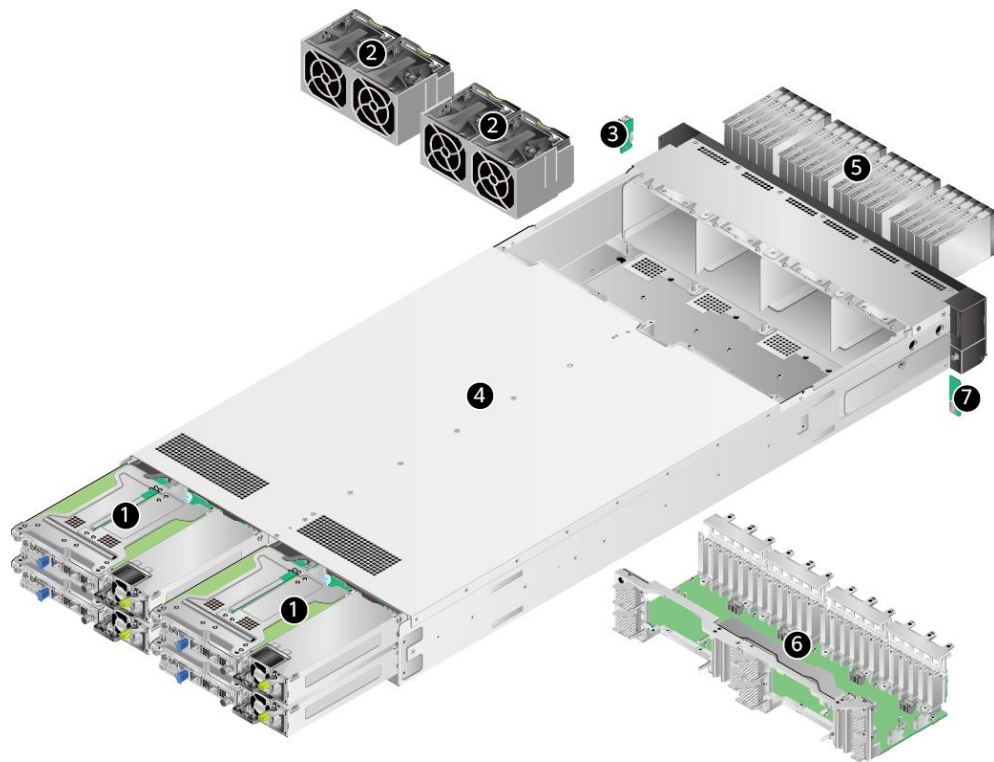

1	Server nodes	2	Fan modules
3	Right mounting ear plate	4	Node case
5	Drives	6	Middle modules
7	Left mounting ear plate	-	-

# 5 Hardware Description

- 5.1 Front Panel
- 5.2 Rear Panel
- 5.3 Storage
- 5.4 Fan Modules
- 5.5 Middle Modules
- 5.6 Server Nodes
- 5.7 PSUs

## 5.1 Front Panel

### 5.1.1 Appearance

- 8 x 2.5" drive configuration

**Figure 5-1** Front panel of a server with 8 x 2.5" drives

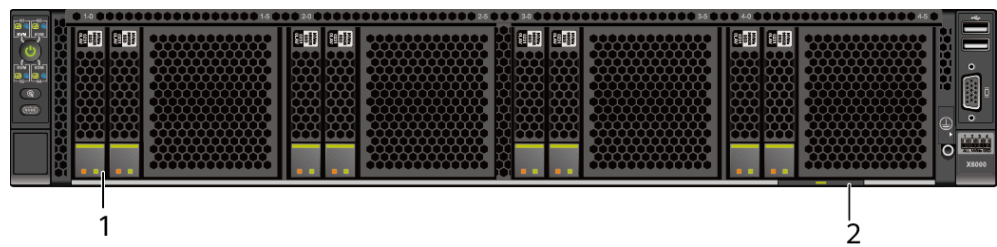

1	Drives	2	Slide-out label plate (with an SN label)
---	--------	---	--

- 24 x 2.5" drive configuration

**Figure 5-2** Front panel of a server with 24 x 2.5" drives

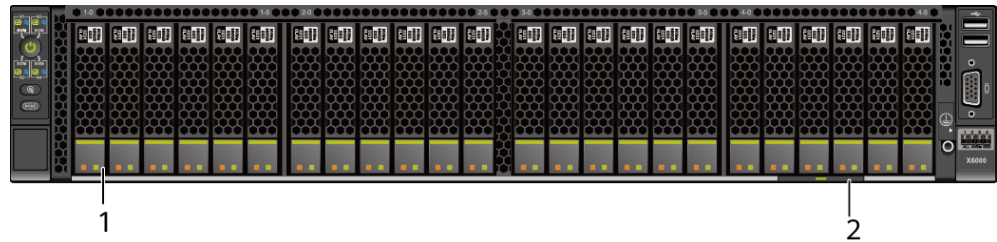

1	Drives	2	Slide-out label plate (with an SN label)
---	--------	---	--

## 5.1.2 Indicators and Buttons

### Indicator and Button Positions

- 8 x 2.5" drive configuration

**Figure 5-3** Indicators and buttons on the front panel

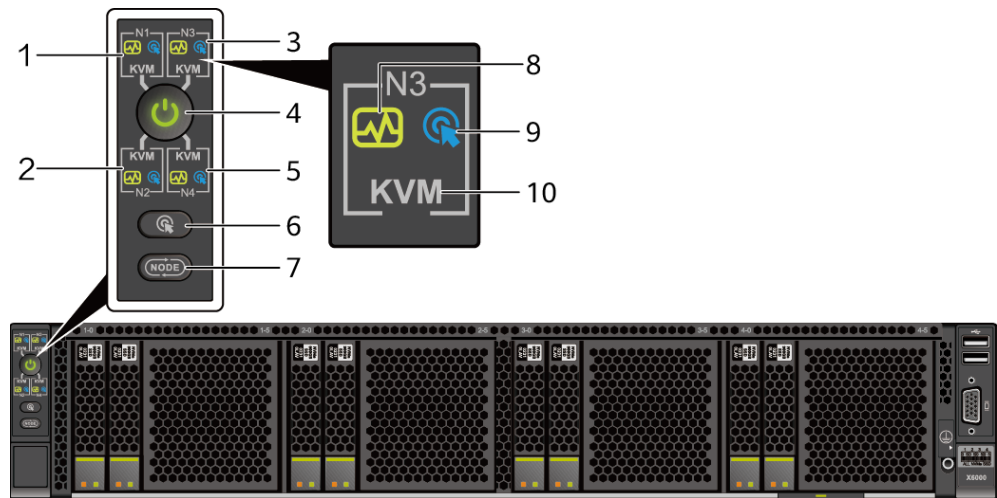

1	Indicators of server node 1	2	Indicators of server node 2
3	Indicators of server node 3	4	Power button/indicators
5	Indicators of server node 4	6	Unit Identification Light (UID) button
7	Server node switchover button	8	Server node health indicator
9	Server node UID indicators	10	Server node indicators

- 24 x 2.5" drive configuration

**Figure 5-4** Indicators and buttons on the front panel

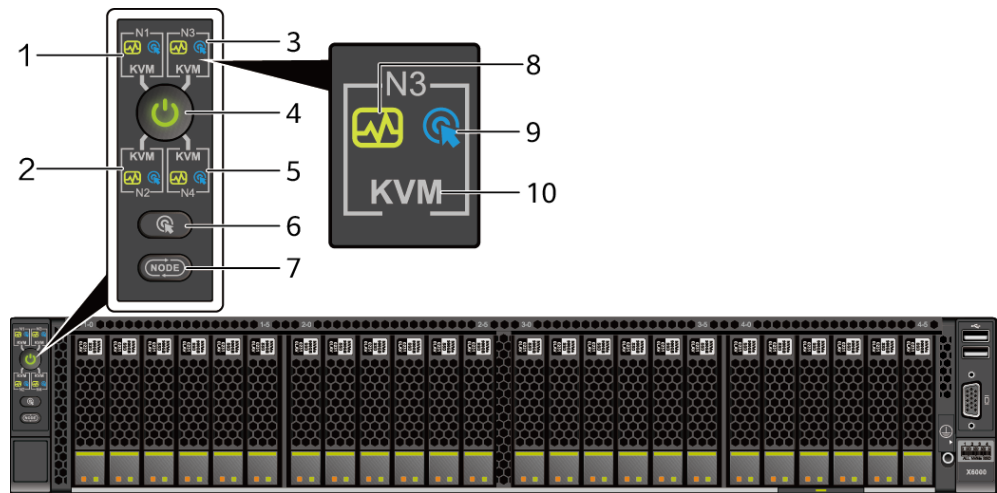





1	Indicators of server node 1	2	Indicators of server node 2
3	Indicators of server node 3	4	Power button/indicators
5	Indicators of server node 4	6	Unit Identification Light (UID) button
7	Server node switchover button	8	Server node health indicator
9	Server node UID indicators	10	Server node indicators

## Indicator and Button Description

**Table 5-1** Description of indicators and buttons on the front panel

Silks creen	Name	Description
	Power button/Indicator	<p>Indicates the power status of the selected server node. For details, see the server node indicator descriptions.</p> <ul style="list-style-type: none"> <li>• Off: The device is not powered on.</li> <li>• Steady green: The device is powered on.</li> <li>• Blinking yellow: The iBMC is starting. The power button is locked and cannot be pressed. The iBMC is started in about 1 minute, and then the power indicator is steady green.</li> <li>• Steady yellow: The device is standby.</li> </ul> <p>Power button description:</p> <ul style="list-style-type: none"> <li>• When the device is powered on, you can press this button to gracefully shut down the OS.</li> </ul>

Silkscreen	Name	Description
		<p><b>NOTE</b></p> <p>For different OSs, you may need to shut down the OS as prompted.</p> <ul style="list-style-type: none"> <li>When the device is powered on, you can hold down this button for 6 seconds to forcibly power off the device.</li> <li>When the power indicator is steady yellow, you can press this button to power on the device.</li> </ul>
	UID button	<p>The UID button is used to locate the server node to be operated.</p> <p>UID button:</p> <ul style="list-style-type: none"> <li>You can press the UID button or use the iBMC remote control to turn on or off the UID indicator of a server node.</li> <li>You can press the UID button to turn on or off the UID indicator of a server node.</li> <li>You can press and hold down the UID button for 4 to 6 seconds to reset the iBMC of the server node.</li> </ul>
	Server node UID indicator	<p>The UID indicator is used to locate the server node to be operated.</p> <ul style="list-style-type: none"> <li>Off: The device is not being located.</li> <li>Blinking or steady blue: The device is being located.</li> </ul>
	Server node switchover button	<p>Press the server node switchover button to switch to the selected server node. When a server node is selected, its indicator is steady white.</p> <p><b>NOTE</b></p> <p>If the server is not fully configured with server nodes, the system automatically skips vacant server node positions after you press the node switchover button, and switches among detected server nodes. If there are only three server nodes (server node 1, server node 2, and server node 4), server node 3 is skipped automatically when a switchover is initiated.</p>
	Server node health indicator	<p>Indicates the health status of each server node.</p> <ul style="list-style-type: none"> <li>Off: There is no power supply, or the server node is faulty.</li> <li>Blinking red at 1 Hz: A major alarm has been generated on the system.</li> <li>Blinking red at 5 Hz: A critical alarm has been generated on the system.</li> <li>Steady green: The device is operating properly.</li> </ul>
	Server node indicator	<p>Indicates whether a server node is selected.</p> <ul style="list-style-type: none"> <li>Off: The server node is not selected.</li> <li>Steady white: The server node is selected.</li> </ul> <p><b>NOTE</b></p> <ul style="list-style-type: none"> <li>Press the server node switchover button to switch to the selected server node.</li> <li>When a server node is selected, connection to the server node is switched to the power button/indicator and UID button on the left</li> </ul>

Silks creen	Name	Description
		mounting ear as well as the VGA and USB ports on the right mounting ear.

## 5.1.3 Ports

### Port Positions

- 8 x 2.5" drive configuration

**Figure 5-5** Ports on the front panel

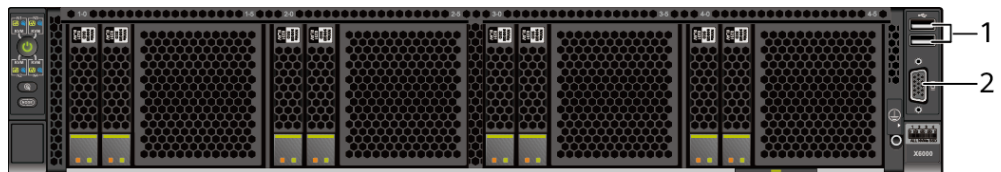

1	USB 2.0 port	2	VGA Ports
---	--------------	---	-----------

- 24 x 2.5" drive configuration

**Figure 5-6** Ports on the front panel



1	USB 2.0 port	2	VGA Ports
---	--------------	---	-----------

### Port Description

**Table 5-2** Description of ports on the front panel

Name	Type	Quantity	Description
USB ports	USB 2.0	2	Used to connect to a USB 2.0 device. <b>NOTICE</b> <ul style="list-style-type: none"> <li>A connected external USB device supports a maximum current of</li> </ul>

Name	Type	Quantity	Description
			1.2 A. <ul style="list-style-type: none"> <li>Before connecting an external USB device, ensure that the USB device functions properly; otherwise, it may adversely impact the server.</li> </ul>
VGA ports	DB15	1	Used to connect a display terminal, such as a monitor or KVM.

## 5.2 Rear Panel

- Air-cooled server node configuration

**Figure 5-7** Rear panel of a server with four XH321 V6 server nodes

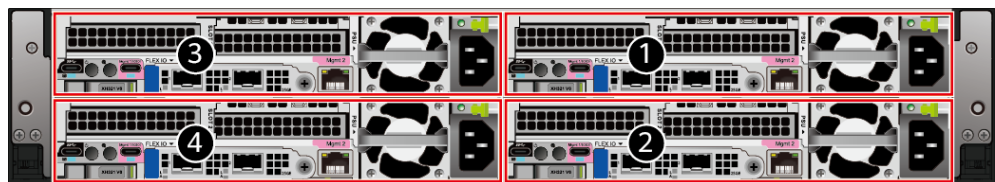

1	Air-cooled server node 1	2	Air-cooled server node 2
3	Air-cooled server node 3	4	Air-cooled server node 4

- Liquid-cooled server node configuration

**Figure 5-8** Rear panel of a server with four XH321C V6 server nodes

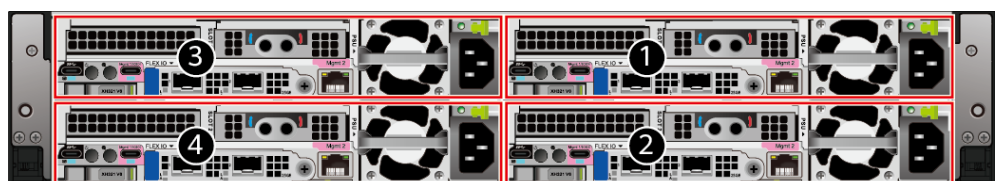

1	Liquid-cooled server node 1	2	Liquid-cooled server node 2
3	Liquid-cooled server node 3	4	Liquid-cooled server node 4



## 5.3 Storage

### 5.3.1 Drive Configurations

#### Drive Configuration

**Table 5-3** Drive Configuration

Configuration	Front Drive	Drive Management Mode
8 x 2.5" drive configuration 1	<ul style="list-style-type: none"> <li>• Front drive: 8 x 2.5"                             <ul style="list-style-type: none"> <li>– Slots 1-0 to 4-1 support only SATA drives.</li> <li>– Each node supports a maximum of two drives.</li> </ul> </li> </ul>	<ul style="list-style-type: none"> <li>• PCH pass-through</li> </ul>
8 x 2.5" drive configuration 2	<ul style="list-style-type: none"> <li>• Front drive: 8 x 2.5"                             <ul style="list-style-type: none"> <li>– Slots 1-0 to 4-1 support SAS/SATA drives.</li> <li>– Each node supports a maximum of two drives.</li> </ul> </li> </ul>	<ul style="list-style-type: none"> <li>• Screw-in RAID controller card</li> </ul>
24 x 2.5" drive configuration 1	<ul style="list-style-type: none"> <li>• Front drive: 24 x 2.5"                             <ul style="list-style-type: none"> <li>– Slots 1-0 to 4-5 support SATA/NVMe drives.</li> <li>– Each node supports a maximum of six drives.</li> </ul> </li> </ul>	<ul style="list-style-type: none"> <li>• SATA drive: PCH</li> <li>• NVMe drive: CPU</li> </ul>
24 x 2.5" drive configuration 2	<ul style="list-style-type: none"> <li>• Front drive: 24 x 2.5"                             <ul style="list-style-type: none"> <li>– Slots 1-0 to 4-5 support SAS/SATA/NVMe drives.</li> <li>– Each node supports a maximum of six drives.</li> </ul> </li> </ul>	<ul style="list-style-type: none"> <li>• SAS/SATA drive: screw-in RAID controller card</li> <li>• NVMe drive: CPU</li> </ul>
For details about the components that can be purchased, contact technical support.		

#### Slot numbers

- Table 5-3 shows drive slot numbers of 8 x 2.5" drive configuration 1 and 8 x 2.5" drive configuration 2

**Figure 5-9** Slot numbers

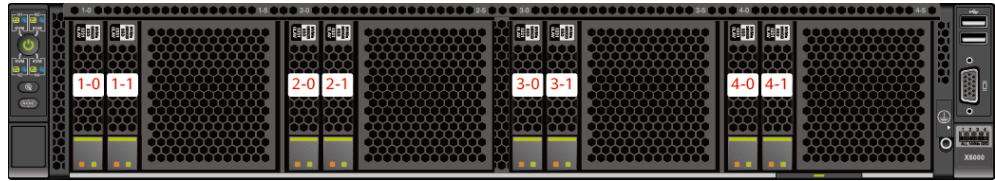

Each server node manages two drives. Drives from left to right are managed by server node 1, server node 2, server node 3, and server node 4 in sequence.

**Table 5-4** Slot numbers

Server Node	Drive No.	Drive Number Displayed on the iBMC WebUI
Server node 1	1-0	0
	1-1	1
Server node 2	2-0	0
	2-1	1
Server node 3	3-0	0
	3-1	1
Server node 4	4-0	0
	4-1	1

- Table 5-3 shows drive slot numbers of 24 x 2.5" drive configuration 1 and 24 x 2.5" drive configuration 2

**Figure 5-10** Slot numbers

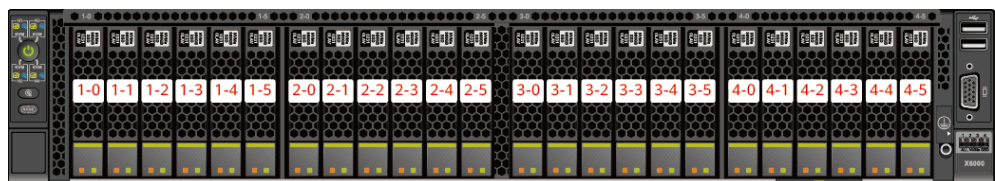

Each server node manages six drives. Drives from left to right are managed by server node 1, server node 2, server node 3, and server node 4 in sequence.

**Table 5-5** Slot numbers

Server Node	Drive No.	Drive Number Displayed on the iBMC WebUI
-------------	-----------	--

Server Node	Drive No.	Drive Number Displayed on the iBMC WebUI
Server node 1	1-0	0
	1-1	1
	1-2	2
	1-3	3
	1-4	4
	1-5	5
Server node 2	2-0	0
	2-1	1
	2-2	2
	2-3	3
	2-4	4
	2-5	5
Server node 3	3-0	0
	3-1	1
	3-2	2
	3-3	3
	3-4	4
	3-5	5
Server node 4	4-0	0
	4-1	1
	4-2	2
	4-3	3
	4-4	4
	4-5	5

## 5.3.2 Drive Indicators

### SAS/SATA Drive Indicators

Figure 5-11 SAS/SATA drive indicators

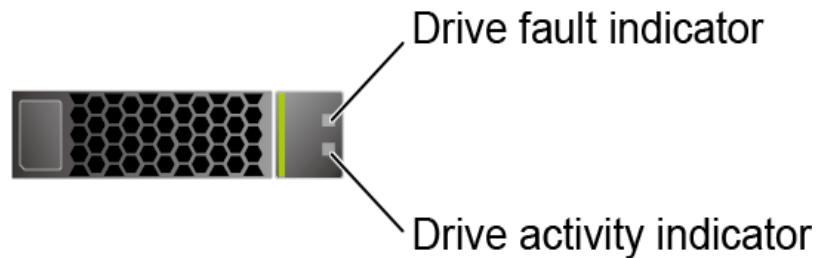
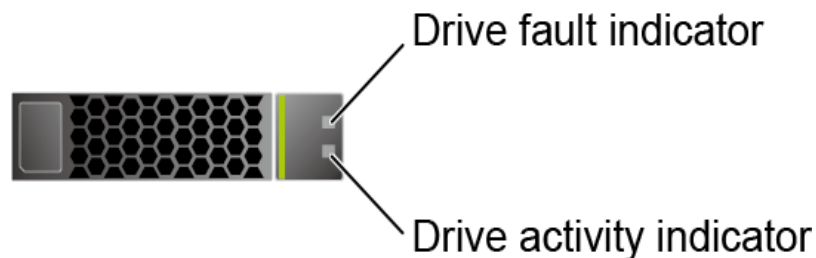

Table 5-6 SAS/SATA drive indicators

Activity Indicator (Green)	Fault Indicator (Yellow)	Description
Steady on	Off	The drive is detected.
Blinking at 4 Hz	Off	Data is being read or written properly, or data on the primary drive is being rebuilt.
Steady on	Blinking at 1 Hz	The drive is being located.
Blinking at 1 Hz	Blinking at 1 Hz	Data on the secondary drive is being rebuilt.
Off	Steady on	A drive in a RAID array is removed.
Steady on	Steady on	The drive is faulty.

### NVMe Drive Indicators

Figure 5-12 NVMe drive indicators



- If the VMD function is enabled and the latest VMD driver is installed, the NVMe drives support surprise hot swap.

**Table 5-7** NVMe drive indicators (VMD enabled)

Activity Indicator (Green)	Fault Indicator (Yellow)	Description
Off	Off	The NVMe drive is not detected.
Steady on	Off	The NVMe drive is detected and operating properly.
Blinking at 2 Hz	Off	Data is being read from or written to the NVMe drive.
Off	Blinking at 2 Hz	The NVMe drive is being located.
Off	Blinking at 8 Hz	The data on the secondary NVMe drive is being rebuilt.
Steady on/Off	Steady on	The NVMe drive is faulty.

- If the VMD function is disabled, NVMe drives support only orderly hot swap.

**Table 5-8** NVMe drive indicators (VMD disabled)

Activity Indicator (Green)	Fault Indicator (Yellow)	Description
Off	Off	The NVMe drive is not detected.
Steady on	Off	The NVMe drive is detected and operating properly.
Blinking at 2 Hz	Off	Data is being read from or written to the NVMe drive.
Off	Blinking at 2 Hz	The NVMe drive is being located or hot-swapped.
Off	Blinking at 0.5 Hz	The NVMe drive has completed the hot swap process and is removable.
Steady on/Off	Steady on	The NVMe drive is faulty.

## 5.4 Fan Modules

- Supports four 8080/8080+ counter-rotating fan modules with high wind pressure.
- The fan modules are hot-swappable.
- N+1 redundancy is supported. That is, the server can work properly when a single fan rotor fails.
- The fan speed can be adjusted.
- Fan modules of the same part number (P/N code) must be used in a server.

**Figure 5-13** Positions of fan modules

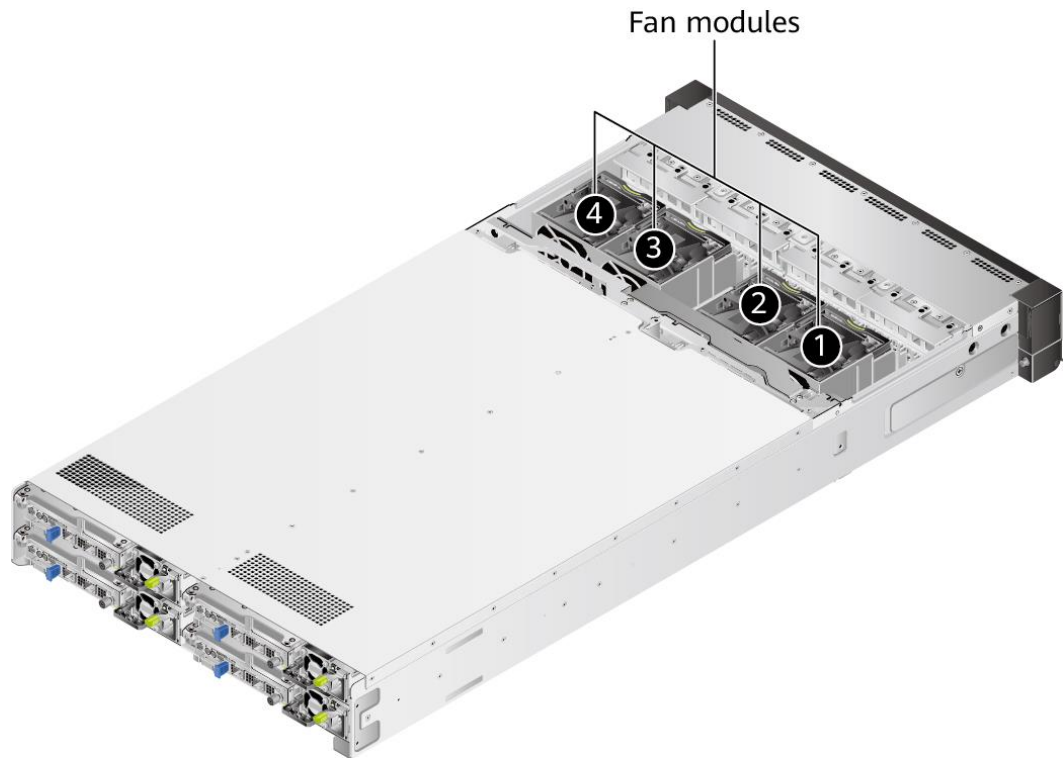

## 5.5 Middle Modules

The middle module consists of the drive cable module, fan management board, and middle column.

- Drive cable module supplies power to drives and provides data transmission channels.
- Fan management board supplies power to fans and drives fans.
- Middle column secures high-speed cable terminals.

**Figure 5-14** Middle module (8 x 2.5" drive configuration)

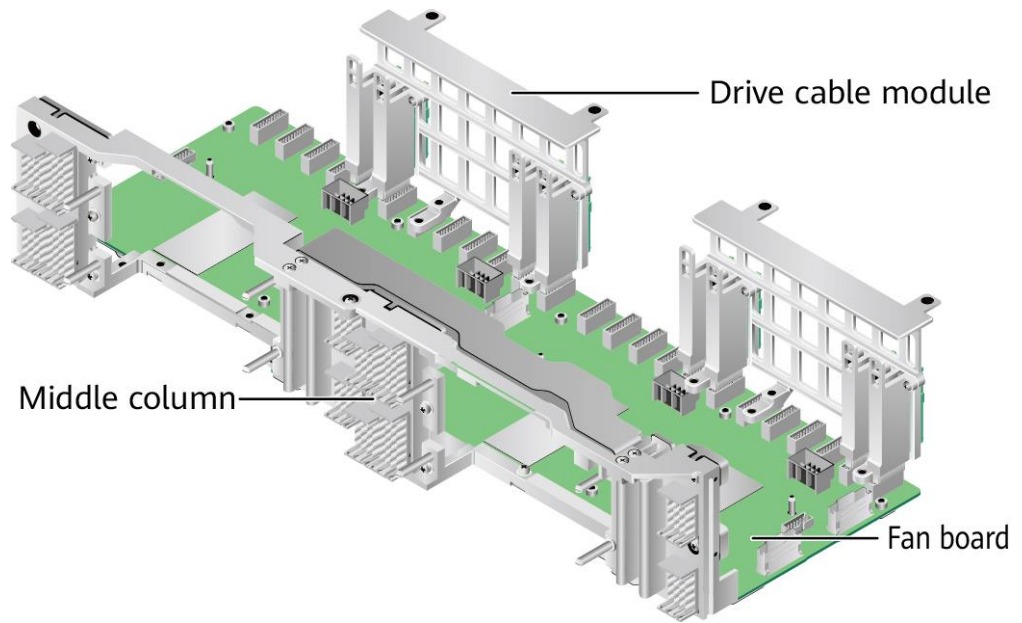

**Figure 5-15** Middle module (24 x 2.5" drive configuration)

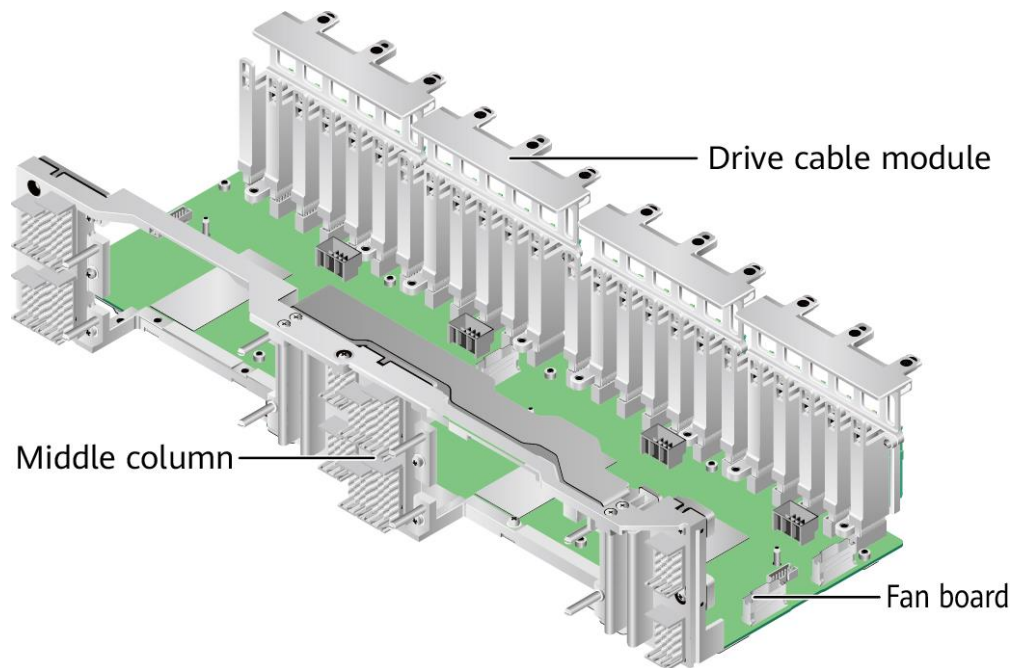

**Figure 5-16** Fan management board

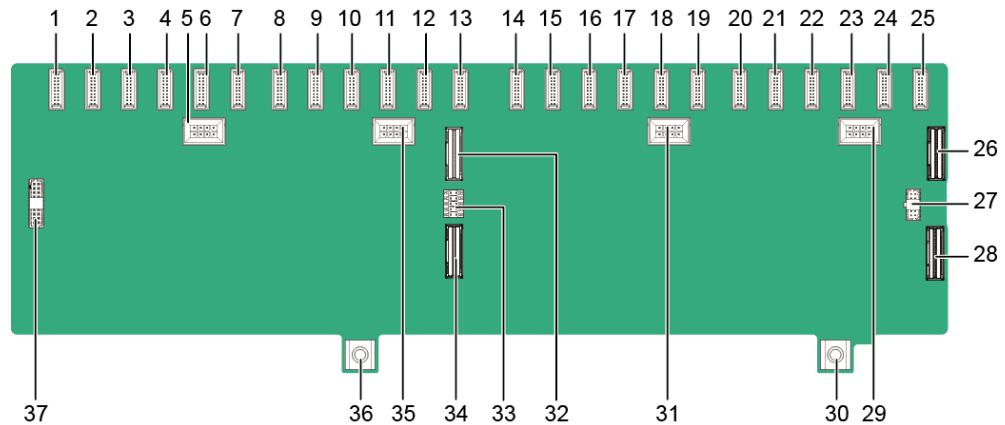

1	Drive cable module connector (J46)	2	Drive cable module connector (J43)
3	Drive cable module connector (J42)	4	Drive cable module connector (J41)
5	Fan module connector 4 (FAN_4/J42)	6	Drive cable module connector (J44)
7	Drive cable module connector (J45)	8	Drive cable module connector (J38)
9	Drive cable module connector (J35)	10	Drive cable module connector (J36)
11	Drive cable module connector (J37)	12	Drive cable module connector (J40)
13	Drive cable module connector (J39)	14	Drive cable module connector (J34)
15	Drive cable module connector (J31)	16	Drive cable module connector (J30)
17	Drive cable module connector (J29)	18	Drive cable module connector (J32)
19	Drive cable module connector (J33)	20	Drive cable module connector (J24)
21	Drive cable module connector (J26)	22	Drive cable module connector (J27)
23	Drive cable module connector (J28)	24	Drive cable module connector (J25)
25	Drive cable module connector (J23)	26	Server node 1 connector (J12)
27	Left mounting ear connector (J9)	28	Server node 2 connector (J13)



29	Fan module connector 1 (FAN_1/J62)	30	Power connector (J9)
31	Fan module connector 2 (FAN_2/J61)	32	Server node 3 connector (J21)
33	JTAG connector (J17)	34	Server node 4 connector (J22)
35	Fan module connector 3 (FAN_3/J60)	36	Power connector (J10)
37	Right mounting ear connector (J48)	-	-

## 5.6 Server Nodes

The X6000 V6 supports a maximum of four server nodes (XH321 V6 or XH321C V6).

- For details about the XH321 V6 server node, see *FusionServer XH321 V6 Server Node User Guide*.
- For details about the XH321C V6 server node, see *FusionServer XH321C V6 Server Node User Guide*.

**Figure 5-17** XH321 V6 appearance

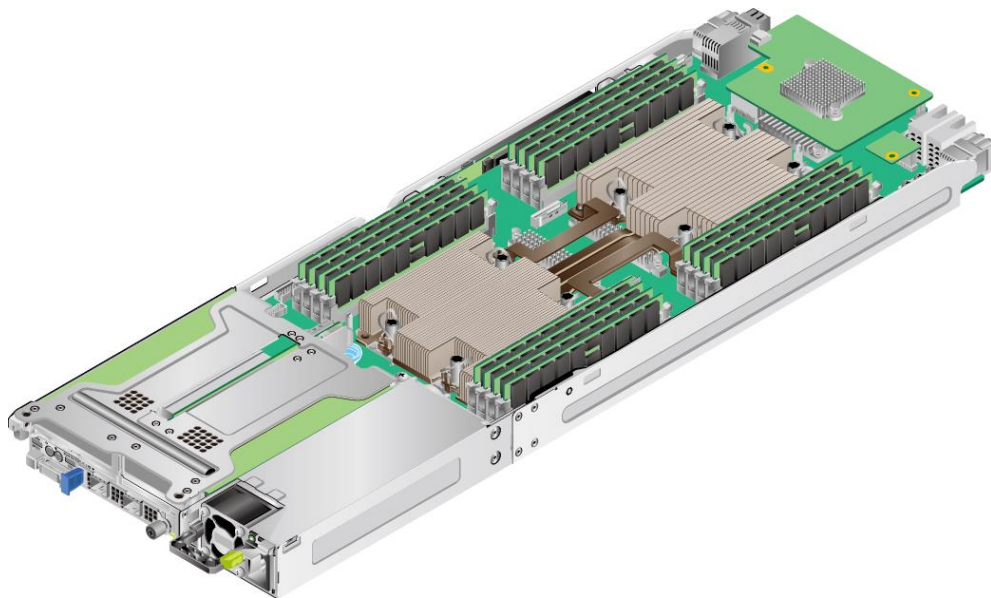

**Figure 5-18** XH321C V6 appearance

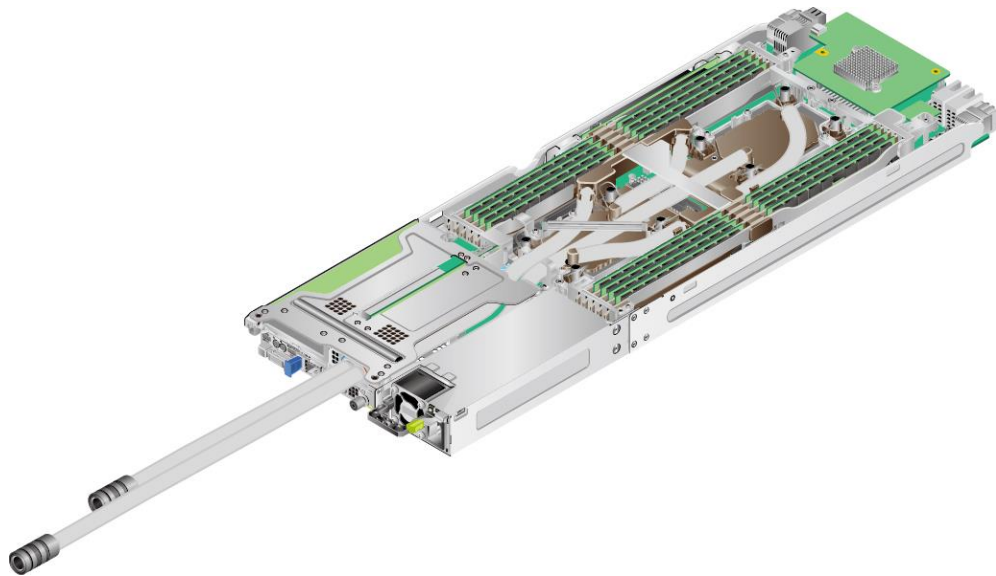

## 5.7 PSUs

- PSUs are installed in server nodes, so the power consumption of a server varies depending on the server configuration:
  - When two server nodes are configured, the PSUs work in 1+1 redundancy mode.
  - When four server nodes are configured, the PSUs work in 2+2 redundancy mode.
- PSUs of the same part number (P/N code) must be used in a server.
- The PSUs are protected against short circuit. Double-pole fuse is provided for the PSUs with dual input live wires.
- If the DC power supply is used, purchase the DC power supply that meets the requirements of the corresponding safety standards or the DC power supply that has passed the CCC certification.
- For details about the components that can be purchased, contact technical support.

**Figure 5-19** PSU positions

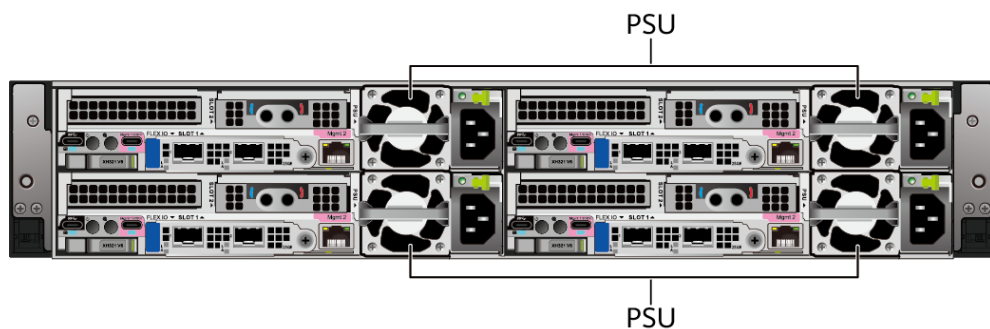

# 6 Product Specifications

- 6.1 [Technical Specifications](#)
- 6.2 [Environmental Specifications](#)
- 6.3 [Physical Specifications](#)

## 6.1 Technical Specifications

**Table 6-1** Technical specifications

Component	Description
Form factor	2U 4-node high-density server
Server nodes	<p>Supports a maximum of four server nodes, including XH321 V6 and XH321C V6 server nodes.</p> <p><b>NOTE</b> All server nodes in a chassis must have the same configurations.</p>
Storage	<p>Supports a variety of drive configurations. For details, see 5.3.1 Drive Configurations.</p> <ul style="list-style-type: none"> <li>• Supports hot swap of SAS/SATA/NVMe drives.</li> </ul> <p><b>NOTE</b> The NVMe drives support:</p> <ul style="list-style-type: none"> <li>• Before using the VMD function, contact technical support engineers of the OS vendor to check whether the OS supports the VMD function. If yes, check whether the VMD driver needs to be manually installed and check the installation method.</li> <li>• Surprise hot swap if the VMD function is enabled and the latest Intel VMD driver is installed.</li> <li>• Orderly hot swap if the VMD function is disabled.</li> <li>• If OS is installed on an NVMe SSD, BIOS can only be set to the UEFI mode.</li> </ul>
Fan modules	<ul style="list-style-type: none"> <li>• Provides four fan modules.</li> <li>• Supports N + 1 redundancy.</li> <li>• Supports hot swap (in non-stacking installation scenarios).</li> </ul>

Component	Description
Middle modules	Provides a maximum of 24-drive cable module connectors, four fan module connectors, and two mounting ear cable connectors.
Ports	<p>Supports a variety of ports.</p> <ul style="list-style-type: none"> <li>• Ports on the front panel:                             <ul style="list-style-type: none"> <li>– Two USB 2.0 ports</li> <li>– One DB15 VGA port</li> </ul> </li> <li>• Ports on the rear panel:                             <ul style="list-style-type: none"> <li>– For details about XH321 V6, see <i>FusionServer XH321 V6 Server Node User Guide</i>.</li> <li>– For details about XH321C V6, see <i>FusionServer XH321C V6 Server Node User Guide</i>.</li> </ul> </li> </ul>

## 6.2 Environmental Specifications

**Table 6-2** Environmental specifications

Item	Description
Temperature	<ul style="list-style-type: none"> <li>• Operating temperature: 5°C to 35°C (41°F to 95°F) (ASHRAE Class A2/A1 compliant)</li> <li>• Storage temperature (within three months): –30°C to +60°C (–22°F to +140°F)</li> <li>• Storage temperature (within six months): –15°C to +45°C (5°F to 113°F)</li> <li>• Storage temperature (within one year): –10°C to +35°C (14°F to 95°F)</li> <li>• Maximum rate of temperature change: 20°C (36°F) per hour, 5°C (9°F) per 15 minutes</li> </ul> <p><b>NOTE</b>                      The highest operating temperature varies depending on the server configuration. For details, see A.2 Operating Temperature Limitations.</p>
Relative Humidity (RH, Non-Condensing)	<ul style="list-style-type: none"> <li>• Operating humidity: 8% to 90%</li> <li>• Storage humidity (within six months): 5% to 85%</li> <li>• Storage humidity (within one year): 20% to 75%</li> <li>• Maximum humidity change rate: 20%/h</li> </ul>
Air volume	≥350CFM
Operating altitude	<p>≤ 3050 m (10006.44 ft)</p> <ul style="list-style-type: none"> <li>• If the server complies with ASHRAE Classes A1 and A2, the maximum operating temperature decreases by 1°C (1.8°F) for every increase of 300 m (984.25 ft) in altitude above 900 m (2952.76 ft).</li> </ul>

Item	Description
	<ul style="list-style-type: none"> <li>HDDs cannot be used at an altitude of over 3,050 m (10,006.44 ft).</li> </ul>
Corrosive air pollutant	Maximum corrosion product thickness growth rate: <ul style="list-style-type: none"> <li>Copper corrosion rate test: 300 Å/month (meeting level G1 requirements of the ANSI/ISA-71.04-2013 standard on gaseous corrosion)</li> <li>Silver corrosion rate test: 200 Å/month</li> </ul>
Particle pollutant	<ul style="list-style-type: none"> <li>The equipment room environment meets the requirements of ISO 14664-1 Class 8.</li> <li>There is no explosive, conductive, magnetic, or corrosive dust in the equipment room.</li> </ul> <p><b>NOTE</b>                      It is recommended that the particulate pollutants in the equipment room be monitored by a professional organization.</p>
Acoustic noise	The data listed in the following is the declared A-weighted sound power level (LWAd) and declared average bystander position A-weighted sound pressure level (LpAm) when the server is operating in a 23°C (73.4°F) ambient environment. Noise emissions are measured in accordance with ISO 7999 (ECMA 74) and declared in accordance with ISO 9296 (ECMA 109). <p>Idle:</p> <ul style="list-style-type: none"> <li>LWAd: 6.55 Bels</li> <li>LpAm: 51.2 dBA</li> </ul> <p>Operating:</p> <ul style="list-style-type: none"> <li>LWAd: 7.24 Bels</li> <li>LpAm: 58.1 dBA</li> </ul> <p><b>NOTE</b>                      Actual sound levels generated during server operation vary depending on server configuration, load, and ambient temperature.</p>

## 6.3 Physical Specifications

**Table 6-3** Physical specifications

Category	Description
Dimensions (H x W x D)	<ul style="list-style-type: none"> <li>86.1mm×447mm×900mm</li> </ul> <p><b>NOTE</b>                      The chassis depth refers to the horizontal distance from the front panel of the chassis to the I/O board of the server node.</p>
Installation Space	<ul style="list-style-type: none"> <li>Requirements for cabinet installation:                              Cabinet compliant with the International Electrotechnical</li> </ul>

Category	Description
	<p>Commission (IEC) 297 standard</p> <ul style="list-style-type: none"> <li>- Cabinet width: 447 mm (17.60 in.)</li> <li>- Cabinet depth <math>\geq</math> 1100 mm (43.31 in.)</li> </ul> <ul style="list-style-type: none"> <li>• Requirements for liquid-cooled cabinet installation:                      Use X6000 V6 1225 mm (48.23 in.) liquid-cooled cabinet. A liquid-cooled door is optional. The total depth of the cabinet with a liquid-cooled door is 1375 mm (54.13 in.).</li> <li>• Requirements for guide rail installation:                             <ul style="list-style-type: none"> <li>- L-shaped guide rails: For details about the installation requirements, contact technical support.</li> <li>- Static rail kit: applies to cabinets with a distance of 590 mm to 900 mm (23.22 in. to 35.43 in.) between the front and rear mounting bars.</li> </ul> </li> </ul> <p><b>NOTE</b>                      For a 1100 mm deep cabinet, a distance of 70 mm to 110 mm (2.75 in. to 4.33 in.) between the front mounting bar and the front cabinet door is recommended.</p>
Weight in full configuration	<ul style="list-style-type: none"> <li>• 8 x 2.5" drive configuration                             <ul style="list-style-type: none"> <li>- Net weight of a fully configured XH321 V6 server: 40.5 kg (89.28 lb)</li> </ul> </li> <li>• 24 x 2.5" drive configuration                             <ul style="list-style-type: none"> <li>- Net weight of a fully configured XH321 V6 server: 43.7 kg (96.34 lb)</li> </ul> </li> <li>• Packing weight: 13.5 kg (29.76 lb)</li> </ul>
Power Consumption	<p>The power consumption parameters vary with server configurations, including the configurations complying with energy-related products (ErP) requirements. For details, consult the local sales representative.</p>

# 7 Software and Hardware Compatibility

---

For details about the OS and hardware, contact technical support.

---

## NOTICE

- If incompatible components are used, the device may be abnormal. This fault is beyond the scope of technical support and warranty.
  - The performance of servers is closely related to application software, basic middleware software, and hardware. The slight differences of the application software, middleware basic software, and hardware may cause performance inconsistency between the application layer and test software layer.
  - If the customer has requirements on the performance of specific application software, contact technical support to apply for POC tests in the pre-sales phase to determine detailed software and hardware configurations.
  - If the customer has requirements on hardware performance consistency, specify the specific configuration requirements (for example, specific drive models, RAID controller cards, or firmware versions) in the pre-sales phase.
-

# 8 Safety Instructions

---

## 8.1 Security

## 8.2 Maintenance and Warranty

## 8.1 Security

### General Statement

- Comply with local laws and regulations when installing devices. These Safety Instructions are only a supplement.
- The "DANGER", "WARNING", and "CAUTION" information in this document does not represent all the safety instructions, but supplements to the safety instructions.
- Observe all safety instructions provided on device labels.
- Only qualified personnel are allowed to perform special tasks, such as high-voltage operations and driving a forklift.
- This product is a Class A device. Take protective measures before operating this product in a residential area as it is likely to cause radio interference.

### Personal Safety

- Only personnel certified or authorized are allowed to install equipment.
- Discontinue any dangerous operations and take protective measures. Report anything that could cause personal injury or device damage to a project supervisor.
- Do not move devices or install racks and power cables in hazardous weather conditions.
- For lifting or carrying hardware, ensure load limits and manpower provisions conform to legal specifications. Check the maximum device weight and arrange required personnel.
- Wear clean protective gloves, ESD clothing, a protective hat, and protective shoes, as shown in Figure 8-1.



**Figure 8-1** Safety work wear

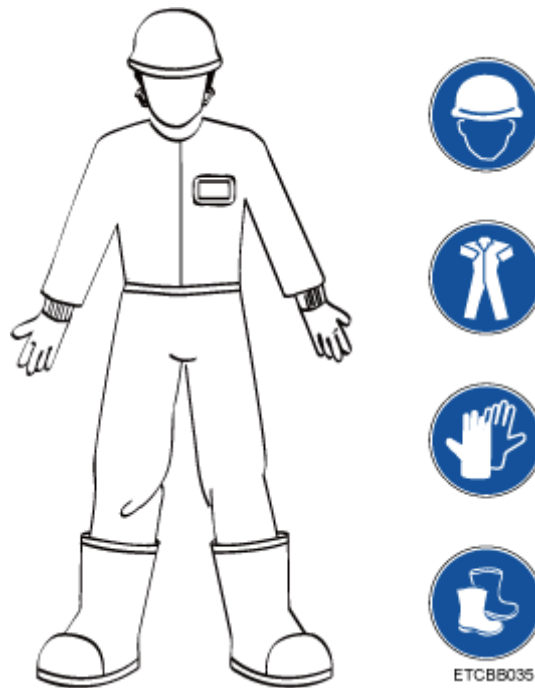

- Before touching a device, wear ESD clothing and gloves (or wrist strap), and remove any conductive objects (such as watches and jewelry). Figure 8-2 shows conductive objects that must be removed before you touch a device.

**Figure 8-2** Removing conductive objects



Figure 8-3 shows how to wear an ESD wrist strap.

- Put your hands into the ESD wrist strap.
- Tighten the strap buckle and ensure that the ESD wrist strap is in contact with your skin.
- Insert the ground terminal attached to the ESD wrist strap into the jack on the grounded rack or chassis.

**Figure 8-3** Wearing an ESD Wrist Strap

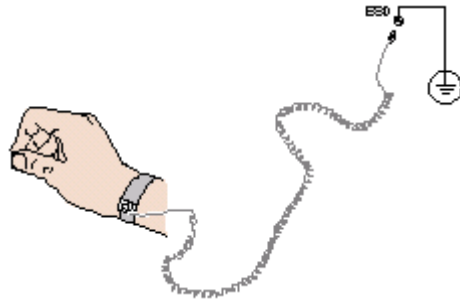

- Exercise caution when using tools.
- If the installation position of a device is higher than the shoulders of the installation personnel, use a vehicle such as a lift to facilitate installation. Prevent the device from falling down and causing personal injury or damage to the device.
- The equipment is powered by high-voltage power sources. Direct or indirect contact (especially through damp objects) with high-voltage power sources may result in serious injury or death.
- Ground the equipment before powering it on. Otherwise, personal injury may be caused by high electricity leakage.
- Do not use the ladder unsupervised. Have someone else hold the ladder steady to prevent accidents.
- Do not look into optical ports without eye protection.

## Device Security

- Use the recommended power cables at all times.
- Power cables are used only for dedicated servers. Do not use them for other devices.
- Before operating equipment, wear ESD clothes and gloves to prevent electrostatic-sensitive devices from being damaged by ESD.
- When moving a device, hold the bottom of the device. Do not hold the handles of the installed modules, such as the PSUs, fan modules, drives, and the mainboard. Handle devices with care.
- Exercise caution when using tools.
- Connect the primary and secondary power cables to different power distribution units (PDUs) to ensure reliable system operation.
- Ground a device before powering it on. Otherwise, high leakage current may cause device damage.

## Transportation Precautions

Contact the manufacturer for precautions before attempting transportation.

Transportation precautions include but are not limited to:

- The logistics company engaged to transport the device must be reliable and comply with international standards for transporting electronics. Ensure that the device being transported is always kept upright. Take necessary precautions to prevent collisions, corrosion, package damage, damp conditions and pollution.

- Transport each device in its original packaging.
- If the original packaging is unavailable, package heavy, bulky parts (such as chassis and blades) and fragile parts (such as PCIe cards and optical modules) separately.

 **NOTE**

For details about the components supported by the server, contact the local sales representatives.

- Power off all devices before transportation.

## Maximum Weight Carried by a Person

 **CAUTION**

Comply with local regulations for the maximum load per person.

Table 8-1 lists the maximum weight one person is permitted to carry as stipulated by a number of organizations.

**Table 8-1** Maximum weight carried by per person

Organization Name	Weight (kg/lb)
European Committee for Standardization (CEN)	25/55.13
International Organization for Standardization (ISO)	25/55.13
National Institute for Occupational Safety and Health (NIOSH)	23/50.72
Health and Safety Executive (HSE)	25/55.13
General Administration of Quality Supervision, Inspection and Quarantine of the People's Republic of China (AQSIQ)	<ul style="list-style-type: none"> <li>• Male: 15/33.08</li> <li>• Female: 10/22.05</li> </ul>

For more information about safety instructions, see *Server Safety Information*.

## 8.2 Maintenance and Warranty

For details about maintenance, consult the local sales representative.

For details about warranty policies, consult the local sales representative.

# 9 System Management

---

## 9.1 iBMC

### 9.2 Server Management System

## 9.1 iBMC

The intelligent Baseboard Management Controller (iBMC) provides various management functions.

- Various management interfaces  
The iBMC provides the following standard interfaces to meet various system integration requirements:
  - DCMI 1.5 interface
  - IPMI 1.5/IPMI 2.0 interface
  - CLI
  - Redfish interface
  - HTTPS
  - SNMP
- Fault detection and alarm management  
Faults can be detected and rectified in advance to ensure 24/7 stable running of the device.
  - The iBMC allows screenshots and videos to be created when the system breaks down, facilitating cause analysis of the system breakdown.
  - The iBMC offers screen snapshots and videos, simplifying routine preventive maintenance, recording, and auditing.
  - The Fault Diagnose Management (FDM) function supports component-based precise fault diagnosis, facilitating component fault locating and replacement.
  - The iBMC supports the reporting of alarms through syslog packets, trap packets, and emails, helping the upper-layer NMS to collect the fault information about the server.
- Security management
  - Software image backup improves system security. Even if the running software breaks down, the system can be started from the backup image.

- Diversified user security control interfaces are provided to ensure user login security.
- Multiple types of certificates can be imported and replaced to ensure data transmission security.
- System maintenance interface
  - The virtual KVM and virtual media functions facilitate remote maintenance.
  - Out-of-band RAID monitoring and configuration are supported to improve RAID configuration efficiency and management capability.
  - Smart Provisioning provides a convenient operation interface for installing the OS, configuring RAID, and performing the upgrade without a CD-ROM.
- Various network protocols
  - The NTP synchronizes network time to optimize time configuration.
  - The iBMC supports domain name system (DNS) and Lightweight Directory Application Protocol (LDAP) to implement domain management and directory service.
- Intelligent power management
  - The power capping technology helps you easily improve deployment density.
  - The iBMC uses dynamic power saving to reduce operational expenditure (OPEX).
- License management
 

By managing licenses, you can use the features of the iBMC advanced edition in authorization mode.

Compared with the standard edition, the iBMC advanced edition provides more advanced features, such as:

  - Redfish-enabled OS deployment
  - Redfish-enabled original data collection for intelligent diagnosis

## 9.2 Server Management System

The entire server management system consists of iBMCs on each server node. Table 9-1 lists main features of the server management system.

**Table 9-1** Features of the management system

Feature	Description
Management port	Supports the following management ports integrated with any standard management system: <ul style="list-style-type: none"> <li>• IPMI</li> <li>• CLI</li> <li>• WebUI</li> </ul>
Fault detection	Detects and accurately locates faults in server and node components.
Alarm management	Supports alarm management and reports alarms in various ways, such as the syslog service, to ensure uninterrupted 24/7 system operation.

Feature	Description
Asset management	Supports intelligent asset management.
Intelligent power management	Uses the power capping technology to increase deployment density and uses the dynamic energy saving technology to lower the operation and maintenance costs.
Aggregation port	The management port of each server node is an aggregation port, which can be connected to the iBMC of another node. This reduces the cabling of the management network and shortens the system maintenance time.

# 10 Certifications

Country/Region	Certification	Standard
Europe	WEEE	2012/19/EU
Europe	RoHS	2011/65/EU, EN 50581: 2012
Europe	REACH	EC NO.1907/2006
Europe	CE	Safety: EN 60950-1:2006+A11:2009+A1:2010+A12:2011 Electromagnetic compatibility (EMC): <ul style="list-style-type: none"> <li>• EN 55022: 2010</li> <li>• CISPR 22: 2008</li> <li>• EN 55024: 2010</li> <li>• CISPR 24: 2010</li> <li>• ETSI EN 300 386 V1.6.1: 2012</li> <li>• ETSI ES 201 468 V1.3.1: 2005</li> </ul>
China	CCC	GB4943.1-2011 GB9254-2008(Class A) GB17625.1-2012
China	RoHS	SJ/T-11363-20006 SJ/T-11364-20006 GB/T 26572-2011
Japan	VCCI	VCCI V-4: 2012

# A Appendix

## A.1 Product SN

The serial number (SN) on the slide-out label plate uniquely identifies a device. The SN is required when you contact technical support.

**Figure A-1** SN example



**Table A-1** SN description

SN	Description
1	ESN ID (two digits), which can only be <b>21</b> .
2	Material ID (eight characters), that is, the processing code.
3	Vendor code (two digits), that is, the code of the processing place.
4	<p>Year and month (two characters).</p> <ul style="list-style-type: none"> <li>The first character indicates the year.                             <ul style="list-style-type: none"> <li>Digits 1 to 9 indicate years 2001 to 2009, respectively.</li> <li>Letters A to H indicate years 2010 to 2017, respectively.</li> <li>Letters J to N indicate years 2018 to 2022, respectively.</li> <li>Letters P to Y indicate years 2023 to 2032, respectively.</li> </ul> </li> </ul> <p><b>NOTE</b></p> <p>The years from 2010 are represented by upper-case letters excluding I, O, and Z because the three letters are similar to the digits 1, 0, and 2.</p> <ul style="list-style-type: none"> <li>The second character indicates the month.                             <ul style="list-style-type: none"> <li>Digits 1 to 9 indicate January to September, respectively.</li> </ul> </li> </ul>



SN	Description
	- Letters A to C indicate October to December, respectively.
5	Serial number (six digits).
6	RoHS compliance (one character). <b>Y</b> indicates RoHS compliant.
7	Board model, that is, product name.

## A.2 Operating Temperature Limitations

**Table A-2** Operating temperature limitations (server with 8 x 2.5" SAS/SATA drives)

Drive Configuration	Number of Standard PCIe Cards	Number of OCP 3.0 Network Adapters	Number of RAID Controller Cards	Fan Configuration	CPU Configuration	Maximum Temperature
0 < drives ≤ 8	2	0	0	8080+	205 W < P ≤ 270 W	35°C
					P ≤ 205W	35°C
	2	0	1	8080+	205 W < P ≤ 270 W	35°C
					P ≤ 205W	35°C
	2	1	1	8080+	205 W < P ≤ 270 W	32°C
					P ≤ 205W	35°C
0 < drives ≤ 8	2	0	0	8080	205 W < P ≤ 270 W	32°C
					P ≤ 205W	35°C
	2	0	1	8080	205 W < P ≤ 270 W	30°C
					P ≤ 205W	35°C
	2	1	1	8080	205 W < P ≤ 270 W	29°C
					P ≤ 205W	35°C
<ul style="list-style-type: none"> <li>• By default, all configurations include optical modules.</li> <li>• XH321 V6 does not support the 8368Q processor.</li> <li>• When the server is configured with high-frequency, less-core processors such as 6346 and 6354, the supported operating temperature decreases. For details, consult the local</li> </ul>						

Drive Configuration	Number of Standard PCIe Cards	Number of OCP 3.0 Network Adapters	Number of RAID Controller Cards	Fan Configuration	CPU Configuration	Maximum Temperature
sales representatives. <ul style="list-style-type: none"> <li>For configurations not listed in the table, the operating temperature range is 5°C (41°F) to 35°C (95°F). For special configuration and temperature requirements, contact technical support.</li> </ul>						

**Table A-3** Operating temperature limitations (server with 24 x 2.5" SAS/SATA drives)

Drive Configuration	Number of Standard PCIe Cards	Number of OCP 3.0 Network Adapters	Number of RAID Controller Cards	Fan Configuration	CPU Configuration	Maximum Temperature	
16 ≤ drives ≤ 24	2	0	0	8080+	185 W < P ≤ 205 W	35°C	
					P ≤ 185W	35°C	
	2	0	1	8080+	185 W < P ≤ 205 W	35°C	
					P ≤ 185W	35°C	
	2	1	1	8080+	185 W < P ≤ 205 W	35°C	
					P ≤ 185W	35°C	
	2	0	0	8080	185 W < P ≤ 205 W	35°C	
					P ≤ 185W	35°C	
	2	0	1	8080	185 W < P ≤ 205 W	33°C	
					P ≤ 185W	35°C	
	2	1	1	8080	185 W < P ≤ 205 W	32°C	
					P ≤ 185W	35°C	
	<ul style="list-style-type: none"> <li>By default, all configurations include optical modules.</li> <li>When the server is configured with high-frequency, less-core processors such as 6346</li> </ul>						

Drive Configuration	Number of Standard PCIe Cards	Number of OCP 3.0 Network Adapters	Number of RAID Controller Cards	Fan Configuration	CPU Configuration	Maximum Temperature
and 6354, the supported operating temperature decreases. For details, consult the local sales representatives.						
<ul style="list-style-type: none"> <li>For configurations not listed in the table, the operating temperature range is 5°C (41°F) to 35°C (95°F). For special configuration and temperature requirements, contact technical support.</li> </ul>						

**Table A-4** Operating temperature limitations (server with 24 x 2.5" SAS/SATA/NVMe drives)

Drive Configuration	Number of Standard PCIe Cards	Number of OCP 3.0 Network Adapters	Number of RAID Controller Cards	Fan Configuration	CPU Configuration	Maximum Temperature
16 ≤ drives ≤ 24	2	0	0 <sup>a</sup>	8080+	185 W < P ≤ 205 W	35°C
					P ≤ 185W	35°C
	2	1	0 <sup>a</sup>	8080+	185 W < P ≤ 205 W	34°C
					P ≤ 185W	35°C
	2	0	0 <sup>a</sup>	8080	185 W < P ≤ 205 W	32°C
					P ≤ 185W	35°C
	2	1	0 <sup>a</sup>	8080	185 W < P ≤ 205 W	31°C
					P ≤ 185W	35°C
<ul style="list-style-type: none"> <li>a: When NVMe drives are used, and the RAID controller card is configured for SAS/SATA drives, the supported operating temperature may decrease.</li> <li>By default, all configurations include optical modules.</li> <li>When the server is configured with high-frequency, less-core processors such as 6346 and 6354, the supported operating temperature decreases. For details, consult the local sales representatives.</li> <li>For configurations not listed in the table, the operating temperature range is 5°C (41°F) to 35°C (95°F). For special configuration and temperature requirements, contact technical support.</li> </ul>						

**Table A-5** X6000 V6 server heat dissipation and air volume requirements

X6000 V6 Power	Environment and Air Volume Requirement of a Single-Chassis Server
3000W-4000W	<ul style="list-style-type: none"> <li>• Air inlet temperature: <math>\leq 35^{\circ}\text{C}</math> (<math>95^{\circ}\text{F}</math>)</li> <li>• Air volume supplied in the equipment room for a single device: <math>\geq 350</math> CFM</li> <li>• Cooling capacity supplied in the equipment room for a single device: <math>\geq 4000</math> W</li> </ul>
Lower than 3000 W	<ul style="list-style-type: none"> <li>• Air inlet temperature: <math>\leq 35^{\circ}\text{C}</math> (<math>95^{\circ}\text{F}</math>)</li> <li>• Air volume supplied in the equipment room for a single device:                             <ul style="list-style-type: none"> <li>- 8080 fans: <math>\geq 270</math> CFM</li> <li>- 8080+ fans: <math>\geq 300</math> CFM</li> </ul> </li> <li>• Cooling capacity supplied in the equipment room for a single device: <math>\geq 3000</math> W</li> </ul>

### A.3 Nameplate

Certified Model	Description
X6000	Global

### A.4 RAS Features

The server supports a variety of Reliability, Availability, and Serviceability (RAS) features. You can configure these features for better performance.

For details about the RAS features, see *FusionServer Ice Lake Platform RAS Technical White Paper*.

### A.5 Sensor List

- For details about XH321 V6, see *FusionServer XH321 V6 Server Node Technical White Paper*.
- For details about XH321C V6, see *FusionServer XH321C V6 Server Node Technical White Paper*.

---

# B Glossary

---

## B.1 A-E

### B

<b>BMC</b>	The baseboard management controller (BMC) complies with the Intelligent Platform Management Interface (IPMI). It collects, processes, and stores sensor signals, and monitors the operating status of components. The BMC provides the hardware status and alarm information about the managed objects to the upper-level management system, so that the management system can manage the objects.
------------	--

### E

<b>ejector lever</b>	A part on the panel of a device used to facilitate installation or removal of the device.
<b>Ethernet</b>	A baseband local area network (LAN) architecture developed by Xerox Corporation by partnering with Intel and DEC. Ethernet uses the Carrier Sense Multiple Access/Collision Detection (CSMA/CD) access method and allows data transfer over various cables at 10 Mbit/s. The Ethernet specification is the basis for the IEEE 802.3 standard.

## B.2 F-J

### G

<b>Gigabit Ethernet (GE)</b>	An extension and enhancement of traditional shared media Ethernet standards. It is compatible with 10 Mbit/s and 100 Mbit/s Ethernet and complies with IEEE 802.3z standards.
------------------------------	---

## H

<b>hot swap</b>	Replacing or adding components without stopping or shutting down the system.
-----------------	--

## B.3 K-O

### K

<b>KVM</b>	A hardware device that provides public video, keyboard and mouse (KVM).
------------	---

## B.4 P-T

### P

<b>panel</b>	An external component (including but not limited to ejector levers, indicators, and ports) on the front or rear of the server. It seals the front and rear of the chassis to ensure optimal ventilation and electromagnetic compatibility (EMC).
<b>Peripheral Component Interconnect Express (PCIe)</b>	A computer bus PCI, which uses the existing PCI programming concepts and communication standards, but builds a faster serial communication system. Intel is the main sponsor for PCIe. PCIe is used only for internal interconnection. A PCI system can be transformed to a PCIe system by modifying the physical layer instead of software. PCIe delivers a faster speed and can replace almost all AGP and PCI buses.
<b>Proportional-integral-derivative</b>	Proportional-integral-derivative (PID) algorithm is the most common control algorithm in industry. In PID control, the algorithm calculates the proportion, integral, derivative response, and the sum of the three, thus to calculate the actual output.

### R

<b>redundancy</b>	A mechanism that allows a backup device to automatically take over services from a faulty device to ensure uninterrupted running of the system.
<b>redundant array of independent disks (RAID)</b>	A storage technology that combines multiple physical drives into a logical unit for the purposes of data redundancy and performance improvement.

## S

<b>server</b>	A special computer that provides services for clients over a network.
<b>system event log (SEL)</b>	Event records stored in the system used for subsequent fault diagnosis and system recovery.

## B.5 U-Z

## U

<b>U</b>	A unit defined in International Electrotechnical Commission (IEC) 60297-1 to measure the height of a cabinet, chassis, or subrack. 1 U = 44.45 mm
<b>UltraPath Interconnect (UPI)</b>	A point-to-point processor interconnect developed by Intel.

---

# C Acronyms and Abbreviations

---

## C.1 A-E

### A

<b>AC</b>	alternating current
<b>AES</b>	Advanced Encryption Standard New Instruction Set
<b>ARP</b>	Address Resolution Protocol
<b>AVX</b>	Advanced Vector Extensions

### B

<b>BBU</b>	backup battery unit
<b>BIOS</b>	Basic Input/Output System
<b>BMC</b>	baseboard management controller

### C

<b>CD</b>	calendar day
<b>CE</b>	Conformite Europeenne
<b>CIM</b>	Common Information Model
<b>CLI</b>	command-line interface

### D

<b>DC</b>	direct current
-----------	----------------



<b>DDR4</b>	Double Data Rate 4
<b>DDDC</b>	double device data correction
<b>DEMT</b>	Dynamic Energy Management Technology
<b>DIMM</b>	dual in-line memory module
<b>DRAM</b>	dynamic random-access memory
<b>DVD</b>	digital video disc

## E

<b>ECC</b>	error checking and correcting
<b>ECMA</b>	European Computer Manufacturer Association
<b>EDB</b>	Execute Disable Bit
<b>EN</b>	European Efficiency
<b>ERP</b>	enterprise resource planning
<b>ETS</b>	European Telecommunication Standards

## C.2 F-J

### F

<b>FB-DIMM</b>	Fully Buffered DIMM
<b>FC</b>	Fiber Channel
<b>FCC</b>	Federal Communications Commission
<b>FCoE</b>	Fibre Channel over Ethernet
<b>FTP</b>	File Transfer Protocol

### G

<b>GE</b>	Gigabit Ethernet
<b>GPIO</b>	General Purpose Input/Output
<b>GPU</b>	graphics processing unit

## H

<b>HA</b>	high availability
<b>HDD</b>	hard disk drive
<b>HPC</b>	high-performance computing
<b>HTTP</b>	Hypertext Transfer Protocol
<b>HTTPS</b>	Hypertext Transfer Protocol Secure

## I

<b>iBMC</b>	intelligent baseboard management controller
<b>IC</b>	Industry Canada
<b>ICMP</b>	Internet Control Message Protocol
<b>IDC</b>	Internet Data Center
<b>IEC</b>	International Electrotechnical Commission
<b>IEEE</b>	Institute of Electrical and Electronics Engineers
<b>IGMP</b>	Internet Group Message Protocol
<b>IOPS</b>	input/output operations per second
<b>IP</b>	Internet Protocol
<b>IPC</b>	Intelligent Power Capability
<b>IPMB</b>	Intelligent Platform Management Bus
<b>IPMI</b>	Intelligent Platform Management Interface

## C.3 K-O

### K

<b>KVM</b>	keyboard, video, and mouse
------------	----------------------------

### L

<b>LC</b>	Lucent Connector
<b>LRDIMM</b>	load-reduced dual in-line memory module
<b>LED</b>	light emitting diode

<b>LOM</b>	LAN on motherboard
------------	--------------------

## M

<b>MAC</b>	media access control
<b>MMC</b>	module management controller

## N

<b>NBD</b>	next business day
<b>NC-SI</b>	Network Controller Sideband Interface

## O

<b>OCP</b>	Open Compute Project
------------	----------------------

## C.4 P-T

### P

<b>PCIe</b>	Peripheral Component Interconnect Express
<b>PDU</b>	power distribution unit
<b>PHY</b>	physical layer
<b>PID</b>	Proportional-integral-derivative
<b>PMBUS</b>	power management bus
<b>POK</b>	Power OK
<b>PWM</b>	pulse-width modulation
<b>PXE</b>	Preboot Execution Environment

### R

<b>RAID</b>	redundant array of independent disks
<b>RAS</b>	reliability, availability and serviceability

<b>RDIMM</b>	registered dual in-line memory module
<b>REACH</b>	Registration Evaluation and Authorization of Chemicals
<b>RJ45</b>	registered jack 45
<b>RoHS</b>	Restriction of the Use of Certain Hazardous Substances in Electrical and Electronic Equipment

**S**

<b>SAS</b>	Serial Attached Small Computer System Interface
<b>SATA</b>	Serial Advanced Technology Attachment
<b>SCM</b>	supply chain management
<b>SDDC</b>	single device data correction
<b>SERDES</b>	serializer/deserializer
<b>SGMII</b>	serial gigabit media independent interface
<b>SMI</b>	serial management interface
<b>SMTP</b>	Simple Mail Transfer Protocol
<b>SNMP</b>	Simple Network Management Protocol
<b>SOL</b>	serial over LAN
<b>SONCAP</b>	Standards Organization of Nigeria-Conformity Assessment Program
<b>SSD</b>	solid-state drive
<b>SSE</b>	Streaming SIMD Extension

**T**

<b>TACH</b>	tachometer signal
<b>TBT</b>	Turbo Boost Technology
<b>TCG</b>	Trusted Computing Group
<b>TCM</b>	trusted cryptography module
<b>TCO</b>	total cost of ownership
<b>TDP</b>	thermal design power
<b>TELNET</b>	Telecommunication Network Protocol
<b>TET</b>	Trusted Execution Technology

<b>TFM</b>	TransFlash module
<b>TFTP</b>	Trivial File Transfer Protocol
<b>TOE</b>	TCP offload engine
<b>TPM</b>	trusted platform module

## C.5 U-Z

### U

<b>UDIMM</b>	unbuffered dual in-line memory module
<b>UEFI</b>	Unified Extensible Firmware Interface
<b>UID</b>	unit identification light
<b>UL</b>	Underwriter Laboratories Inc.
<b>UPI</b>	UltraPath Interconnect
<b>USB</b>	Universal Serial Bus

### V

<b>VCCI</b>	Voluntary Control Council for Interference by Information Technology Equipment
<b>VGA</b>	Video Graphics Array
<b>VLAN</b>	virtual local area network
<b>VRD</b>	voltage regulator-down

### W

<b>WEEE</b>	waste electrical and electronic equipment
<b>WSMAN</b>	Web Service Management