

### Overview

### HPE ProLiant XL170r Gen10 Server

The ProLiant XL170r Gen10 Server is a 1U half-width, 2P server with configuration options for:

- Performance and efficient CPUs -- Intel Xeon Scalable Family series processor options ranging from Bronze to Platinum with choices from 4-26 Cores, 1.7GHz – 3.6GHz CPU speed, and power ratings between 85-150 Watts
- 16 memory DIMM slots, DDR4 2666 MT/s HPE SmartMemory.
- 2 I/O slots for a choice of networking and clustering options including : 1Gb, 10Gb, 100Gb Ethernet, 100 Gb/s EDR InfiniBand, 100Gv/s Omni-Path, FibreChannel and options for either 1 PCIe (x16) slot plus a FlexibleLOM or 2 PCIe (x16) slots

The Apollo r2000 series chassis accommodates 4 independently serviceable ProLiant XL170r Gen10 servers with up to 80 servers in a 42U rack with 1 to 4 servers per chassis.

Rack scale power efficiency is easy with HPE Apollo Platform Manager for rack, chassis, server and component level management

**Front View**

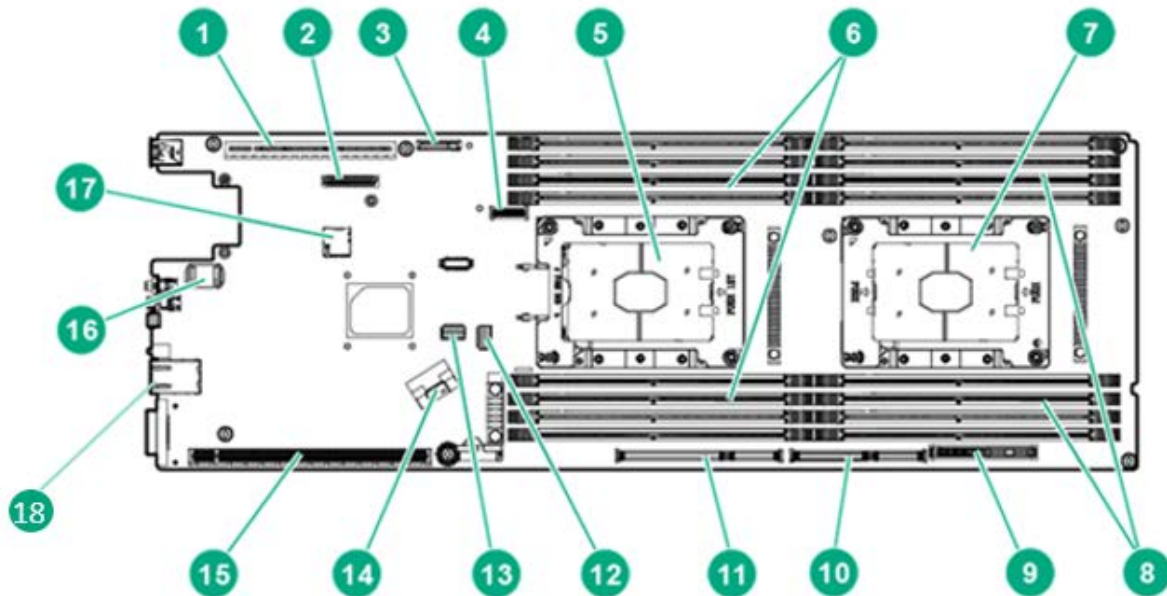

Item	Description	Item	Description
1	Primary riser slot 1	10	Secondary riser slot 4
2	mLOM connector	11	Secondary riser slot 3
3	System battery	12	Slimline connector (SATA x4)
4	M.2 SSD riser connector	13	System maintenance switch
5	Processor 1	14	Slimline connector (SATA x8)
6	DIMMs for processor 1	15	Secondary riser slot 2
7	Processor 2	16	TPM connector
8	DIMMs for processor 2	17	microSD slot
9	Bayonet board slot	18	iLO dedicated port

Overview

Rear View

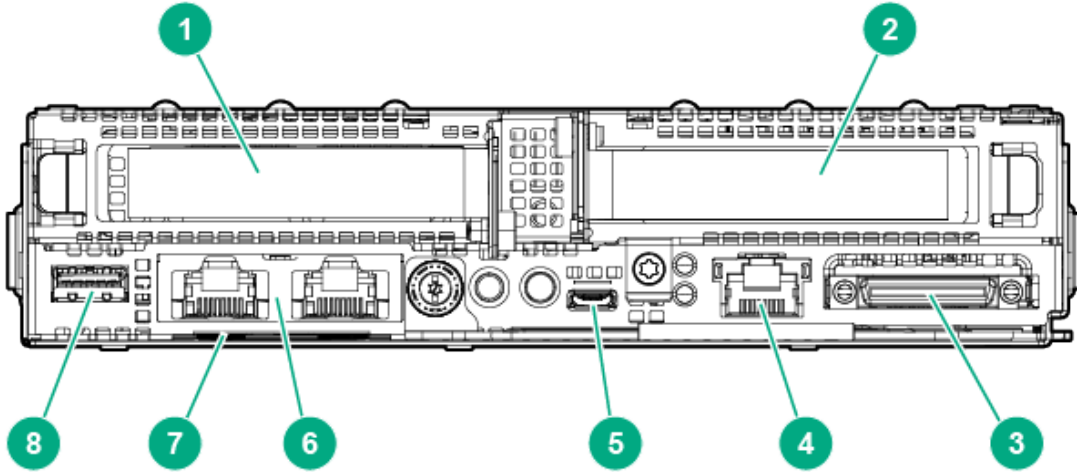

Item	Description
1	Primary riser (slot1)
2	Secondary riser (slot2)
3	SUV connector
4	Dedicated iLO port
5	iLO service port
6	mLOM module
7	Node serial number and iLO label pull tab
8	USB 3.0 connector

Single-slot left PCI riser cage assembly

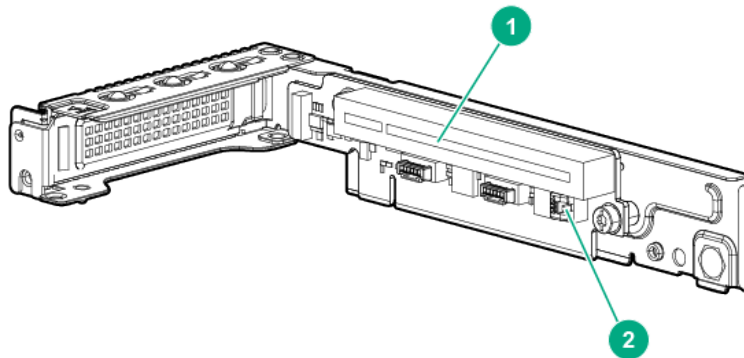

Item	Form factor	Slot number	Slot description
1	Low-profile PCIe card	1	PCIe3 x16 (16, 8, 4, 1) for Processor 1

Overview

Single-slot 1U node right PCI riser cage assembly

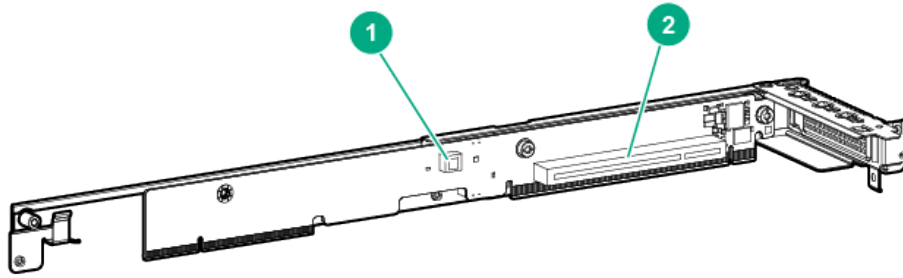

Item	Form factor	Slot number	Slot description
1	Low-profile PCIe card	1	PCIe3 x16 (16, 8, 4, 1) for Processor 1
2	N/A	N/A	Storage backup power connector

Single-slot 1U node right PCI riser cage assembly

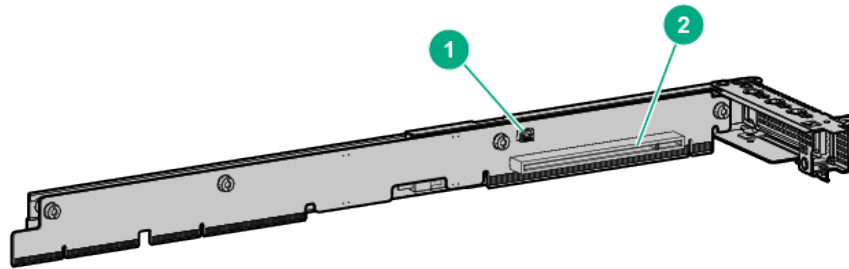

Item	Form factor	Slot number	Slot description
1	Low-profile PCIe card	2	PCIe3 x16 (16, 8, 4, 1) for Processor 2
2	N/A	N/A	Storage backup power connector

Overview

FlexibleLOM 1U node riser cage assembly

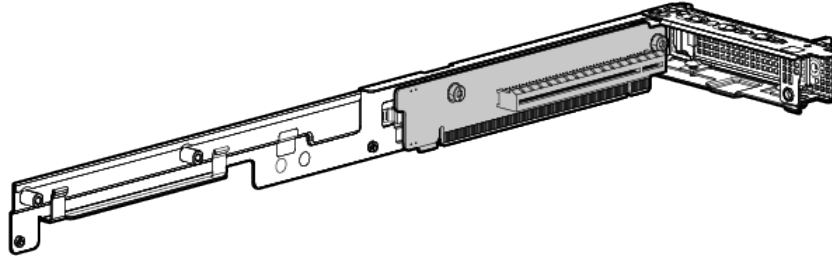

Item	Form factor	Slot number	Slot description
1	FlexibleLOM	FlexibleLOM slot	PCIe3 x16 for Processor 1

## Standard Features

**NOTE:** For the Standard Features shipped in the Factory Integrated Models, please see the "Configuration Information Factory Integrated Models" section.

### Processors

Intel Xeon Models	CPU				Power	QPI	DDR4 MT/s	Memory per socket
	Frequency	Cores	L3 Cache					
Platinum 8164 Processor	2.0 GHz	26	35.75 MB		150W	3 @ 10.4 GT/s	2666 MT/s	768 GB
Platinum 8160 Processor	2.1 GHz	24	33.00 MB		150W	3 @ 10.4 GT/s	2666 MT/s	768 GB
Platinum 8158 Processor	3.0 GHz	12	24.75 MB		150W	3 @ 10.4 GT/s	2666 MT/s	768 GB
Platinum 8156 Processor	3.6 GHz	4	16.50 MB		105W	3 @ 10.4 GT/s	2666 MT/s	768 GB
Platinum 8153 Processor	2.0 GHz	16	22.00 MB		125W	3 @ 10.4 GT/s	2666 MT/s	768 GB
Gold 6152 Processor	2.1 GHz	22	30.25 MB		140W	3 @ 10.4 GT/s	2666 MT/s	768 GB
Gold 6148 Processor	2.4 GHz	20	27.50 MB		150W	3 @ 10.4 GT/s	2666 MT/s	768 GB
Gold 6142 Processor	2.6 GHz	16	22.00 MB		150W	3 @ 10.4 GT/s	2666 MT/s	768 GB
Gold 6140 Processor	2.3 GHz	18	24.75 MB		140W	3 @ 10.4 GT/s	2666 MT/s	768 GB
Gold 6138 Processor	2.0 GHz	20	27.50 MB		125W	3 @ 10.4 GT/s	2666 MT/s	768 GB
Gold 6138F Processor	2.0 GHz	20	27.50 MB		135W	3 @ 10.4 GT/s	2666 MT/s	768 GB
Gold 6136 Processor	3.0 GHz	12	24.75 MB		150W	3 @ 10.4 GT/s	2666 MT/s	768 GB
Gold 6134 Processor	3.2 GHz	8	24.75 MB		130W	3 @ 10.4 GT/s	2666 MT/s	768 GB
Gold 6132 Processor	2.6 GHz	14	19.25 MB		140W	3 @ 10.4 GT/s	2666 MT/s	768 GB
Gold 6130 Processor	2.1 GHz	16	22.00 MB		125W	3 @ 10.4 GT/s	2666 MT/s	768 GB
Gold 6130F Processor	2.1 GHz	16	22.00 MB		135W	3 @ 10.4 GT/s	2666 MT/s	768 GB
Gold 6128 Processor	3.4 GHz	6	19.25 MB		115W	3 @ 10.4 GT/s	2666 MT/s	768 GB
Gold 6126 Processor	2.6 GHz	12	19.25 MB		125W	3 @ 10.4 GT/s	2666 MT/s	768 GB
Gold 6126F Processor	2.6 GHz	12	19.25 MB		135W	3 @ 10.4 GT/s	2666 MT/s	768 GB
Gold 5122 Processor	3.6 GHz	4	16.50 MB		105W	2 @ 10.4 GT/s	2400 MT/s	768 GB
Gold 5120 Processor	2.2 GHz	14	19.25 MB		105W	2 @ 10.4 GT/s	2400 MT/s	768 GB
Gold 5118 Processor	2.3 GHz	12	16.50 MB		105W	2 @ 10.4 GT/s	2400 MT/s	768 GB
Gold 5115 Processor	2.4 GHz	10	13.75 MB		85W	2 @ 10.4 GT/s	2400 MT/s	768 GB
Silver 4116 Processor	2.1 GHz	12	16.50 MB		85W	2 @ 9.6 GT/s	2400 MT/s	768 GB
Silver 4114 Processor	2.2 GHz	10	13.75 MB		85W	2 @ 9.6 GT/s	2400 MT/s	768 GB
Silver 4112 Processor	2.6 GHz	4	8.25 MB		85W	2 @ 9.6 GT/s	2400 MT/s	768 GB
Silver 4110 Processor	2.1 GHz	8	11.00 MB		85W	2 @ 9.6 GT/s	2400 MT/s	768 GB
Silver 4109T Processor	2.0 GHz	8	11.00 MB		70W	2 @ 9.6 GT/s	2400 MT/s	768 GB
Silver 4108 Processor	1.8 GHz	8	11.00 MB		85W	2 @ 9.6 GT/s	2400 MT/s	768 GB
Bronze 3106 Processor	1.7 GHz	8	11.00 MB		85W	2 @ 9.6 GT/s	2133 MT/s	768 GB
Bronze 3104 Processor	1.7 GHz	6	8.25 MB		85W	2 @ 9.6 GT/s	2133 MT/s	768 GB

## Standard Features

<b>Chipset</b>	HPE iLO 5 ASIC. Intel® C622 Chipset (Intel EY82C622 PCH) <b>NOTE:</b> For more information regarding Intel® chipsets, please see the following URL: <a href="http://www.intel.com/products/server/chipsets/">http://www.intel.com/products/server/chipsets/</a>					
<b>On System Management Processor</b>	HPE iLO 5 ASIC. <b>NOTE:</b> Read and learn more in the <a href="#">iLO QuickSpecs</a>					
<b>Memory</b>	Type	HPE SmartMemory DDR4 Load Reduced (LRDIMM), or Registered (RDIMM)				
	DIMM Slots Available	16 DIMM Slots available				
	Maximum (LRDIMM) (per server tray)	1.5TB				
	<b>NOTE:</b> HPE memory from previous generation servers are not fully compatible with the HPE ProLiant XL170r Gen10 Server.					
	<b>NOTE:</b> To realize the performance memory capabilities listed in this document, HPE SmartMemory is required. For additional information, please see the HPE SmartMemory QuickSpecs at: <a href="https://www.hpe.com/h20195/v2/gethtml.aspx?docname=c04111535">https://www.hpe.com/h20195/v2/gethtml.aspx?docname=c04111535</a>					
	<b>NOTE:</b> LRDIMM and RDIMM are distinct memory technologies and cannot be mixed within a server.					
	<b>NOTE:</b> The maximum memory speed is a function of the memory type, memory configuration, and processor model. Please see Memory Population Table or the Online Memory Configuration Tool at: <a href="http://www.hpe.com/servers/servermemoryconfigurator">http://www.hpe.com/servers/servermemoryconfigurator</a>					
	<b>NOTE:</b> Memory DIMM availability with a server platform is dependent upon completion of certification testing.					
<b>Memory Protection</b>	For details on the HPE Server Memory Options RAS feature, visit: <a href="http://www.hpe.com/docs/memory-ras-feature">http://www.hpe.com/docs/memory-ras-feature</a> .					
<b>Expansion Slots (EE)</b>	Expansion Slot #	Technology	Bus Width*	Source	Connector Width	Form Factor
	1	PCIe 3.0	x16	CPU1	x16	Low profile
	Expansion Slot #	Technology	Bus Width*	Source	Connector Width	Form Factor
	FlexibleLOM	PCIe 3.0	x16	CPU1	x16	FlexibleLOM
	Expansion Slot #	Technology	Bus Width*	Source	Connector Width	Form Factor
	2	PCIe 3.0	x16	CPU1	x16	Low profile
	Expansion Slot	Technology	Bus Width*	Source	Connector Width	Form Factor
	2	PCIe 3.0	x16	CPU2	X16	Low profile
	<b>NOTE:</b> *Indicates the number of physical electrical lanes running to the connector.					
	<b>NOTE:</b> Expansion slot 1 requires ordering HPE XL1x0r Gen10 Left LP Riser Kit (874296-B21)					
	<b>NOTE:</b> FlexibleLOM require ordering HPE XL170r Gen10 FLOM Riser Kit (874298-B21)					
	<b>NOTE:</b> Expansion slot 2 requires ordering HPE XL170r Gen10 P1 LP Riser Kit (874300-B21) or HPE XL170r Gen10 P2 LP Riser Kit (874302-B21) or HPE XL170r 16NVMe Gen10 P2 LP Riser Kit (874304-B21)					

## Storage Controllers

## Standard Features

### Converged Network Adapters

HPE StoreFabric CN1200E 10Gb CNA  
 HPE StoreFabric CN1200E-T 10Gb CNA  
 HPE CN1100R 2P Converged Network Adapter  
 HPE StoreFabric CN1100R-T 10Gb CNA

### Smart Array Controller

HPE Smart Array E208i-p SR Gen10 Controller  
 HPE Smart Array E208e-p SR Gen10 Controller  
 HPE Smart Array P408e-p SR Gen10 Controller  
 HPE Smart Array P408i-p SR Gen10 Controller

### Host Bus Adapter

HPE SN1600Q 32Gb 1p FC HBA  
 HPE SN1600E 32Gb 1p FC HBA  
 HPE SN1600E 32Gb 2p FC HBA  
 HPE SN1200E 16Gb 2p FC HBA  
 HPE SN1100Q 16Gb 1p FC HBA

### Storage Controller Cable Kits

HPE 96W Smart Storage Battery 145mm Cbl  
 HPE XL170r Gen10 S100i SATA Cbl Kit  
 HPE XL170r Left E208ip/P408ip Cbl Kit  
 HPE XL170r Right E208ip/P408ip Cbl Kit

**NOTE:** AHCI mode is default settings and to convert to S100i mode, HPE FIO Enable Smart Array SW RAID needs to be selected.

Maximum Internal Storage	Capacity	Configuration
Hot Plug LFF SAS 7.2k	30TB	3 x 10TB
Hot Plug LFF SAS 15k	2.7TB	3 x 900GB
Hot Plug LFF SATA	30TB	3x 10TB
Hot Plug LFF SATA SSD	11.52TB	3x 3.84TB
Hot Plug LFF SAS SSD	4.8TB	3x 1.6TB
Hot Plug SFF SAS 7.2k	12TB	6x 2TB
Hot Plug SFF SAS 10k	14.4TB	6 x 2.4TB
Hot Plug SFF SAS 15k	5.4TB	6x 900GB
Hot Plug SFF SATA	12TB	6x 2TB
Hot Plug SFF SATA SSD	23.04TB	6x 3.84TB
Hot Plug SFF SAS SSD	23.04TB	6x 3.84TB
NVMe x4 MU SFF SCN DS SSD	8TB	2 x 4TB

### Internal Storage Devices

Internal MicroSD slot

### Interfaces

FlexibleLOM	HPE ProLiant Gen10 servers offer a new networking technology-Flexible Network Technology. The HPE ProLiant Gen10 server offers the customer the choice of 1Gigabit, 10Gigabit, 25Gigabit, InfiniBand or FlexibleLOM solutions depending on workload. For further details on the choices, see FlexibleLOM in the Networking Section of this document.
KVM	Serial USB Video Port (SUV)
MicroSD	1 (internal)
USB Ports	2 (external via SUV); 1 USB 3.0 (external);

## Standard Features

HPE iLO Remote Management Network Port	Aggregated via HPE Apollo 2000 Chassis; Option for dedicated NIC IM Board Kit
Health LED	1
Power	1
UID	1
Do not remove LED	1

## Operating Systems and Virtualization Software Support for ProLiant Servers

Windows Server 2012 R2 (Most Recent Version)  
Windows Server 2016 (Most Recent Version)  
VMware ESXi 6.0 U3  
VMware ESXi 6.5 and U1 upon release  
Red Hat Enterprise Linux (RHEL) 6.9, 7.3  
SUSE Linux Enterprise Server (SLES) 11 SP4, 12 SP2  
CentOS

**NOTE:** CentOS not directly supported / Community Supported (Based on RHEL so RHEL testing and enablement applicable to CentOS) CentOS 6.9 / CentOS 7.3

**NOTE:** For more information on Hewlett Packard Enterprise Certified and Supported ProLiant Servers for OS and Virtualization Software and latest listing of software drivers available for your server.

**<http://h20566.www2.hpe.com/portal/site/hpsc/public/psi/home?sp4ts.oid=1010026818>**

## Industry Standard Compliance

ACPI 6.1 Compliant  
PCIe 3.0 Compliant  
WOL Support  
Microsoft® Logo certifications  
PXE Support  
USB 3.0 Compliant (internal); USB 2.0 Compliant (external ports via SUV)  
SMBIOS 3.1  
UEFI 2.6  
Redfish API

## Power Specifications

To review typical system power ratings use the HPE Power Advisor which is available via the online tool located at URL: **<http://www.hpe.com/servers/powersupplies>**

**NOTE:** Power Specification and Technical Content for supported power supplies can be found at:

**<https://www.hpe.com/info/qs>**

## Graphics

Integrated Matrix G200 video standard

- 1280 x 1024 (32 bpp)
- 1920 x 1200 (16 bpp)
- HPE iLO 5 On System Management Memory
- 32 MB Flash
- 512 MB DDR 3 with ECC (112 MB after ECC and video)



## Standard Features

Part Number	Expansion Slot #	Technology	Bus Width*	Connector Width	Form Factor	Note
874296-B21	1	PCIe3.0	X16	X16	Low Profile	CPU1
Part Number	Expansion Slot #	Technology	Bus Width	Connector Width	Form Factor	Note
874298-B21	FlexibleLOM	PCIe3.0	X16	X16	FlexibleLOM	CPU1
Part Number	Expansion Slot #	Technology	Bus Width	Connector Width	Form Factor	Note
874300-B21	2	PCIe3.0	X16	X16	Low Profile	CPU1
Part Number	Expansion Slot #	Technology	Bus Width	Connector Width	Form Factor	Note
874302-B21	2	PCIe3.0	X16	X16	Low Profile	CPU2

### HPE Server UEFI /Legacy ROM

Unified Extensible Firmware Interface (UEFI) is an industry standard that provides better manageability and more secured configuration than the legacy ROM while interacting with your server at boot time. HPE ProLiant Gen10 servers have a UEFI Class 2 implementation and support both UEFI Mode (default) and Legacy BIOS Mode.

**NOTE:** The UEFI System Utilities tool is analogous to the HPE ROM-Based Setup Utility (RBSU) of legacy BIOS. For more information, please visit <http://www.hpe.com/servers/uefi>.

UEFI enables numerous new capabilities specific to HPE ProLiant servers such as:

- Secure Boot and Secure Start enable for enhanced security
- Operating system specific functionality
- Support for > 2.2 TB (using GPT) boot drives
- USB 3.0 Stack
- Embedded UEFI Shell
- Mass Configuration Deployment Tool using iLO RESTful API that is Redfish API Conformant
- PXE boot support for IPv6 networks
- Workload Profiles for simple performance optimization

UEFI Boot Mode only:

- TPM 2.0 Support
- NVMe Boot Support
- Platform Trust Technology (PTT) can be enabled.
- iSCSI Software Initiator Support.
- HTTP/HTTPs Boot support as a PXE alternative.
- Boot support for option cards that only support a UEFI option ROM

**NOTE:** For UEFI Boot Mode, boot environment and OS image installations should be configured properly to support UEFI.

**NOTE:** UEFI FIO Setting (758959-B22) can be selected to configure the system in Legacy mode in the factory for your HPE ProLiant XL170r Gen10 Server.

### Form Factor

The ProLiant XL170r Gen10 Server is a half width tray for the HPE Apollo 2000 Chassis

### Embedded Management

**HPE Integrated Lights-Out (HPE iLO)** Monitor your servers for ongoing management, service alerting, reporting and remote management with HPE iLO. Learn more at <http://www.hpe.com/info/ilo>

## Additional Options

<b>UEFI</b>	Configure and boot your servers securely with industry standard Unified Extensible Firmware Interface (UEFI). Learn more at <a href="http://www.hpe.com/servers/uefi">http://www.hpe.com/servers/uefi</a>
<b>iLO RESTful API</b>	iLO RESTful API is Redfish API conformance and offers simplified server management automation such as configuration and maintenance tasks based on modern industry standards. Learn more at <a href="http://www.hpe.com/info/restfulapi">http://www.hpe.com/info/restfulapi</a>
<b>Server Utilities</b>	
<b>Active Health System</b>	The HPE Active Health System (AHS) is an essential component of iLO management portfolio that provides continuous, proactive health monitoring of HPE servers. Learn more at <a href="http://www.hpe.com/servers/ahs">http://www.hpe.com/servers/ahs</a>
<b>Active Health System Viewer</b>	Use the Active Health System Viewer, a web-based portal, to easily read AHS logs and speed problem resolution with HPE self-repair recommendations. Learn more at <a href="http://www.hpe.com/servers/ahsv">http://www.hpe.com/servers/ahsv</a>
<b>Smart Update</b>	Keep your servers up to date with HPE's Smart Update solution by using Smart Update Manager (SUM) to optimize the firmware and driver updates of the Service Pack for ProLiant (SPP). <a href="http://www.hpe.com/info/smartupdate">http://www.hpe.com/info/smartupdate</a> .
<b>iLO Amplifier Pack</b>	Designed for large enterprise and service provider environments with hundreds of HPE servers, the iLO Amplifier Pack is a free, downloadable open virtual application (OVA) that delivers the power to discover, inventory and update Gen8, Gen9 and Gen10 HPE servers at unmatched speed and scale. Use with an iLO Advanced License to unlock full capabilities. <a href="http://www.hpe.com/servers/iLOamplifierpack">http://www.hpe.com/servers/iLOamplifierpack</a>
<b>HPE iLO Mobile Application</b>	Enables the ability to access, deploy, and manage your server anytime from anywhere from select smartphones and mobile devices. <a href="http://www.hpe.com/info/ilo/mobileapp">http://www.hpe.com/info/ilo/mobileapp</a>
<b>RESTful Interface Tool</b>	RESTful Interface tool (iLOREST) is a single scripting tool to provision using iLO RESTful API to discover and deploy servers at scale. <a href="http://www.hpe.com/info/resttool">http://www.hpe.com/info/resttool</a>
<b>Scripting tools</b>	Provision 1 to many servers using your own scripts to discover and deploy with Scripting Toolkit (STK) for Windows and Linux or Scripting Tools for Windows PowerShell. <a href="http://www.hpe.com/servers/stk">http://www.hpe.com/servers/stk</a> or <a href="http://www.hpe.com/servers/powershell">http://www.hpe.com/servers/powershell</a>
<b>HPE OneView Standard</b>	HPE OneView Standard can be used for inventory, health monitoring, alerting, and reporting without additional fees. It can monitor multiple HPE Servers generations. The user interface is similar to the HPE OneView Advanced version, but the software-defined functionality is not available. <a href="http://www.hpe.com/info/oneview">http://www.hpe.com/info/oneview</a>
<b>HPE Systems Insight Manager (HPE SIM)</b>	Ideal for environments already using HPE SIM, it allows you to monitor the health of your HPE ProLiant Servers and HPE Integrity Servers. Also provides you with basic support for non-HPE servers. HPE SIM also integrates with Smart Update Manager to provide quick and seamless firmware updates. <a href="http://www.hpe.com/info/hpesim">www.hpe.com/info/hpesim</a>
<b>Server Management Software Licenses</b>	
<b>HPE iLO Advanced</b>	HPE iLO Advanced licenses offer smart remote functionality without compromise, for all HPE ProLiant servers. The license includes the full integrated remote console, virtual keyboard, video, and mouse (KVM), multi-user collaboration, console record and replay, and GUI-based and scripted virtual media and virtual folders. You can also activate the enhanced security and power management functionality. <a href="http://www.hpe.com/servers/iloadvanced">http://www.hpe.com/servers/iloadvanced</a>
<b>HPE iLO Advanced Premium Security Edition</b>	HPE iLO Advanced Premium Security Edition for iLO 5 includes iLO Advanced License plus high-end security modes, unique security capabilities, like Automatic FW recovery; Runtime FW verification, and Secure erase. <a href="http://www.hpe.com/servers/ilopremium">http://www.hpe.com/servers/ilopremium</a>
<b>HPE iLO Scale-Out</b>	HPE iLO Scale-Out is the preferred license built for web hosting, cloud service providers, and high performance computing data centers, managing massive scale out environments. This license offers sophisticated scripting tools that provides remote access through Text Console

## Additional Options

- via SSH, Dynamic power capping, Email-based Alerting and proactive notifications. <http://www.hpe.com/servers/iLO/scale-out>
- HPE OneView Advanced** HPE OneView brings a new level of automation to infrastructure management by taking a template driven approach to provisioning, updating, and integrating compute, storage, and networking infrastructure. It provides full-featured licenses which can be purchased for managing Gen8 Gen9 and Gen10 servers. <http://www.hpe.com/info/oneview>
- HPE Insight Cluster Management Utility (CMU)** HPE Insight Cluster Management Utility (CMU) is an integrated, easy-to-use tool for provisioning, managing, and monitoring Linux® clusters of any scale. The utility's scale-out architecture supports clusters ranging from two to thousands of nodes. <http://www.hpe.com/info/cmu>
- HPE Performance Software—Message Passing Interface** The HPE Performance Software—Message Passing Interface (MPI) is an MPI development environment designed to enable the development and optimization of high performance computing (HPC) applications. The HPE Performance Software—MPI leverages a scalable MPI library and boosts performance of existing applications without requiring recompilation. <http://www.hpe.com/software/mpl>

- HPE iLO Standard (embedded in server)
- HPE iLO Advanced (requires license)
- HPE iLO Advanced Premium Security Edition (requires license)
- Intelligent Provisioning (embedded in server)
- HPE OneView Standard (requires download)
- HPE OneView Advanced (requires license)

For more information on Server Management – <http://www.hpe.com/info/servermanagement>

For more information on HPE iLO Licensing – <http://www.hpe.com/support/iLOLicenseGuide-en> For more information on HPE OneView – <http://www.hpe.com/info/hpeoneview>

### Security

- UEFI Secure Boot and Secure Start support
- Immutable Silicon Root of Trust
- Support for Commercial National Security Algorithms (CNSA)
- iLO Advanced Premium Security Edition
- Granular control over iLO interfaces
- Common Access Card (CAC) 2-factor Authentication
- Tamper-free updates – components digitally signed and verified
- Secure Recovery – recover critical firmware to known good state on detection of compromised firmware
- TPM (Trusted Platform Module) 1.2 option
- TPM (Trusted Platform Module) 2.0 option Bezel Locking Kit
- Intrusion Security Kit option
- Runtime Firmware Validation – Periodically scan essential firmware for compromised code during runtime

### Ethernet Options

- HPE Ethernet 10/25Gb 2p 631FLR-SFP28 Adapter
- HPE Flexfabric 10Gb 4P 536FLR-T Adapter
- HPE Ethernet 10Gb 2P 530SFP+ Adapter
- HPE FlexFabric 10Gb 2P 534FLR-SFP+ Adapter
- HPE Ethernet 10/25Gb 2p 631SFP28 Adapter
- HPE Ethernet 10Gb 2p 535T Adapter
- HPE Ethernet 10Gb 2p 535FLR-T Adapter
- HPE Ethernet 1Gb 4P 331FLR Adapter
- HPE FlexFabric 10Gb 2P 533FLR-T Adapter
- HPE Ethernet 10/25Gb 2-port 661SFP28 Adapter

## Additional Options

- HPE Ethernet 10Gb 2p 562T Adapter
- HPE Ethernet 10Gb 2p 562FLR-T Adapter
- HPE Ethernet 1Gb 4-port 366FLR Adapter
- HPE Ethernet 1Gb 4-port 366T Adapter
- HPE Ethernet 1Gb 2P 368FLR-MMT Adapter
- HPE Ethernet 10Gb 2p 568FLR-MMSFP+ Adapter
- HPE Ethernet 10/25Gb 2P 640FLR-SFP28 Adapter
- HPE Ethernet 10/25Gb 2P 640SFP28 Adapter
- HPE Ethernet 1Gb 4-port 331T Adapter
- HPE Ethernet 10/25Gb 2p 621SFP28 Adapter
- HPE Ethernet 10Gb 2p 522FLR-T CNA
- HPE Ethernet 4x25Gb 1p 620QSFP28 Adapter
- HPE Ethernet 10/25Gb 2p 622FLR-SFP28 CAN
- HPE Ethernet 10Gb 2p 521T Adapter
- HPE XL1x0r Ethernet 10Gb 2p 568FLR-MMT Adapter
- HPE Ethernet 10Gb 2P 530T Adapter
- HPE Ethernet 1Gb 2P 332T Adapter

### InfiniBand Options

- HPE IB EDR 100Gb 1P 841QSFP28 Adapter
- HPE IB EDR/EN 100Gb 1P 840QSFP28 Adapter
- HPE IB EDR/EN 100Gb 2P 840QSFP28 Adapter
- HPE 100Gb 1p OP101 QSFP28 x16 OPA Adapter
- HPE 100Gb 1p OP101 QSFP28 x8 OPA Adapter
- HPE XL1x0r Gen10 Fab-CPU Enbl Adptr Kit

### PE Pointnext Service and Support

**The support of HPE XL170r tray covers the tray and all included options. It is recommended to have the same attached support level for the Server tray as the chassis**

#### HPE Technology Services for Apollo Systems

##### Protect your business beyond warranty with HPE Support Services

HPE Pointnext provides a comprehensive portfolio including Advisory and Transformational, Professional, and Operational Services to help accelerate your digital transformation. From the onset of your transformation journey, Advisory and Transformational Services focus on designing the transformation and creating a solution roadmap. Professional Services specializes in creative configurations with flawless and on-time implementation, and on-budget execution. Finally, operational services provides innovative new approaches like Flexible Capacity and Datacenter Care, to keep your business at peak performance. HPE is ready to bring together all the pieces of the puzzle for you, with an eye on the future, and make the complex simple.

##### Get connected to Hewlett Packard Enterprise to improve your support experience

###### Connect your devices:

Unlock all of the benefits of your technology investment by connecting your products to Hewlett Packard Enterprise. Reduce down time and improve diagnostic accuracy with a single consolidated view of your environment. By connecting, you will receive 24x7 monitoring, pre-failure alerts, automatic call logging, and automatic parts dispatch. HPE Proactive Care Service and HPE Datacenter Care Service customers will also benefit from proactive activities to help prevent issues and increase optimization. All of these benefits are already available to you with your server storage and networking products, securely connected to HPE support. Learn more about getting connected at <http://www.hpe.com/services/getconnected>

HPE Proactive Care gives customers an enhanced call experience. When your products are connected to HPE, Proactive Care helps prevent problems and maintains IT stability by utilizing personalized proactive reports with recommendations and advice. This Service combines three years proactive reporting and advice with our 24x7 coverage, four hour hardware response time when there is a problem. This service also includes collaborative software support for Independent Software Vendors (ISVs), (Red Hat, VMWare, Microsoft, etc.) running on your HPE servers. <https://www.hpe.com/h20195/v2/GetPDF.aspx/4AA3-8855ENW.pdf>

## Service and Support

**NOTE:** \*HPE Proactive Care and HPE Proactive Care Advanced require that the customer connect their devices to make the most of these services and receive all the deliverables.

### **Standard recommendation: HPE Foundation Care 24x7, three-year Support Service**

HPE Foundation Care 24x7 gives you access to HPE 24 hours a day, seven days a week for assistance on resolving issues. This service includes need based Hardware onsite response within four hours. In addition, collaborative software support is included in this service that provides troubleshooting assistance on industry leading software running on your HPE server. Simplify your support experience and make HPE your first call to help resolve hardware or software problems.

<https://www.hpe.com/h20195/V2/GetDocument.aspx?docname=4AA4-8876ENW&cc=us&lc=en>

### **Basic recommendation: HPE Foundation Care NBD, three-year Support Service**

HPE Foundation Care Next Business Day connects you to HPE during business hours for assistance on resolving issues – This service features need based next business day hardware onsite response and software call back within two hours. In addition, Collaborative software support and provides troubleshooting assistance on industry leading software running on your HPE server. Simplify your support experience and make HPE your first call to help resolve hardware or software problems. <https://www.hpe.com/h20195/V2/GetDocument.aspx?docname=4AA4-8876ENW&cc=us&lc=en>

### **Parts and Materials**

HPE will provide HPE-supported replacement parts and materials necessary to maintain the covered hardware product in operating condition, including parts and materials for available and recommended engineering improvements.

Parts and components that have reached their maximum supported lifetime and/or the maximum usage limitations as set forth in the manufacturer's operating manual, product quick-specs, or the technical product data sheet will not be provided, repaired, or replaced as part of these services.

The defective media retention service feature option applies only to Disk or eligible SSD/Flash Drives replaced by HPE due to malfunction.

### **Other Related Services**

#### **HPE Server Hardware Installation**

Provides for the basic hardware installation of HPE branded servers, storage devices and networking options to assist you in bringing your new hardware into operation in a timely and professional manner.

<https://www.hpe.com/h20195/V2/GetPDF.aspx/5981-9356EN.pdf>

#### **HPE Installation and Startup Service**

Provides for the installation of your HPE hardware according to product specifications including options as well as installation of the operating system. The HPE service delivery technician will connect the product to a LAN as appropriate and enable remote support to allow for automatic case creation for hardware failures.

#### **HPE Datacenter Care service**

HPE Datacenter Care helps improve IT stability and security, increase the value of IT, and enable agility and innovation. It is a structured framework of repeatable, tested, and globally available services “building blocks.” You can deploy, operate, and evolve your datacenter wherever you are on your IT journey. With HPE Datacenter Care, you benefit from a personalized relationship with HPE via a single point of accountability for HPE and others' products. For more information,

visit <http://www.hpe.com/services/datacentercare>

#### **HPE Flexible Capacity**

With Flexible Capacity, you get the speed, scalability, and economics of the public cloud in the privacy of your data center. Gain the advantages of the public cloud—consumption-based payment, rapid scalability without worrying about capacity constraints. Reduce the “heavy lifting” needed to operate a data center. And retain the advantages that IT provides the business (i.e., control, security). Deliver the right user experience, choose the right technology for the business, manage privacy and compliance, and manage the cost of IT. And, you have the option to use the public cloud when needed.

#### **DC for Hyperscale**

Datacenter Care for Hyperscale is available for Service Providers and HPC customers who use a scale out approach to computing with a high volume homogenous infrastructure and resilient architecture can take advantage of this environment support tailored to their operating model.

## Service and Support

### HPE Factory Express for Servers and storage

HPE Factory Express offers configuration, customization, integration and deployment services for HPE servers and storage products. Customers can choose how their factory solutions are built, tested, integrated, shipped and deployed.

Factory Express offers service packages for simple configuration, racking, installation, complex configuration and design services as well as individual factory services, such as image loading, asset tagging, and custom packaging. HPE products supported through Factory Express include a wide array of servers and storage: HPE Integrity, HPE ProLiant, HPE Apollo, HPE ProLiant Server Blades, HPE BladeSystem, HPE 9000 servers, as well as the HPE MSAXxxx, HPE 3PAR suite, HPE XP, rackable tape libraries and configurable network switches.

### HPE Technology Services Support Credits

Offer flexible services and technical skills to meet your changing IT demands. With a menu of service that is tailored to suit your needs, you get additional resources and specialist skills to help you maintain peak performance of your IT. Offered as annual credits, you can plan your budgets while proactively responding to your dynamic business.

### HPE Education Services

Keep your IT staff trained making sure they have the right skills to deliver on your business outcomes. Book a class today and learn how to get the most from your technology investment. <http://www.hpe.com/ww/learn>

### HPE Support Center

The HPE Support Center is a personalized online support portal with access to information, tools and experts to support HPE business products. Submit support cases online, chat with HPE experts, access support resources or collaborate with peers. Learn more at <http://www.hpe.com/support/hpesc>

HPE's Support Center Mobile App\* allows you to resolve issues yourself or quickly connect to an agent for live support. Now, you can get access to personalize IT support anywhere, anytime. HPE Insight Remote Support and HPE Support Center are available at no additional cost with a HPE warranty, HPE Support Service or HPE contractual support agreement.

**NOTE:** \*HPE Support Center Mobile App is subject to local availability

For more information visit <http://www.hpe.com/services>

## Configuration Information – Factory Integrated Models

**NOTE:** This section lists some of the steps required to configure a Factory Integrated Model. To ensure only valid configurations are ordered, Hewlett Packard Enterprise recommends the use of a Hewlett Packard Enterprise approved configurator. Contact your local sales representative for information on configurable product offerings and requirements.

**NOTE:** FIO indicates that this option is only available as a factory installable option.

**NOTE:** The HPE Apollo 2000 Chassis is required to support the server. Refer to HPE Apollo 2000 Chassis QuickSpecs for additional information.

### Step 1: Base Configuration (Choose one of the CTO Models below)

**HPE CTO Model** HPE ProLiant XL170r Gen10 1U Node Configure-to-order Server 867055-B21

### Step 2: Choose Required Options (only one from each category unless otherwise noted)

#### Intel-Platinum Processors

HPE XL1x0r Gen10 Intel Xeon-Platinum 8164 (2.0GHz/26-core/150W) FIO Processor Kit	874295-L21
HPE XL1x0r Gen10 Intel Xeon-Platinum 8160 (2.1GHz/24-core/145W) FIO Processor Kit	874294-L21
HPE XL1x0r Gen10 Intel Xeon-Platinum 8158 (3.0GHz/12-core/150W) FIO Processor Kit	879567-L21
HPE XL1x0r Gen10 Intel Xeon-Platinum 8156 (3.6GHz/4-core/150W) FIO Processor Kit	879569-L21
HPE XL1x0r Gen10 Intel Xeon-Platinum 8153 (2.0GHz/16-core/125W) FIO Processor Kit	879571-L21

#### Intel-Gold Processors

HPE XL1x0r Gen10 Intel Xeon-Gold 6152 (2.1GHz/22-core/140W) FIO Processor Kit	874293-L21
HPE XL1x0r Gen10 Intel Xeon-Gold 6148 (2.4GHz/20-core/145W) FIO Processor Kit	874292-L21
HPE XL1x0r Gen10 Intel Xeon-Gold 6142 (2.6GHz/16-core/150W) FIO Processor Kit	874287-L21
HPE XL1x0r Gen10 Intel Xeon-Gold 6140 (2.3GHz/20-core/135W) FIO Processor Kit	874289-L21
HPE XL1x0r Gen10 Intel Xeon-Gold 6138 (2.0GHz/20-core/125W) FIO Processor Kit	874291-L21
HPE XL1x0r Gen10 Intel Xeon-Gold 6136 (3.0GHz/12-core/150W) FIO Processor Kit	874288-L21
HPE XL1x0r Gen10 Intel Xeon-Gold 6134 (3.2GHz/8-core/130W) FIO Processor Kit	874290-L21
HPE XL1x0r Gen10 Intel Xeon-Gold 6132 (2.6GHz/14-core/140W) FIO Processor Kit	880669-L21
HPE XL1x0r Gen10 Intel Xeon-Gold 6130 (2.1GHz/16-core/120W) FIO Processor Kit	874286-L21
HPE XL1x0r Gen10 Intel Xeon-Gold 6128 (3.4GHz/6-core/115W) FIO Processor Kit	880667-L21
HPE XL1x0r Gen10 Intel Xeon-Gold 6126 (2.6GHz/12-core/125W) FIO Processor Kit	874283-L21
HPE XL1x0r Gen10 Intel Xeon-Gold 5122 (3.6GHz/4-core/105W) FIO Processor Kit	874282-L21
HPE XL1x0r Gen10 Intel Xeon-Gold 5120 (2.2GHz/14-core/105W) FIO Processor Kit	879583-L21
HPE XL1x0r Gen10 Intel Xeon-Gold 5118 (2.3GHz/12-core/105W) FIO Processor Kit	879581-L21
HPE XL1x0r Gen10 Intel Xeon-Gold 5115 (2.4GHz/10-core/85W) FIO Processor Kit	879579-L21

#### Intel-Silver Processors

HPE XL1x0r Gen10 Intel Xeon-Silver 4116 (2.1GHz/12-core/85W) FIO Processor Kit	879577-L21
HPE XL1x0r Gen10 Intel Xeon-Silver 4114 (2.2GHz/10-core/85W) FIO Processor Kit	879599-L21
HPE XL1x0r Gen10 Intel Xeon-Silver 4112 (2.6GHz/4-core/85W) FIO Processor Kit	879597-L21
HPE XL1x0r Gen10 Intel Xeon-Silver 4110 (2.6GHz/8-core/85W) FIO Processor Kit	879595-L21
HPE XL1x0r Gen10 Intel Xeon-Silver 4108 (2.1GHz/8-core/85W) FIO Processor Kit	879591-L21
HPE XL1x0r Gen10 Intel Xeon-Silver 4109T (2.0GHz/8-core/70W) FIO Processor Kit	879593-L21

#### Intel-Bronze Processors

HPE XL1x0r Gen10 Intel Xeon-Bronze 3106 (1.8GHz/8-core/85W) FIO Processor Kit	879589-L21
HPE XL1x0r Gen10 Intel Xeon-Bronze 3104 (1.7GHz/6-core/85W) FIO Processor Kit	879587-L21

**NOTE:** Must select one xxxxxx-L21 processor. If one processor is desired, select one xxxxxx-L21. If two processors are desired, select one corresponding xxxxxx-B21. Mixing of processor speeds and types is not supported.

**NOTE:** DDR4 speed is the maximum memory speed of the processor. Actual memory speed may depend on the quantity and type of DIMMs installed. For the maximum supported memory speeds for each processor listed above, please reference the 'Memory Speed by Processor Model' table in the Memory section of the QuickSpecs.

### HPE Memory

## Configuration Information – Factory Integrated Models

**NOTE:** Depending on the memory configuration and processor model, the memory speed may run at 2666MHz, 2400MHz, and 2133MHz. Please see Memory Population Table or the Online Memory Configuration Tool at: <http://h22195.www2.hpe.com/MemoryTool/Home/Legal>

### Registered DIMMs (RDIMMs) – DDR4-2666

HPE 8GB (1x8GB) Single Rank x8 DDR4-2666 CAS-19-19-19 Registered Smart Memory Kit	815097-B21
HPE 16GB (1x16GB) Single Rank x4 DDR4-2666 CAS-19-19-19 Registered Smart Memory Kit	815098-B21
HPE 32GB (1x32GB) Dual Rank x4 DDR4-2666 CAS-19-19-19 Registered Smart Memory Kit	815100-B21
HPE 16GB (1x16GB) Dual Rank x8 DDR4-2666 CAS-19-19-19 Registered Smart Memory Kit	835955-B21
HPE 8GB (1x8GB) Dual Rank x8 DDR4-2666 CAS-19-19-19 Registered Smart Memory Kit	876181-B21

### Load Reduced DIMMs (LRDIMMs) – DDR4-2666

HPE 64GB (1x64GB) Quad Rank x4 DDR4-2666 CAS-19-19-19 Load Reduced Smart Memory Kit	815101-B21
---	------------

**NOTE:** Minimum 2 DIMMs are required per server; up to 8 DIMMs per processor.

**NOTE:** If Fabric CPU is installed, minimum of 32GB is required

**NOTE:** A maximum of 16 DIMMs are supported per XL170r server tray (or 8 DIMMs max per processor).

**NOTE:** LRDIMM and RDIMM are distinct memory technologies and cannot be mixed within a server.

**NOTE:** HPE memory from previous generation servers is not compatible with this server. HPE SmartMemory is required to realize the memory performance improvements and enhanced functionality listed in this document for Gen10. For additional information, please see the HPE SmartMemory QuickSpecs

at: <https://www.hpe.com/h20195/v2/GetPDF.aspx/c04355083.pdf>

### HPE PCIe riser kits

HPE XL170r Gen10 Right Riser Blank FIO Kit	874802-B21
HPE XL1x0r Gen10 Left Riser Blank FIO Kit	874805-B21
HPE XL1x0r Gen10 Left Low Profile Riser Kit	874296-B21
HPE XL170r Gen10 FlexibleLOM Riser Kit	874298-B21
HPE XL170r Gen10 P1 Low Profile Riser Kit	874300-B21
HPE XL170r Gen10 P2 Low Profile Riser Kit	874302-B21
HPE XL1x0r Gen10 M2 (NGFF) Riser Kit	874853-B21
HPE XL170r Gen10 16NVMe P2 Low Profile Riser Kit	874304-B21

### HPE Storage Cables

HPE 96W Smart Storage Battery (up to 20 Devices/145mm Cable) Kit	875241-B21
--	------------

**NOTE:** The battery cable kit needs to be selected if the node has the P series controller in the node configuration

HPE XL170r Gen10 S100i SATA Cable Kit	874305-B21
---------------------------------------	------------

**NOTE:** Required to be selected when S100i is the primary controller; supports to connect to SATA drives; select 1cable kit per node

**NOTE:** R2200 + 1U node – supports max of 3 SATA hard drive per node; R2600 + 1U node – supports 6 SATA hard drives per node

HPE XL170r Left E208ip/P408ip Cable Kit	874785-B21
---	------------

**NOTE:** Required to be selected when E208i or P408i is selected in the configuration along with HPE XL1x0r Gen10 Left LP Riser Kit excluding Fabric CPU enablement kit in the configuration

HPE XL170r Right E208ip/P408ip Cable Kit	874855-B21
--	------------

**NOTE:** Required to be selected when E208i or 408i is selected along with one the below mentioned Riser including the Fabric CPU enablement kit in the configuration:



## Configuration Information – Factory Integrated Models

HPE XL170r Gen10 FLOM Riser Kit, HPE XL170r Gen10 P2 LP Riser Kit, HPE XL170r 16NVM3 Gen10 P2 LP Riser Kit

### Step 3: Choose Additional Factory Integrated Options (only one from each category unless otherwise noted)

<b>BIOS Mode</b>	HPE Legacy FIO Mode Setting	758959-B22
	<b>NOTE:</b> The system BIOS provides two different Boot Modes: UEFI (Standard) and Legacy BIOS (optional) (758959-B22) When this option is selected, then BIOS need to be switched from default UEFI Mode to Legacy Mode	
<b>Controller State</b>	HP Manufacturing FIO Enable HBA Mode Setting	792962-B21
	<b>NOTE:</b> If E208i is the primary controller and if HPE Mfg FIO Enable HBA Mode Setting is selected, then RAID is not allowed – can only be selected with E208i only	
<b>RAID</b>	HP RAID 0 Drive 1 FIO Setting	339777-B21
	HP RAID 1 Drive 1 FIO Setting	339778-B21
	HP RAID 5 Drive 1 FIO Setting	339779-B21
	HP Raid 5 w/SP Drive 1 FIO Setting	339780-B21
	HP RAID FIO Advanced Data Guarding Option	339781-B21
	HP Customer Defined RAID Setting Service	389692-B21
<b>TPM FIO</b>	HP RAID 0 Drive 1 FIO Setting ALL	
	HP RAID 0 Drive 1 FIO Setting	339777-B21
	HP RAID 1 Drive 1 FIO Setting	339778-B21
	HP RAID 5 Drive 1 FIO Setting	339779-B21
	HP Raid 5 w/SP Drive 1 FIO Setting	339780-B21
	HP RAID FIO Advanced Data Guarding Option	339781-B21
	HPE Gen10 TPM 1.2 FIO Setting	872108-B21
	<b>NOTE:</b> this can be selected only when TPM 2.0 is selected in the configuration	

### Step 4: Choose Additional Options for Factory Integration from Core and Additional Options sections below

**NOTE:** Some options may not be integrated at the factory. To ensure only valid configurations are ordered, Hewlett Packard Enterprise recommends the use of a Hewlett Packard Enterprise approved configurator. Contact your local sales representative for additional information.

#### Intel-Platinum Processors

HPE XL1x0r Gen10 Intel® Xeon-Platinum 8164 (2.0GHz/26-core/150W) Processor Kit	874295-B21
HPE XL1x0r Gen10 Intel® Xeon-Platinum 8160 (2.1GHz/24-core/150W) Processor Kit	874294-B21
HPE XL1x0r Gen10 Intel® Xeon-Platinum 8158 (3.0GHz/12-core/150W) Processor Kit	879567-B21
HPE XL1x0r Gen10 Intel® Xeon-Platinum 8156 (3.6GHz/4-core/105W) Processor Kit	879569-B21
HPE XL1x0r Gen10 Intel® Xeon-Platinum 8153 (2.0GHz/16-core/125W) Processor Kit	879571-B21

#### Intel-Gold Processors

HPE XL1x0r Gen10 Intel® Xeon-Gold 6152 (2.1GHz/22-core/140W) Processor Kit	874293-B21
HPE XL1x0r Gen10 Intel® Xeon-Gold 6148 (2.4GHz/20-core/150W) Processor Kit	874292-B21
HPE XL1x0r Gen10 Intel® Xeon-Gold 6142 (2.6GHz/16-core/150W) Processor Kit	874287-B21
HPE XL1x0r Gen10 Intel® Xeon-Gold 6140 (2.3GHz/18-core/140W) Processor Kit	874289-B21

## Configuration Information – Factory Integrated Models

HPE XL1x0r Gen10 Intel® Xeon-Gold 6138 (2.0 GHz/20-core/125W) Processor Kit	874291-B21
HPE XL1x0r Gen10 Intel® Xeon-Gold 6138 Fabric (2.0GHz/20-core/135W) Processor Kit	880670-B21
HPE XL1x0r Gen10 Intel® Xeon-Gold 6136 (3.0GHz/12-core/150W) Processor Kit	874288-B21
HPE XL1x0r Gen10 Intel® Xeon-Gold 6134 (3.2GHz/8-core/130W) Processor Kit	874290-B21
HPE XL1x0r Gen10 Intel® Xeon-Gold 6132 (2.6GHz/14-core/140W) Processor Kit	880669-B21
HPE XL1x0r Gen10 Intel® Xeon-Gold 6130 (2.1GHz/16-core/125W) Processor Kit	874286-B21
HPE XL1x0r Gen10 Intel® Xeon-Gold 6130 Fabric (2.1GHz/16-core/135W) Processor Kit	880668-B21
HPE XL1x0r Gen10 Intel® Xeon-Gold 6128 (3.4GHz/6-core/115W) Processor Kit	880667-B21
HPE XL1x0r Gen10 Intel® Xeon-Gold 6126 (2.6GHz/12-core/125W) Processor Kit	874283-B21
HPE XL1x0r Gen10 Intel® Xeon-Gold 6126 Fabric (2.6GHz/12-core/135W) Processor Kit	880666-B21
HPE XL1x0r Gen10 Intel® Xeon-Gold 5122 (3.6GHz/4-core/105W) Processor Kit	874282-B21
HPE XL1x0r Gen10 Intel® Xeon-Gold 5120 (2.2GHz/14-core/105W) Processor Kit	879583-B21
HPE XL1x0r Gen10 Intel® Xeon-Gold 5118 (2.3GHz/12-core/105W) Processor Kit	879581-B21
<b>HPE XL1x0r Gen10 Intel® Xeon-Gold 6148 (2.4GHz/20-core/150W) Processor Kit</b>	874292-B21
HPE XL1x0r Gen10 Intel® Xeon-Silver 4116 (2.1GHz/12-core/85W) Processor Kit	879577-B21
HPE XL1x0r Gen10 Intel® Xeon-Silver 4114 (2.2GHz/10-core/85W) Processor Kit	879599-B21
HPE XL1x0r Gen10 Intel® Xeon-Silver 4112 (2.6GHz/4-core/85W) Processor Kit	879597-B21
HPE XL1x0r Gen10 Intel® Xeon-Silver 4110 (2.1GHz/8-core/85W) Processor Kit	879595-B21
HPE XL1x0r Gen10 Intel® Xeon-Silver 4108 (1.8GHz/8-core/85W) Processor Kit	879591-B21
HPE XL1x0r Gen10 Intel® Xeon-Silver 4109T (2.0GHz/8-core/70W) Processor Kit	879593-B21
<b>HPE XL1x0r Gen10 Intel® Xeon-Silver 4116 (2.1GHz/12-core/85W) Processor Kit</b>	879577-B21
HPE XL1x0r Gen10 Intel® Xeon-Bronze 3106 (1.7GHz/8-core/85W) Processor Kit	879589-B21
HPE XL1x0r Gen10 Intel® Xeon-Bronze 3104 (1.7GHz/6-core/85W) Processor Kit	879587-B21

**NOTE:** DDR4 speed is the maximum memory speed of the processor. Actual memory speed may depend on the quantity and type of DIMMs installed. For the maximum supported memory speeds for each processor listed above, please reference the 'Memory Speed by Processor Model' table in the Memory section of the QuickSpecs.

### HPE Memory

#### Registered DIMMs (RDIMMs) – DDR4-2666

HPE 8GB (1x8GB) Single Rank x8 DDR4-2666 CAS-19-19-19 Registered Smart Memory Kit	815097-B21
HPE 16GB (1x16GB) Single Rank x4 DDR4-2666 CAS-19-19-19 Registered Smart Memory Kit	815098-B21
HPE 32GB (1x32GB) Dual Rank x4 DDR4-2666 CAS-19-19-19 Registered Smart Memory Kit	815100-B21
HPE 16GB (1x16GB) Dual Rank x8 DDR4-2666 CAS-19-19-19 Registered Smart Memory Kit	835955-B21
HPE 8GB (1x8GB) Dual Rank x8 DDR4-2666 CAS-19-19-19 Registered Smart Memory Kit	876181-B21

#### Load Reduced DIMMs (LRDIMMs) – DDR4-2666

HPE 64GB (1x64GB) Quad Rank x4 DDR4-2666 CAS-19-19-19 Load Reduced Smart Memory Kit	815101-B21
---	------------

**NOTE:** HPE memory from previous generation servers (DDR3) is not compatible with this server. HPE DDR4 SmartMemory is required to realize the memory performance improvements and enhanced

## Configuration Information – Factory Integrated Models

functionality listed in this document for Gen10. For additional information, please see the HPE DDR4 SmartMemory QuickSpecs at:

<http://www8.hpe.com/h20195/v2/GetHTML.aspx?docname=c04380279>

**NOTE:** LRDIMM and RDIMM are distinct memory technologies and cannot be miTPMxed within a server.

**NOTE:** Depending on the memory configuration and processor model, the memory speed may run at 2666MHz, 2400MHz, 2133MHz. Please see Memory Population Table or the Online Memory Configuration Tool at: <http://h22195.www2.hpe.com/MemoryTool/Home/Legal>

### HPE Networking

#### Ethernet Options

HPE Ethernet 10Gb 2-port 530SFP Adapter	652503-B21
HPE Ethernet 10/25Gb 2-port 631SFP28 Adapter	817718-B21
HPE Ethernet 10Gb 2-port 535T Adapter	813661-B21
HPE Ethernet 10Gb 2-port 562T Adapter	817738-B21
HPE Ethernet 1Gb 4-port 366T Adapter	811546-B21
HPE Ethernet 1Gb 2-port 368FLR-T Media Module Adapter	866464-B21
HPE Ethernet 10Gb 2-port 568FLR-SFP+ Media Module Adapter	866467-B21
HPE Ethernet 10/25Gb 2-port 640FLR-SFP28 Adapter	817749-B21
HPE Ethernet 10/25Gb 2-port 640SFP28 Adapter	817753-B21
HPE Ethernet 1Gb 4-port 331T Adapter	647594-B21
HPE Ethernet 10/25Gb 2-port 621SFP28 Adapter	867328-B21
HPE Ethernet 10Gb 2-port 521T Adapter	867707-B21
HPE XL1x0r Ethernet 10Gb 2-port 568FLR-MMT Adapter	868227-B21
HPE Ethernet 10Gb 2-port 530T Adapter	656596-B21
HPE Ethernet 1Gb 2-port 332T Adapter	615732-B21

**NOTE:** For 1U, total Slots available for PCIe is 2, total Slots available for FlexLOM is 1. This is a total selection from anything in the following categories: InfiniBand, Networking, Controllers.

#### FlexibleLOM Adapters

HPE Ethernet 1Gb 4-port 331FLR Adapter	629135-B22
HPE Ethernet 10/25Gb 2p 631FLR-SFP28 Adapter	817709-B21
HPE Ethernet 10Gb 2p 535FLR-T Adapter	817721-B21
HPE Ethernet 10Gb 2p 562FLR-T Adapter	817745-B21
HPE Ethernet 10Gb 2p 522FLR-T CNA	867331-B21
HPE Ethernet 10/25Gb 2p 622FLR-SFP28 CNA	867334-B21
HPE Ethernet 1Gb 4-port 366FLR Adapter	665240-B21
HPE Ethernet 4x25Gb 1-port 620QSFP28 Adapter	817762-B21
HPE FlexFabric 10Gb 2-port 534FLR-SFP+ Adapter	700751-B21
HPE FlexFabric 10Gb 2-port 533FLR-T Adapter	700759-B21
HPE FlexFabric 10Gb 4-port 536FLR-T Adapter	764302-B21

#### Converged Network Adapters

HPE StoreFabric CN1200E 10GBASE-T Dual Port Converged Network Adapter	N3U51A
HPE StoreFabric CN1100R 10GBASE-T Dual Port Converged Network Adapter	N3U52A
HPE StoreFabric CN1100R Dual Port Converged Network Adapter	QW990A
HPE StoreFabric CN1200E 10Gb Converged Network Adapter	E7Y06A

#### InfiniBand and Omni-Path Options

HPE InfiniBand EDR/Ethernet 100Gb 1-port 840QSFP28 Adapter	825110-B21
HPE InfiniBand EDR/Ethernet 100Gb 2-port 840QSFP28 Adapter	825111-B21

## Configuration Information – Factory Integrated Models

	HPE InfiniBand EDR 100Gb 1-port 841QSFP28 Adapter	872725-B21
	HPE 100Gb 1-port OP101 QSFP28 x16 PCIe Gen3 with Intel® Omni-Path Architecture Adapter	829335-B21
	HPE 100Gb 1-port OP101 QSFP28 x8 PCIe Gen3 with Intel® Omni-Path Architecture Adapter	829334-B21
	HPE XL1x0r Gen10 Fabric CPU Enablement Adapter Kit	874795-B21
	<b>NOTE: Please see the QuickSpecs for Technical Specifications and additional information: <a href="https://www.hpe.com/us/en/product-catalog/servers/server-adapters.hits-12.html">https://www.hpe.com/us/en/product-catalog/servers/server-adapters.hits-12.html</a></b>	
<b>M.2</b>	HPE 150GB SATA 6G Read Intensive M.2 2280 3yr Wty Digitally Signed Firmware SSD	875317-B21
	HPE 480GB SATA 6G Read Intensive M.2 2280 3yr Wty Digitally Signed Firmware SSD	875319-B21
	HPE 1.92GB SATA 6G Read Intensive M.2 2280 3yr Wty Digitally Signed Firmware SSD	875496-B21
	HPE 240GB SATA 6G Mixed Use M.2 2280 3yr Wty Digitally Signed Firmware SSD	875488-B21
	HPE 480GB SATA 6G Mixed Use M.2 2280 3yr Wty Digitally Signed Firmware SSD	875490-B21
	HPE 960GB SATA 6G Mixed Use M.2 2280 3yr Wty Digitally Signed Firmware SSD	875492-B21
	HPE 1.92TB SATA 6G Mixed Use M.2 2280 3yr Wty Digitally Signed Firmware SSD	875494-B21
	HPE 480GB SATA 6G Read Intensive M.2 2280 3yr Wty Digitally Signed Firmware SSD	875498-B21
	HPE 960GB SATA 6G Read Intensive M.2 2280 3yr Wty Digitally Signed Firmware SSD	875500-B21
<b>HPE Tape Backup</b>	<b>NOTE: For the complete range of tape drives, autoloaders, libraries and media see: <a href="http://www.hpe.com/storage/storeever">http://www.hpe.com/storage/storeever</a>. For hardware and software compatibility of Hewlett Packard Enterprise tape backup products <a href="http://www.hpe.com/storage/BURACompatibility">http://www.hpe.com/storage/BURACompatibility</a></b>	
	HPE StoreEver LTO-7 Ultrium 15000 External Tape Drive	BB874A
	HPE StoreEver LTO-6 Ultrium 6250 External Tape Drive	EH970A
	HPE StoreEver LTO-5 Ultrium 3000 SAS External Tape Drive	EH958B
	HPE StoreEver 1U SAS Rack Mount Kit	AE459B
	HPE StoreEver MSL6480 Scalable Base Module	QU625A
	HPE StoreEver MSL2024 0-drive Tape Library	AK379A
	HPE StoreEver MSL4048 0-drive Tape Library	AK381A
	HPE StoreEver 1/8 G2 LTO-7 Ultrium 15000 SAS Tape Autoloader	N7P35A
	HPE StoreEver 1/8 G2 LTO-7 Ultrium 15000 FC Tape Autoloader	N7P34A
	HPE StoreEver 1/8 G2 LTO-6 Ultrium 6250 SAS Tape Autoloader	COH18A
	HPE StoreEver 1/8 G2 LTO-6 Ultrium 6250 Fibre Channel Tape Autoloader	COH19A
	HPE StoreEver 1/8 G2 LTO-5 Ultrium 3000 SAS Tape Autoloader	BL536B
	HPE StoreEver 1/8 G2 LTO-5 Ultrium 3000 Fibre Channel Tape Autoloader	BL541B
	HPE StoreEver MSL LTO-7 Ultrium 15000 SAS Drive Upgrade Kit	N7P37A
	HPE StoreEver MSL LTO-7 Ultrium 15000 FC Drive Upgrade Kit	N7P36A
	HPE StoreEver MSL LTO-6 Ultrium 6250 SAS Drive Upgrade Kit	COH27A
	HPE StoreEver MSL LTO-6 Ultrium 6250 Fibre Channel Drive Upgrade Kit	COH28A
	HPE StoreEver MSL LTO-5 Ultrium 3000 SAS Drive Upgrade Kit	BL540B
	HPE StoreEver MSL LTO-5 Ultrium 3000 Fibre Channel Drive Upgrade Kit	BL544B
<b>HPE Drives</b>	<b>Enterprise - 12G SAS - SFF Drives</b>	

## Configuration Information – Factory Integrated Models

HPE 300GB SAS 12G Enterprise 15K SFF (2.5in) SC 3yr Wty Digitally Signed Firmware HDD	870753-B21
HPE 300GB SAS 12G Enterprise 10K SFF (2.5in) SC 3yr Wty Digitally Signed Firmware HDD	872475-B21
HPE 600GB SAS 12G Enterprise 10K SFF (2.5in) SC 3yr Wty Digitally Signed Firmware HDD	872477-B21
HPE 900GB SAS 12G Enterprise 15K SFF (2.5in) SC 3yr Wty Digitally Signed Firmware HDD	870759-B21
HPE 1.2TB SAS 12G Enterprise 10K SFF (2.5in) SC 3yr Wty Digitally Signed Firmware HDD	872479-B21
HPE 1.8TB SAS 12G Enterprise 10K SFF (2.5in) SC 3yr Wty 512e Digitally Signed Firmware HDD	872481-B21
HPE 2.4TB SAS 12G Enterprise 10K SFF (2.5in) SC 3yr Wty 512e Digitally Signed Firmware HDD	881457-B21
<b>Enterprise - 12G SAS - LFF Drives</b>	
HPE 900GB SAS 12G Enterprise 15K LFF (3.5in) LPC 3yr Wty Digitally Signed Firmware HDD	870761-B21
HPE 300GB SAS 12G Enterprise 15K LFF (3.5in) LPC 3yr Wty Digitally Signed Firmware HDD	870755-B21
<b>Midline - 12G SAS - SFF Drives</b>	
HPE 1TB SAS 12G Midline 7.2K SFF (2.5in) SC 1yr Wty Digitally Signed Firmware HDD	832514-B21
HPE 1TB SAS 12G Midline 7.2K SFF (2.5in) SC 1yr Wty 512e Digitally Signed Firmware HDD	765464-B21
HPE 2TB SAS 12G Midline 7.2K SFF (2.5in) SC 1yr Wty 512e HDD	765466-B21
<b>Midline - 12G SAS - LFF Drives</b>	
HPE 8TB SAS 12G Midline 7.2K LFF (3.5in) LP 1yr Wty 512e Digitally Signed Firmware HDD	834031-B21
HPE 2TB SAS 12G Midline 7.2K LFF (3.5in) LP 1yr Wty Digitally Signed Firmware HDD	833926-B21
HPE 4TB SAS 12G Midline 7.2K LFF (3.5in) LP 1yr Wty Digitally Signed Firmware HDD	833928-B21
HPE 4TB SAS 12G Midline 7.2K LFF (3.5in) LP 1yr Wty 512e HDD	846996-B21
HPE 6TB SAS 12G Midline 7.2K LFF (3.5in) LP 1yr Wty 512e HDD	846998-B21
HPE 10TB SAS 12G Midline 7.2K LFF (3.5in) LP 1yr Wty Helium 512e Digitally Signed Firmware HDD	857646-B21
HPE 8TB SAS 12G Midline 7.2K LFF (3.5in) LP 1yr Wty Helium 512e Digitally Signed Firmware HDD	861592-B21
HPE 6TB SAS 12G Midline 7.2K LFF (3.5in) LP 1yr Wty 512e HDD	861746-B21
HPE 4TB SAS 12G Midline 7.2K LFF (3.5in) LP 1yr Wty 512e HDD	861748-B21
HPE 3TB SAS 12G Midline 7.2K LFF (3.5in) LP 1yr Wty Digitally Signed Firmware HDD	846530-B21
HPE 1TB SAS 12G Midline 7.2K LFF (3.5in) LP 1yr Wty Digitally Signed Firmware HDD	846526-B21
HPE 6TB SAS 12G Midline 7.2K LFF (3.5in) LP 1yr Wty Digitally Signed Firmware HDD	846516-B21
<b>Midline - 6G SATA SFF Drives</b>	
HPE 1TB SATA 6G Midline 7.2K SFF (2.5in) SC 1yr Wty 512e Digitally Signed Firmware HDD	765453-B21

## Configuration Information – Factory Integrated Models

HPE 2TB SATA 6G Midline 7.2K SFF (2.5in) SC 1yr Wty 512e Digitally Signed Firmware HDD	765455-B21
<b>Midline - 6G SATA - LFF Drives</b>	
HPE 4TB SATA 6G Midline 7.2K LFF (3.5in) LP 1yr Wty Digitally Signed Firmware HDD	861683-B21
HPE 1TB SATA 6G Midline 7.2K LFF (3.5in) LP 1yr Wty Digitally Signed Firmware HDD	861686-B21
HPE 2TB SATA 6G Midline 7.2K LFF (3.5in) LP 1yr Wty Digitally Signed Firmware HDD	861681-B21
HPE 3TB SATA 6G Midline 7.2K LFF (3.5in) LP 1yr Wty Digitally Signed Firmware HDD	861688-B21
HPE 4TB SATA 6G Midline 7.2K LFF (3.5in) LP 1yr Wty 512e HDD	846783-B21
HPE 6TB SATA 6G Midline 7.2K LFF (3.5in) LP 1yr Wty Digitally Signed Firmware HDD	846512-B21
HPE 10TB SATA 6G Midline 7.2K LFF (3.5in) LP 1yr Wty Helium 512e Digitally Signed Firmware HDD	857650-B21
HPE 8TB SATA 6G Midline 7.2K LFF (3.5in) LP 1yr Wty Helium 512e Digitally Signed Firmware HDD	861596-B21
HPE 8TB SATA 6G Midline 7.2K LFF (3.5in) LP 1yr Wty 512e Digitally Signed Firmware HDD	834028-B21
HPE 6TB SATA 6G Midline 7.2K LFF (3.5in) LP 1yr Wty 512e HDD	861742-B21
HPE 4TB SATA 6G Midline 7.2K LFF (3.5in) LP 1yr Wty 512e HDD	861744-B21
<b>SSD Selection</b>	
<b>Write Intensive - 6G SATA - SFF - Solid State Drives</b>	
HPE 400GB SATA 6G Write Intensive SFF (2.5in) SC 3yr Wty Digitally Signed Firmware SSD	872355-B21
HPE 800GB SATA 6G Write Intensive SFF (2.5in) SC 3yr Wty Digitally Signed Firmware SSD	872359-B21
HPE 1.6TB SATA 6G Write Intensive SFF (2.5in) SC 3yr Wty Digitally Signed Firmware SSD	872363-B21
<b>Read Intensive - 12G SAS - SFF Solid State Drives</b>	
HPE 960GB SAS 12G Read Intensive SFF (2.5in) SC 3yr Wty Digitally Signed Firmware SSD	872390-B21
HPE 1.92TB SAS 12G Read Intensive SFF (2.5in) SC 3yr Wty Digitally Signed Firmware SSD	872392-B21
HPE 3.84TB SAS 12G Read Intensive SFF (2.5in) SC 3yr Wty Digitally Signed Firmware SSD	872394-B21
HPE 7.68TB SAS 12G Read Intensive SFF (2.5in) SC 3yr Wty Digitally Signed Firmware SSD	870144-B21
<b>Read Intensive - 12G SAS - LFF Solid State Drives</b>	
HPE 7.68TB SAS 12G Read Intensive LFF (3.5in) LPC 3yr Wty Digitally Signed Firmware SSD	870146-B21
<b>Read Intensive - 6G SATA - SFF - Solid State Drives</b>	
HPE 240GB SATA 6G Read Intensive SFF (2.5in) SC 3yr Wty Digitally Signed Firmware SSD	
HPE 480GB SATA 6G Read Intensive SFF (2.5in) SC 3yr Wty Digitally Signed Firmware SSD	868814-B21

## Configuration Information – Factory Integrated Models

HPE 960GB SATA 6G Read Intensive SFF (2.5in) SC 3yr Wty Digitally Signed Firmware SSD	868818-B21
HPE 1.92TB SATA 6G Read Intensive SFF (2.5in) SC 3yr Wty Digitally Signed Firmware SSD	868822-B21
HPE 3.8TB SATA 6G Read Intensive SFF (2.5in) SC 3yr Wty Digitally Signed Firmware SSD	868826-B21
HPE 240GB SATA 6G Read Intensive SFF (2.5in) SC 3yr Wty Digitally Signed Firmware SSD	868830-B21
HPE 240GB SATA 6G Read Intensive SFF (2.5in) SC 3yr Wty Digitally Signed Firmware SSD	877740-B21
HPE 480GB SATA 6G Read Intensive SFF (2.5in) SC 3yr Wty Digitally Signed Firmware SSD	877746-B21
HPE 960GB SATA 6G Read Intensive SFF (2.5in) SC 3yr Wty Digitally Signed Firmware SSD	877752-B21
HPE 1.92TB SATA 6G Read Intensive SFF (2.5in) SC 3yr Wty Digitally Signed Firmware SSD	877758-B21
<b>Read Intensive - 6G SATA - LFF - Solid State Drives</b>	
HPE 480GB SATA 6G Read Intensive LFF (3.5in) LPC 3yr Wty Digitally Signed Firmware SSD	877750-B21
HPE 960GB SATA 6G Read Intensive LFF (3.5in) LPC 3yr Wty Digitally Signed Firmware SSD	877756-B21
HPE 1.92TB SATA 6G Read Intensive LFF (3.5in) LPC 3yr Wty Digitally Signed Firmware SSD	877762-B21
HPE 3.84TB SATA 6G Read Intensive LFF (3.5in) LPC 3yr Wty Digitally Signed Firmware SSD	877768-B21
<b>Read Intensive - NVMe - SFF - Solid State Drives</b>	
HPE 1TB NVMe x4 Lanes Read Intensive SFF (2.5in) SCN 3yr Wty Digitally Signed Firmware SSD	877984-B21
HPE 2TB NVMe x4 Lanes Read Intensive SFF (2.5in) SCN 3yr Wty Digitally Signed Firmware SSD	877986-B21
HPE 480GB NVMe x4 Lanes Read Intensive SFF (2.5in) SCN 3yr Wty Digitally Signed Firmware SSD	875587-B21
HPE 960GB NVMe x4 Lanes Read Intensive SFF (2.5in) SCN 3yr Wty Digitally Signed Firmware SSD	875589-B21
HPE 1.92TB NVMe x4 Lanes Read Intensive SFF (2.5in) SCN 3yr Wty Digitally Signed Firmware SSD	875591-B21
HPE 500GB NVMe x4 Read Intensive SFF (2.5in) SCN 3yr Wty Digitally Signed Firmware SSD	878006-B21
HPE 1TB NVMe x4 Read Intensive SFF (2.5in) SCN 3yr Wty Digitally Signed Firmware SSD	878008-B21
<b>Read Intensive - SATA - SFF Solid State Drives</b>	
HPE 240GB SATA 6G Read Intensive SFF (2.5in) SC 3yr Wty Digitally Signed Firmware SSD	875503-B21
HPE 480GB SATA 6G Read Intensive SFF (2.5in) SC 3yr Wty Digitally Signed Firmware SSD	875509-B21
HPE 960GB SATA 6G Read Intensive SFF (2.5in) SC 3yr Wty Digitally Signed Firmware SSD	875511-B21
HPE 1.92TB SATA 6G Read Intensive SFF (2.5in) SC 3yr Wty Digitally Signed Firmware SSD	875513-B21

## Configuration Information – Factory Integrated Models

### Mixed Use - 12G SAS - SFF Solid State Drives

HPE 3.2TB SAS 12G Mixed Use SFF (2.5in) SC 3yr Wty Digitally Signed Firmware SSD	872386-B21
HPE 400GB SAS 12G Mixed Use SFF (2.5in) SC 3yr Wty Digitally Signed Firmware SSD	872374-B21
HPE 1.6TB SAS 12G Mixed Use SFF (2.5in) SC 3yr Wty Digitally Signed Firmware SSD	872382-B21
HPE 800GB SAS 12G Mixed Use SFF (2.5in) SC 3yr Wty Digitally Signed Firmware SSD	872376-B21
HPE 400GB SAS 12G Mixed Use SFF (2.5in) SC 3yr Wty Digitally Signed Firmware SSD	873359-B21
HPE 800GB SAS 12G Mixed Use SFF (2.5in) SC 3yr Wty Digitally Signed Firmware SSD	873363-B21
HPE 1.6TB SAS 12G Mixed Use SFF (2.5in) SC 3yr Wty Digitally Signed Firmware SSD	873365-B21
HPE 3.2TB SAS 12G Mixed Use SFF (2.5in) SC 3yr Wty Digitally Signed Firmware SSD	873367-B21
HPE 400GB SAS 12G Write Intensive SFF (2.5in) SC 3yr Wty Digitally Signed Firmware SSD	873351-B21
HPE 800GB SAS 12G Write Intensive SFF (2.5in) SC 3yr Wty Digitally Signed Firmware SSD	873355-B21
HPE 1.6TB SAS 12G Write Intensive SFF (2.5in) SC 3yr Wty Digitally Signed Firmware SSD	873357-B21

### Mixed Use - 12G SAS - LFF Solid State Drives

HPE 1.6TB SAS 12G Mixed Use LFF (3.5in) LPC 3yr Wty Digitally Signed Firmware SSD	872384-B21
HPE 800GB SAS 12G Mixed Use LFF (3.5in) LPC 3yr Wty Digitally Signed Firmware SSD	872380-B21
HPE 400GB SAS 12G Mixed Use LFF (3.5in) LPC 3yr Wty Digitally Signed Firmware SSD	873361-B21
HPE 400GB SAS 12G Mixed Use LFF (3.5in) LPC 3yr Wty Digitally Signed Firmware SSD	873353-B21

### Mixed Use - 6G SAS - LFF Solid State Drives

HPE 480GB SATA 6G Mixed Use LFF (3.5in) LPC 3yr Wty Digitally Signed Firmware SSD	877780-B21
HPE 960GB SATA 6G Mixed Use LFF (3.5in) LPC 3yr Wty Digitally Signed Firmware SSD	877786-B21
HPE 1.92TB SATA 6G Mixed Use LFF (3.5in) LPC 3yr Wty Digitally Signed Firmware SSD	877792-B21

### Mixed Use - 6G SATA - SFF - Solid State Drives

HPE 480GB SATA 6G Mixed Use SFF (2.5in) SC 3yr Wty Digitally Signed Firmware SSD	872344-B21
HPE 960GB SATA 6G Mixed Use SFF (2.5in) SC 3yr Wty Digitally Signed Firmware SSD	872348-B21
HPE 1.92TB SATA 6G Mixed Use SFF (2.5in) SC 3yr Wty Digitally Signed Firmware SSD	872352-B21
HPE 480GB SATA 6G Mixed Use SFF (2.5in) SC 3yr Wty Digitally Signed Firmware SSD	877776-B21
HPE 1.92TB SATA 6G Mixed Use SFF (2.5in) SC 3yr Wty Digitally Signed Firmware SSD	877788-B21
HPE 240GB SATA 6G Mixed Use SFF (2.5in) SC 3yr Wty Digitally Signed Firmware SSD	880295-B21
HPE 480GB SATA 6G Mixed Use SFF (2.5in) SC 3yr Wty Digitally Signed Firmware SSD	875470-B21
HPE 960GB SATA 6G Mixed Use SFF (2.5in) SC 3yr Wty Digitally Signed Firmware SSD	875474-B21



## Configuration Information – Factory Integrated Models

	HPE 1.92TB SATA 6G Mixed Use SFF (2.5in) SC 3yr Wty Digitally Signed Firmware SSD	875478-B21
	HPE 240GB SATA 6G Mixed Use SFF (2.5in) SC 3yr Wty Digitally Signed Firmware SSD	875483-B21
	HPE 960GB SATA 6G Mixed Use SFF (2.5in) SC 3yr Wty Digitally Signed Firmware SSD	877782-B21
	<b>Mixed Use - NVMe - SFF - Solid State Drives</b>	
	HPE 4TB NVMe x4 Mixed Use SFF (2.5in) SCN 3yr Wty Digitally Signed Firmware SSD	878004-B21
	HPE 400GB NVMe x4 Lanes Mixed Use SFF (2.5in) SCN 3yr Wty Digitally Signed Firmware SSD	875593-B21
	HPE 800GB NVMe x4 Lanes Mixed Use SFF (2.5in) SCN 3yr Wty Digitally Signed Firmware SSD	875595-B21
	HPE 1.6TB NVMe x4 Lanes Mixed Use SFF (2.5in) SCN 3yr Wty Digitally Signed Firmware SSD	875597-B21
	HPE 1.6TB NVMe x4 Lanes Mixed Use SFF (2.5in) SCN 3yr Wty Digitally Signed Firmware SSD	877994-B21
	HPE 3.2TB NVMe x4 Lanes Mixed Use SFF (2.5in) SCN 3yr Wty Digitally Signed Firmware SSD	877998-B21
<b>Bezel Kits</b>	HPE Apollo 2000 SFF Bezel Enhanced Kit	874793-B21
	HPE Apollo 2000 LFF Bezel Kit	838518-B21
<b>HPE Smart Array Storage Controllers</b>	HPE Smart Array E208i-p SR Gen10 (8 Internal Lanes/No Cache) 12G SAS PCIe Plug-in Controller	804394-B21
	<b>NOTE: This controller supports 0 Internal SAS/SATA devices</b>	
	HPE Smart Array E208i-p SR Gen10 (8 Internal Lanes/No Cache) 12G SAS PCIe Plug-in Controller	804394-B21
	<b>NOTE: This controller supports 0 Internal SAS/SATA devices</b>	
	HPE Smart Array E208e-p SR Gen10 (8 External Lanes/No Cache) 12G SAS PCIe Plug-in Controller	804398-B21
	<b>NOTE: This controller can support up to 0 internal SAS/SATA devices.</b>	
	<b>NOTE: This controller may be selected to support: SAS Tape Device (External), SAS Storage (External)</b>	
	<b>NOTE: This controller can support up to 0 internal SAS/SATA devices.</b>	
	<b>NOTE: This controller may be selected to support: SAS Tape Device (External), SAS Storage (External)</b>	
	HPE Smart Array P408i-p SR Gen10 (8 Internal Lanes/2GB Cache) 12G SAS PCIe Plug-in Controller	830824-B21
<b>PCIe Accelerators</b>	HPE 4TB PCIe x4 RI HH DS Card	877831-B21
	HPE 2TB PCIe x4 MU HH DS Card	877835-B21
	HPE 1.6TB PCIe x8 Lanes Mixed Use HHHL 3yr Wty Digitally Signed Firmware Card	877825-B21
	HPE 3.2TB PCIe x8 Lanes Mixed Use HHHL 3yr Wty Digitally Signed Firmware Card	877827-B21
	HPE 6.4TB PCIe x8 Lanes Mixed Use HHHL 3yr Wty Digitally Signed Firmware Card	877829-B21
<b>HBA Storage Controllers</b>	HPE StoreFabric SN1600Q 32Gb Single Port Fibre Channel Host Bus Adapter	P9M75A
	HPE StoreFabric SN1600E 32Gb Single Port Fibre Channel Host Bus Adapter	Q0L11A
	HPE StoreFabric SN1600E 32Gb Dual Port Fibre Channel Host Bus Adapter	Q0L12A
	HPE StoreFabric SN1200E 16Gb Dual Port Fibre Channel Host Bus Adapter	Q0L14A
	HPE StoreFabric SN1100Q 16Gb Single Port Fibre Channel Host Bus Adapter	P9D93A
<b>HPE Insight Software</b>	Integrated Lights-Out (iLO)	

## Configuration Information – Factory Integrated Models

	HPE iLO Scale Out	
	HPE iLO Scale-Out including 3yr 24x7 Tech Support and Updates Flex Qty E-LTU	BD776AAE
	HPE iLO Scale-Out 3yr 24x7 Tech Support and Updates Flexible Quantity LTU	BD776A
	HPE iLO Scale-Out including 3yr 24x7 Tech Support and Updates Tracking LTU	BD777A
	HPE iLO Scale-Out 1yr 24x7 Tech Support and Updates Flexible Quantity LTU	BD778A
	HPE iLO Scale-Out including 1yr 24x7 Tech Support and Updates Flex Qty E-LTU	BD778AAE
	HPE iLO Scale-Out including 1yr 24x7 Tech Support and Updates Tracking LTU	BD779A
	HPE Integrated Lights-Out (iLO) Advanced for ProLiant	
	HPE iLO Advanced including 3yr 24x7 Technical Support and Updates E-LTU	E6U64ABE
	HPE iLO Advanced including 3yr 24x7 Technical Support and Updates E-LTU	E6U64ABE
	HPE iLO Advanced including 3yr 24x7 Tech Support and Updates 1-server LTU	BD505A
	HPE iLO Advanced including 3yr 24x7 Tech Support and Updates Flexible Quantity LTU	BD506A
	HPE iLO Advanced including 3yr 24x7 Tech Support and Updates Tracking LTU	BD507A
	HPE iLO Advanced including 1yr 24x7 Technical Support and Updates 1-server LTU	512485-B21
	HPE iLO Advanced including 1yr 24x7 Technical Support and Updates Flexible Quantity LTU	512486-B21
	HPE iLO Advanced including 1yr 24x7 Technical Support and Updates Tracking LTU	512487-B21
	<b>NOTE: For additional license options please see the QuickSpecs at: <a href="http://www.hpe.com/h20195/v2/gethtml.aspx?docname=c04154343">http://www.hpe.com/h20195/v2/gethtml.aspx?docname=c04154343</a></b>	
	<b>NOTE: For more information, visit: <a href="http://www.hpe.com/info/ilo">http://www.hpe.com/info/ilo</a></b>	
<b>USB Flash Kit</b>	HPE 32GB microSD Mainstream Flash Media Kit	700139-B21
	HPE 8GB microSD Enterprise Mainstream Flash Media Kit	726116-B21
<b>Security Hardware</b>	<b>Trusted Platform Module</b>	
	HPE Trusted Platform Module 2.0 Gen10 Option	864279-B21
<b>HPE Smart Array SmartCache License</b>	HPE Smart Array SR SmartCache (Single Key/Single Server) LTU	D7S26A
	HPE Smart Array SR SmartCache (Single Key/Multiple Servers) LTU	D7S27A
	HPE Smart Array SR SmartCache (Single Key/Multiple Servers) E-LTU	D7S27AAE
	HPE Smart Array SR Secure Encryption (Data at Rest Encryption/per Server Entitlement) E-LTU	Q2F26AAE
<b>USB and SD Options</b>	HPE USB US Keyboard/Mouse Kit	631341-B21
	HPE USB UK Keyboard/Mouse Kit	631344-B21
	HPE USB FR Keyboard/Mouse Kit	631346-B21
	HPE USB ES Keyboard/Mouse Kit	631348-B21
	HPE USB DE Keyboard/Mouse Kit	631358-B21
	HPE USB JP Keyboard/Mouse Kit	631360-B21
	HPE USB IT Keyboard/Mouse Kit	631362-B21
	HPE USB CN Keyboard/Mouse Kit	631364-B21
	HPE USB AE Keyboard/Mouse Kit	638212-B21
	HPE USB RU Keyboard/Mouse Kit	638214-B21
	HPE USB IN Keyboard/Mouse Kit	672097-D63
	HPE USB AP/INTL Keyboard/Mouse Kit	672097-373

**Configuration Information – Factory Integrated Models**

HPE USB INTL Keyboard/Mouse Kit	672097-B33
HPE USB PT Keyboard/Mouse Kit	672097-133
HPE USB TR Keyboard/Mouse Kit	672097-143
HPE USB CZ Keyboard/Mouse Kit	672097-223
HPE USB FI Keyboard/Mouse Kit	672097-353
HPE USB SE Keyboard/Mouse Kit	672097-103
HPE USB CH Keyboard/Mouse Kit	672097-113
HPE USB KR Keyboard/Mouse Kit	672097-KD3

**NOTE:** Please see the QuickSpecs for Technical Specifications and additional information: [http://h18000.www1.hpe.com/products/QuickSpecs/13972\\_div/13972\\_div.html](http://h18000.www1.hpe.com/products/QuickSpecs/13972_div/13972_div.html)

HPE 36pin Serial/USB/VGA Dongle Cord Kit	676277-B21
--	------------

## Memory

### HPE Memory

#### General Memory population rules and guidelines:

**NOTE:** For detailed memory configuration rules and guidelines, please use the Online DDR4 Memory Configuration Tool:

<http://www.hpe.com/docs/memory-population-rules>

#### Memory speed:

**NOTE:** For details on the HPE Server Memory speed, visit:

<https://www.hpe.com/docs/memory-speed-table>

DIMM Type	Registered DIMM (RDIMM)				
HPE SKU P/N	815097-B21	876181-B21	815098-B21	835955-B21	815100-B21
SKU Description	HPE 8GB 1Rx8 PC4-2666V-R Kit	HPE 8GB 2Rx8 PC4-2666V-R Kit	HPE 16GB 1Rx4 PC4-2666V-R Kit	HPE 16GB 2Rx8 PC4-2666V-R Kit	HPE 32GB 2Rx4 PC4-2666V-R Kit
DIMM Rank	Single Rank (1R)	Dual Rank (2R)	Single Rank (1R)	Dual Rank (2R)	Dual Rank (2R)
<b>DIMM Capacity</b>	<b>8 GB</b>	<b>8 GB</b>	<b>16 GB</b>	<b>16 GB</b>	<b>32 GB</b>
Voltage	1.2 V	1.2 V	1.2 V	1.2 V	1.2 V
DRAM Depth	1 Gb	512 MB	2 Gb	1 Gb	2 Gb
DRAM Width (bit)	x8	x8	x4	x8	x4
DRAM Density	8 Gb	4 Gb	8 Gb	8 Gb	8 Gb
CAS Latency	19-19-19	19-19-19	19-19-19	19-19-19	19-19-19
DIMM Native Speed (MT/s)	2666	2666	2666	2666	2666
<b>HPE Server Memory Speed (MT/s): Intel Xeon Platinum/Gold 81xx/61xx Processors</b>					
1 DIMM per Channel	2666	2666	2666	2666	2666
2 DIMM per Channel	2666	2666	2666	2666	2666
<b>HPE Server Memory Speed (MT/s): Intel Xeon Gold/Silver 51xx/41xx Processors</b>					
1 DIMM per Channel	2400	2400	2400	2400	2400
2 DIMM per Channel	2400	2400	2400	2400	2400
<b>HPE Server Memory Speed (MT/s): Intel Xeon Bronze 31xx Processors</b>					
1 DIMM per Channel	2133	2133	2133	2133	2133
2 DIMM per Channel	2133	2133	2133	2133	2133

## Memory

DIMM Type	Load-Reduced DIMM (LRDIMM)	
HPE SKU P/N	815101-B21	815102-B21
SKU Description	HPE 64GB 4Rx4 PC4-2666V-L Kit	HPE 128GB 8Rx4 PC4-2666V-L Kit
DIMM Rank	Quad Rank (4R)	Octal Rank (8R)
DIMM Capacity	64 GB	128 GB
Voltage	1.2 V	1.2 V
DRAM Depth	2 Gb	2 Gb
DRAM Width (bit)	x4	x4
DRAM Density	8 Gb	8 Gb
CAS Latency	19-19-19	22-19-19
DIMM Native Speed (MT/s)	2666	2666
<b>HPE Server Memory Speed (MT/s): Intel Xeon Platinum/Gold 81xx/61xx Processors</b>		
1 DIMM per Channel	2666	2666
2 DIMM per Channel	2666	2666
<b>HPE Server Memory Speed (MT/s): Intel Xeon Gold/Silver 51xx/41xx Processors</b>		
1 DIMM per Channel	2400	2400
2 DIMM per Channel	2400	2400
<b>HPE Server Memory Speed (MT/s): Intel Xeon Bronze 31xx Processors</b>		
1 DIMM per Channel	2133	2133
2 DIMM per Channel	2133	2133

**Memory options part number decoder:**

**NOTE:** For Memory technical specifications, including part number decoder visit: <https://www.hpe.com/h20195/v2/gethtml.aspx?docname=c04355083>

## Memory

### Memory Subsystem Architecture

Each Intel® Xeon® Scalable family processor socket contains six memory channels per installed processor with one DIMMs per channel for a total of eight (8) DIMMs or a grand total of sixteen (16) DIMMs for the server.

#### Front of server

HPE ProLiant Apollo 2000 Gen10 server board

2+1+1 slots per channel

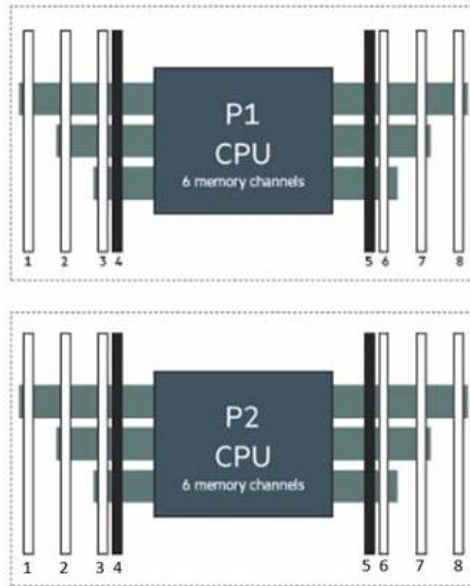

## Technical Specifications

<b>System Unit Specifications</b>	Server Dimensions (L x W x D)	1.63 x 7.27 x 25.91 in (4.13 x 18.45 x 65.80 cm)		
	Weight (approximate)	Maximum	15.23lb (6.91 kg)	
	System Inlet Temperature Standard Operating Support	10° to 35°C (50° to 95°F)	At sea level with an altitude derating of 1.0°C per every 305 m (1.8°F per every 1000 ft) above sea level to a maximum of 3050 m (10,000 ft), no direct sustained sunlight. Maximum rate of change is 20°C/hr (36°F/hr). The upper limit and rate of change may be limited by the type and number of options installed.	
	Extended Ambient Operating Support	10° to 5°C (50° to 41°F) and 35° to 40°C (95° to 104°F)	System performance during standard operating support may be reduced if operating with a fan fault or above 30°C (86°F). For approved hardware configurations, the supported system inlet range is extended to be: 5° to 10°C (41° to 50°F) and 35° to 40°C (95° to 104°F) at sea level with an altitude derating of 1.0°C per every 175 m (1.8°F per every 574 ft) above 900 m (2953 ft) to a maximum of 3050 m (10,000 ft). The approved hardware configurations for this system are listed at the URL: <b><a href="http://www.hpe.com/servers/ashrae">http://www.hpe.com/servers/ashrae</a></b> For approved hardware configurations, the supported system inlet range is extended to be: 40° to 45°C (104° to 113°F) at sea level with an altitude derating of 1.0°C per every 125 m (1.8°F per every 410 ft) above 900 m (2953 ft) to a maximum of 3050 m (10,000 ft). The approved hardware configurations for this system are listed at the URL: <b><a href="http://www.hpe.com/servers/ashrae">http://www.hpe.com/servers/ashrae</a></b> System performance may be reduced if operating in the extended ambient operating range or with a fan fault.	
		-30° to 60°C (-22° to 140°F).	Maximum rate of change is 20°C/hr (36°F/hr).	
	Relative Humidity (non-condensing) Operating	8% to 90%	Relative humidity (Rh), 28°C maximum wet bulb temperature, non-condensing.	
	Non-operating	5 to 95%	Relative humidity (Rh), 38.7°C (101.7°F) maximum wet bulb temperature, non-condensing.	
	Altitude Operating	3050 m (10,000 ft).	This value may be limited by the type and number of options installed. Maximum allowable altitude change rate is 457 m/min (1500 ft/min).	
	Non-operating	9144 m (30,000 ft).	Maximum allowable altitude change rate is 457 m/min (1500 ft/min).	

## Technical Specifications

**Acoustic Noise** Listed are the declared A-Weighted sound power levels (LWAd) and declared average bystander position A-Weighted sound pressure levels (LpAm) when the product is operating in a 23°C ambient environment. Noise emissions were measured in accordance with ISO 7779 (ECMA 74) and declared in accordance with ISO 9296 (ECMA 109). The listed sound levels apply to standard shipping configurations. Additional options may result in increased sound levels.

**NOTE:** Please have your HPE representative provide information from the HPE EMESC website for further technical details regarding the configurations listed below.  
[r2200 Chassis](#)

Configuration SKU	Entry	Base Idle	Performance
LWAd	6.7 B	7.8 B	8.4 B
LpAm	52 dBA	62 dBA	70 dBA
Operating			
LWAd	6.9 B	8.2 B	8.9 B
LpAm	53 dBA	66 dBA	74 dBA

**r2600 Chassis**

Configuration SKU	Entry	Base Idle	Performance
LWAd	6.7 B	7.7 B	7.9 B
LpAm	52 dBA	64 dBA	68 dBA
Operating			
LWAd	6.9 B	8.0 B	8.7 B
LpAm	54 dBA	66 dBA	70 dBA

**r2800 Chassis**

Configuration SKU	Entry	Base Idle	Performance
LWAd	6.7 B	7.7 B	7.9 B
LpAm	52 dBA	64 dBA	68 dBA
Operating			
LWAd	8.6 B	8.6 B	8.7 B
LpAm	69 dBA	70 dBA	70 dBA

**NOTE:** Acoustics levels presented here are generated by the test configuration only. Acoustics levels will vary depending on system configuration. Values are subject to change without notification and are for reference only.



## Technical Specifications

### Thermal Limitations:

Chassis	12 LFF front end : 9-12 drives	12 LFF front end : 0-8 drives (Removable drive blank at Bay 2)	24 SFF combo front end	16 NVME front end
<b>Processor</b>	150W and 140W SKUs limited to 30C amb.	No limitation	No limitation	No limitation
<b>DIMM</b>	Non-redundant fan SKU : No limitation  Redundant fan SKU : 128GB and 64GB LRDIMMs not supported, 32GB RDIMM limited to 30C amb.	Non-redundant fan SKU : No limitation  Redundant fan SKU : 128GB LRDIMM limited to 30C amb.	Non-redundant fan SKU : No limitation  Redundant fan SKU : 128GB LRDIMM limited to 30C amb.	No limitation
<b>Storage card</b>	P408i-p & P408e-p limited to 25C amb.	P408i-p & P408e-p limited to 30C amb.	P408i-p & P408e-p limited to 28C amb.	P408i-p & P408e-p limited to 30C amb.
<b>PCIe NIC card</b>	TBD	TBD	TBD	TBD
<b>ALOM</b>	TBD	TBD	TBD	TBD
<b>mLOM card</b>	TBD	TBD	TBD	TBD
<b>InfiniBand</b>	TBD	TBD	TBD	TBD
<b>FC HBA</b>	TBD	TBD	TBD	TBD
<b>Fabric adaptor</b>	TBD	TBD	TBD	TBD

### Environment-friendly Products and Approach - End-of-life Management and Recycling

Hewlett Packard Enterprise offers end-of-life product return, trade-in, and recycling programs, in many geographic areas, for our products. Products returned to Hewlett Packard Enterprise will be recycled, recovered or disposed of in a responsible manner.

The EU WEEE Directive (2012/19/EU) requires manufacturers to provide treatment information for each product type for use by treatment facilities. This information (product disassembly instructions) is posted on the Hewlett Packard Enterprise web site: <http://www.hpe.com/RECYCLE>. These instructions may be used by recyclers and other WEEE treatment facilities as well as Hewlett Packard Enterprise OEM customers who integrate and re-sell Hewlett Packard Enterprise equipment.

## Summary of Changes

Date	Version History	Action	Description of Change
9-Oct-2017	From version 1 to 2	Updated	Update SKUs descriptions
25-Sept-2017	Version 1	Created	Create QuickSpecs for HPE ProLiant XL170r Gen10 Server

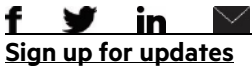

© Copyright 2017 Hewlett Packard Enterprise Development LP. The information contained herein is subject to change without notice. The only warranties for Hewlett Packard Enterprise products and services are set forth in the express warranty statements accompanying such products and services. Nothing herein should be construed as constituting an additional warranty. Hewlett Packard Enterprise shall not be liable for technical or editorial errors or omissions contained herein.

Microsoft and Windows NT are US registered trademarks of Microsoft Corporation.

Intel, the Intel logo, Xeon and Xeon Inside are trademarks of Intel Corporation in the U.S. and other countries.

Linux is a registered trademark of Linus Torvalds.

SUSE is a registered trademark of Suse. Ubuntu and Canonical are registered trademarks of Canonical Ltd. Red Hat is a trademark of Red Hat, Inc. in the U.S. and other countries.

VMware is a registered trademark of VMware, Inc. in the United States and/or other jurisdictions.

For hard drives, 1GB = 1 billion bytes. Actual formatted capacity is less.

a00022816enw - 16064 - Worldwide - V2 -9-October-2017