

User Manual
v1.01

M215 SC Bundle

M200SC Base Station and M15SC Handset

TABLE OF CONTENTS

Copyright, Trademarks, Legal Disclaimers	6
Important Information	7
Suitable and Unsuitable Locations	7
Intended Use	7
Safety Precautions	7
SELV (Safety Extra Low Voltage) Compliance	9
Important Battery Information	9
Cleaning	10
Disposal	11
Standards Conformance	11
Technical Specifications	12
Introduction	13
Setting Up	14
Delivery Content	14
Hardware Setup	14
M200 SC Base Station	14
M15 SC Handset	16
Getting to know	18
M200 SC base station	18
Handset locator button	18
LED Status Indicator	18
Reset Key	19
M15 SC handset	20
At a glance	20
Handset front	20
Handset rear and right side	21
LED indicators and keypad illumination	21
Display screen	21
Display screen navigation	22
Hard Keys	22
Context-sensitive function keys	22
Navigation keys	23
Dedicated function keys	23
Call keys	23
Alphanumeric keys	24
Using the phone	25
Registering the handset to the base station	25
Changing the name of the handset	26
Deregistering the handset from the base station	27
Locating the handset	28

Making calls	28
Selecting identity for current outgoing call	28
Using a wired headset	29
Using different dialing methods	29
Dialing manually	29
Redialing	29
Calling number from call history (missed, received, dialed calls)	29
Calling number from phone directory	29
Speed dialing	30
Making an intercom call	30
Accepting calls	30
Call Waiting	31
Active calls	31
Hold	31
Putting a call on hold	31
Making a call with a call on hold	32
Connecting the active call to the call on hold	32
Switching between two calls	32
Conference	33
Starting a conference with a held call	33
Transferring calls	34
Attended transfer	34
Transferring an active call to a held call	35
Blind transfer	35
Ending calls	36
Listening to messages	36
Call history	36
Calling a number on a call list	37
Saving a number to the directory	37
Deleting an entry from the list	38
Deleting a call list	38
Rejecting or redirecting incoming calls	38
Rejecting anonymous calls	38
Do not disturb (DND)	38
Call forwarding	39
Directories	40
Local directory, base directory, blacklist	40
Calling a number from the directory	40
Adding a contact to local directory, base directory, blacklist	41
Editing an entry in local directory, base directory, blacklist	41
Deleting an entry from local directory, base directory, blacklist	42
Deleting all entries in local directory, base directory, blacklist	42
LDAP search	42

Configuring the handset	43
Menus	43
Main menu	43
Speed dial	44
Features	44
Hiding your caller ID	44
Answering calls by removing handset from charger	45
Missed call alert	45
Call waiting	45
Status	46
User settings	46
Language	47
Date/time	47
Contrast	47
Ringtone and ringtone volume	48
Info tones low battery, lost link, and key touch tones	49
Admin settings	49
Base station web user interface (WUI)	50
Default user names and passwords	50
Finding the IP address of the base station	50
Accessing the WUI	50
WUI structure and handling	51
Main menu	51
User settings	52
System page	52
Contacts page	52
Servicing page	54
Admin settings	54
Appendix 1 - Base Station Settings	55
User Settings	55
Admin settings	55
System	55
System Account Management	55
Call Settings	58
User Preferences Settings	58
Handset Settings	58
Network Settings	59
Basic Network Settings.....	59
Advanced Network Settings.....	59
Contacts	60
Base directory settings	60
Blacklist (deny list) settings	60
LDAP settings	60

Servicing pages	61
Reboot	61
Time and Date	61
Firmware Upgrade	63
Provisioning settings	63
Security Settings	64
Certificates	64
System Logs	65

Copyright, Trademarks, Legal Disclaimers

© 2017 Snom Technology GmbH. All Rights Reserved.

Snom, the names of Snom products, and Snom logos are trademarks owned by Snom Technology GmbH. All other product names and names of enterprises are the property of their respective owners.

Product specifications are subject to change without notice.

Snom Technology GmbH reserves the right to revise and change this document at any time, without being obliged to announce such revisions or changes beforehand or after the fact.

Texts, images, and illustrations and their arrangement in this document are subject to the protection of copyrights and other legal rights worldwide. Their use, reproduction, and transmittal to third parties without express written permission may result in legal proceedings in the criminal courts as well as civil courts.

When this document is made available on Snom's web page, Snom Technology GmbH gives its permission to download and print copies of its content for the intended purpose of using it as a manual. No parts of this document may be altered, modified or used for commercial purposes without the express written consent of Snom Technology GmbH.

Although due care has been taken in the compilation and presentation of the information in this document, the data upon which it is based may have changed in the meantime. Snom therefore disclaims all warranties and liability for the accurateness, completeness, and currentness of the information published, except in the case of intention or gross negligence on the part of Snom or where liability arises due to binding legal provisions.

Important Information

The M215 SC bundle contains one M200 SC base station with Ethernet cable and one M15 SC handset, a rechargeable battery pack, and one handset charger plus power adapter.

Suitable and Unsuitable Locations

Please read the precautions and instructions on how to install the product thoroughly.

- The product is for indoor installation only. Not for outdoor installation!
- The operational temperature for the product is between -5 °C and + 45 °C. The charging temperature for the handset is between +5 °C and +40 °C.
- The maximum humidity for the product is 95% noncondensing. Do not install product in rooms with high humidity (for example, in bathrooms, laundry rooms, damp basements).
- Do not install the product in locations where it may get splashed with water or chemicals.
- Do not install the product in surroundings at risk for explosions and do not use the product in such surroundings (paint shops, for example).
- Do not install the product near air conditioners or air conditioning vents, radiators, in very dusty surroundings, or where it is exposed to direct sunlight.
- Avoid placing the device's Ethernet cable where people may trip over it. Avoid placing the cable where it may be exposed to mechanical pressure as this may damage it. If the cable is damaged, disconnect the device and contact qualified service personnel.
- Proximity to metal surfaces , electric current lines, and water pipes might degrade signal reception/ transmission. We recommend to not install the product directly on metal surfaces and to maintain a minimum distance of 20 cm from electric current lines and water pipes.
- Medical devices might be adversely affected. Please consider the technical ramifications when installing the device in a doctor's office, for example.
- Install the base station at a minimum distance of 100 cm to persons and animals.

Intended Use

The handset M15SC is designed for use with the M200SC base station. The M200SC base station is designed for use with the M15SC handset. Any other use is considered unintended use. Any modification or reconstruction not described in the user manual is considered unintended use.

Safety Precautions

Please read these precautions and the instructions on how to set up and use the device thoroughly before using it. Save this info sheet and do not give the device to third parties without it. Please also note the information on the proper disposal of the device.

- **Warning:** Power adaptors shall be installed near the equipment and shall be easily accessible.
- Avoid placing the device's Ethernet cable and power cord where people may trip over them. Avoid placing the cable where it may be exposed to mechanical pressure as this may damage it. If the power cord is damaged, disconnect the device and contact qualified service personnel.

- The product is for indoor installation only. Not for outdoor installation!
- The operational temperature for the product is between -5 °C and + 45 °C, maximum humidity 95% noncondensing. The charging temperature for the handset is between +5 °C and +40 °C.
- Do not install product in rooms with high humidity (for example, in bathrooms, laundry rooms, damp basements). Do not immerse product in water and do not spill or pour liquids of any kind onto or into any parts of it.
- Do not install product in surroundings at risk for explosions and do not use the product in such surroundings (paint shops, for example). Do not use the product if you smell gas or other potentially explosive fumes!
- Install the base station at a minimum distance of 100 cm to persons and animals.
- Medical devices might be adversely affected. Please consider the technical ramifications when installing the device in a doctor's office, for example.
- **Warning:** The handset contains a magnet, and its earpiece may attract small dangerous objects such as needles or pins. Please ensure before each use that no such objects are present.

If you have an implanted pacemaker

- Do not use if you have an implanted pacemaker unless the pacemaker manufacturer's directions expressly permit the use of devices emitting pulsating radio frequency signals. Always follow the manufacturer's directions!
- Recommended MINIMUM distance to the device: 100 cm.
- Turn the device off immediately if there is any reason to suspect that interference is taking place.

Additional safety information

Small children

Your device and its enhancements may contain small parts. Keep them out of the reach of small children.

Operating environment

Remember to follow any special regulations in force in any area, and always switch off your device when its use is prohibited or when it may cause interference or danger. Use the device only in its normal operating positions. Do not place credit cards or other magnetic storage media near the device, because information stored on them may be erased.

Medical devices

Operation of any equipment emitting radio frequency signals may interfere with the functionality of inadequately shielded medical devices. Consult a physician or the manufacturer of the medical device to determine if they are adequately shielded from external radio frequency (RF) energy or if you have any other questions concerning this topic. Switch off your device in health care facilities when signs posted in these areas instruct you to do so. Hospitals or health care facilities may be using equipment that could be sensitive to external RF energy.

Implanted medical devices

Manufacturers of medical devices recommend that a minimum distance should be maintained between a wireless device and an implanted medical device, such as pacemakers or cardioverter defibrillators, to avoid potential interference with the medical device. Persons who have such devices should:

- Always keep the wireless device more than 100 centimeters from the medical device when the wireless device is turned on.

- Keep a minimum distance of 100 cm to the base station.
- Keep a minimum distance of 20 cm to the handset.
- Not carry the wireless device in a breast pocket.
- Hold the wireless device to the ear opposite the medical device to minimize the potential for inter-ference.
- Turn the wireless device off immediately if there is any reason to suspect that interference is taking place.
- Read and follow the directions of the medical device's manufacturer.
- If you have any questions about using your wireless device with an implanted medical device, consult your health care provider.

Other health risks

Do not hold the loudspeaker at the back of the handset against your ear when the phone is ringing or when speakerphone is switched on. **Danger of serious, irreversible damage to your hearing!**

If you are wearing a hearing aid

Please note that the handset may cause an annoying background noise.

Potentially explosive environments

Switch off your device when in any area with a potentially explosive atmosphere and obey all signs and instructions. Sparks in such areas could cause an explosion or fire resulting in bodily injury or even death. Switch off the device at refuelling points such as near gas pumps at service stations. Observe restrictions on the use of radio equipment in fuel depots, storage, and distribution areas; chemical plants; or where blasting operations are in progress. Areas with a potentially explosive atmosphere are often but not always clearly marked. They include below deck on boats, chemical transfer or storage facilities, vehicles using liquefied petroleum gas, and areas where the air contains chemicals or particles such as grain dust or metal powders.

Sensitive Electronic Equipment

The current state of research concludes that operational DECT phones normally do not adversely affect electronic equipment. Nevertheless, you should take some precautions if you want to operate DECT phones in the immediate vicinity of such equipment like sensitive laboratory equipment. Always keep a minimum distance of 10 cm to the equipment even when the phone is in standby.

Electrical Surges

We recommend the installment of an AC surge arrester in the AC outlet to which this device is connected to avoid damage to the equipment caused by local strikes of lightning or other electrical surges

SELV (Safety Extra Low Voltage) Compliance

Safety status of Input/Output connections comply with SELV requirements.

Important Battery Information

The handset uses a rechargeable battery pack,

Model name	Supplier
Ni-MHAAA550mAh 2.4V (NI-MHAAA550*2)	Yiyang Corun Battery Co., Ltd.

Only use the batteries that came with the handset or suitable replacement batteries recommended by Snom. Do not use any other type of battery since this may lead to leakage, fire, explosion, or other dangerous situations. Never disassemble, alter, or short-circuit batteries or use them for purposes other than the intended one. Charge battery only within the handset placed in the charger that came with the product.

Charging and Discharging, Storage

- CAUTION: Risk of explosion if battery is replaced by an incorrect type. Dispose of used batteries according to the instructions.
- The full performance of a new battery is achieved only after two or three complete charge and discharge cycles.
- The battery can be charged and discharged hundreds of times, but it will eventually wear out. Use only Snom Technology GmbH approved batteries.
- If left unused, a fully charged battery will lose its charge over time. If the batteries are completely discharged, it may take a few minutes before the charging indicator appears on the display.
- Use the batteries only for their intended purpose. Do not short-circuit the batteries. Short-circuiting the terminals may damage the batteries or the connecting object. Do not use a damaged charger or battery. Using a damaged battery may cause it to explode.
- Do not place or store the batteries, inside or outside the handset, in the immediate vicinity of open fire or other heat sources.
- Leaving the batteries in hot or cold places will reduce their capacity and lifetime. Charge batteries within an ambient temperature range of +5 °C to +40 °C). A device with hot or cold batteries may not work temporarily, even when the batteries are fully charged.
- Avoid overcharging. Repeated overcharging can lead to deterioration in battery performance. Never attempt charging the batteries with reversed polarity as this may cause the gas pressure inside the batteries to rise and lead to leakages.
- Remove batteries if storing phone for more than 1 month.
- Store batteries in a cool, dry place without corrosive gases. Storage up to 6 months: Charge battery to 30% to 70% of its capacity and store at -10 °C and +40 °C, relative humidity approx. 50%.

Battery Disposal

Defective or exhausted batteries should never be disposed of as municipal waste. Return old batteries to the battery supplier, a licensed battery dealer or a designated collection facility. Do not incinerate batteries.

Cleaning

Use an anti-static cloth. Please avoid water and liquid or solid cleaning products as they might damage the surface or internal electronics of the base, charger, and handset.

Disposal

Handset, Charger, and Power Supply



This product is subject to European Directive 2012/19/EU and may not be disposed of with general household garbage.

If you do not know where you may dispose of the device at the end of its lifespan, contact your municipality, your local waste management provider, or your seller.

Battery



The battery provided with this product is subject to European Directive 2006/66/EC and may not be disposed of with general household garbage. If you do not know where you may dispose of the battery at the end of its lifespan, contact your municipality, your local waste management provider, or your seller.

For countries outside the European Union

Disposal of electrical and electronic products and batteries in countries outside the European Union should be done in line with local regulations. Please contact local authorities for further information.

Standards Conformance



This device complies with the essential health, safety, and environmental requirements of all relevant European directives. Unauthorized opening, changing, or modifying the device will cause the warranty to lapse and may also result in the loss of CE conformity. In case of malfunction contact authorized service personnel, your seller, or Snom.

The declaration of conformity can be requested from

Snom Technology GmbH
Wittestr. 30G
13509 Berlin, Germany

- **Safety:** IEC 60950
- **Base station connectors**
 - **Ethernet network port:** 10/100 Mbps, RJ 45 (8P8C)
 - **Power adaptor:** Coaxial connector
- **Power of M15 handset charger**
 - **EU:** Ten Pao, model number S004LV0600030
 - **UK:** Ten Pao, model number S004LB0600030
- **Power of M200 base station**
 - **Power over Ethernet (PoE):** IEEE 802.3af, Class 2
 - If PoE is not available, order the separately available power adapter (not included in delivery):
 - **EU:** Snom A6, Phihong model number PSM10R-050 (PN 00004325); **UK clip** available separately
 - **EU:** Ten Pao, model number S004LV0500080 (PN 00004373)
 - **UK:** Ten Pao, model number S004LB0500080 (PN 00004374)

Technical Specifications

Frequency band:	1881.792-1897.344 MHz (EMEA)
Operating temperature:	-5 - +45° C
Battery type:	Rechargeable battery pack, NiMH 2.4 V, minimum charge 550 mAh
Talk time:	Up to 7 hours
Standby time:	Up to 7 days
Charging time:	From empty to full up to 8 hours
Wired headset jack:	2.5 mm standard phone jack
Power connector:	Coaxial

Introduction

In a typical telephony system, the IP DECT base station is connected to the local area network (LAN) which, in turn, is connected to a PBX or an IP Service Provider. The base station converts IP protocol to DECT protocol and transmits phone calls to and from the DECT handsets.

To be able to use the M-series DECT phones, the base station must be connected to your LAN and the handset(s) must be registered at the base station. This manual covers the manual configuration of one base station and one handset.

The base station follows most Snom configuration and management schemes. It is recommended to have a local HTTP/HTTPS server for firmware updates, central configuration management, and hosting firmware files for base stations, handsets, and repeaters. Handsets are updated over the air by the base station.

Normally the initialization of the base station is completely automatic, using DHCP. If the base station cannot discover a DHCP server in the subnet, you can set it up manually via its web interface. As a minimum you will need to enter the IP address, netmask, IP gateway, and DNS server. Your VoIP service provider or your network may require more data; please ask your provider or your network's administrator for the requisite input.

Setting Up

Delivery Content



- M200 SC base station
 - Wall bracket for M200 SC
 - Ethernet cable for M200 SC
- M15 SC handset
 - Lid for SC battery compartment
 - Battery pack for M15 SC
 - Charger for M15 SC
 - Power adaptor for charger
 - Quick Installation Guide

Hardware Setup

M200 SC Base Station

The base station is provided with both power and the network connection via PoE (Power over Ethernet). The PoE cable is connected to the RJ 45 connector on the unit. If your network does not have a PoE infrastructure, you can use a separately available power adapter (not included in delivery):

- **EU:** Snom A6, Pihong model number PSM10R-050 (PN 00004325); **UK** clip available separately
- **EU:** Ten Pao, model number S004LV0500080 (PN 00004373)
- **UK:** Ten Pao, model number S004LB0500080 (PN 00004374)

The base station is delivered ready to be placed on a desktop, shelf, cabinet, or on the floor. With the wall bracket included in the delivery, it can also be hung on a wall.

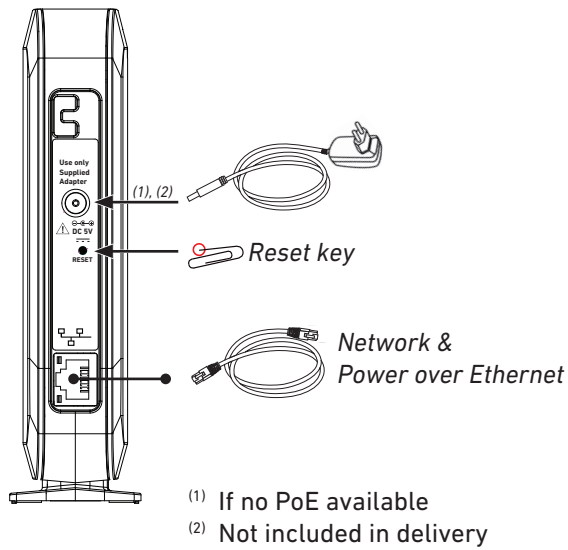

Fig. 1

Standing Unit

1. Connect the Ethernet cable to the RJ45 jack on the side of the device (see Fig. 1, above) and to your network router or switch.
2. If a power adaptor is necessary, connect it to the coaxial connector on the side of the device (see Fig. 1, above) and to an electrical wall outlet.

Wall Mounting

Prior to mounting the device on the wall, you must attach the wall bracket to the back of the base station. The bracket has two holes for hanging the unit on two screws or hooks on a wall.

Note: Screws/hooks and wall anchors are not included in the delivery. Use screws and wall anchors suitable for your wall. Select screws with heads of a minimum of 5 mm (0.1969") in diameter.

1. Attaching the wall bracket.

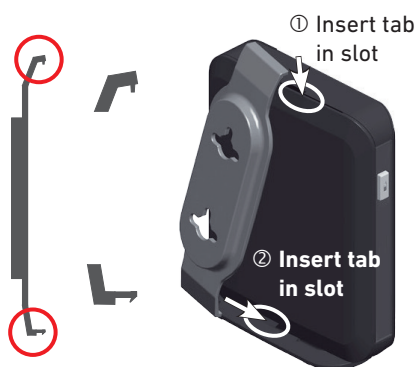

Fig. 2

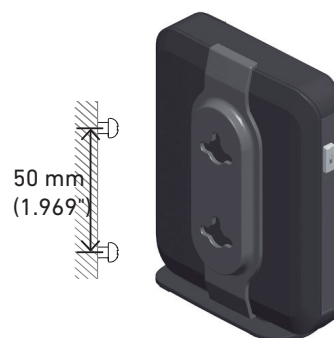

Fig 3

- a. Insert the short tab (Fig. 2, step 1) on the bracket in the slot at the top of the base station.
- b. Insert the longer tab (Fig. 2, step 2) on the bracket in the slot in the base station's footstand until it clicks into place. Check to make sure the bracket is securely attached to the base station.

2. Installing the mounting screws.

- a. Mark the centers of the two holes on the wall. The centers have to be 60 mm (2.3622") apart horizontally (see Fig. 3 on page 15).

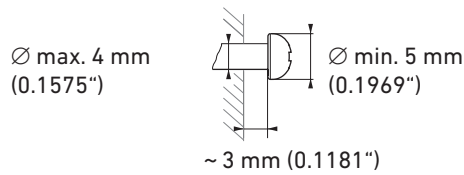

Fig. 4

- b. Drill the holes and insert the wall anchors flush to the wall.
 - c. Tighten the screws until only 3 (0.1181") mm protrude from the wall (Fig. 4).
3. Place the two holes on the bracket over the screws on the wall and gently pull the base station down on the screws until they lock into place.
4. Connect the Ethernet cable to the RJ45 jack on the side of the device (see Fig. 1 on page 15) and to your network router or switch. If a power adaptor is necessary, connect it to the coaxial connector on the side of the device (see Fig. 1 on page 15) and to an electrical wall outlet.

Detaching the Wall Bracket

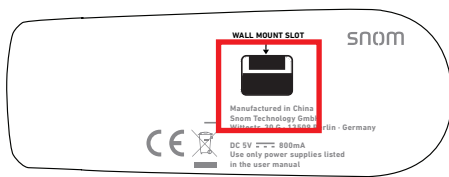

Fig. 5

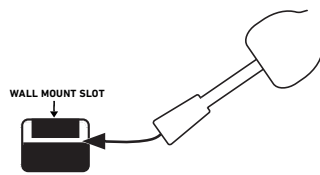

Fig. 6

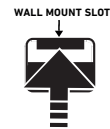

Fig. 7

- 1. Insert the flat blade of a slotted screwdriver in the slot labelled "Wall Mount Slot" underneath the footstand (Fig. 5 and 6).
- 2. Push the blade (in the opposite direction of the arrow marking underneath the "Wall Mount Slot" label) to release the catch holding the bracket in place (Fig. 7).

M15 SC Handset

Before first use of the handset, its battery pack should be fully charged; this will take approximately 11 hours of continuous charging. For best performance, keep the handset in the charger when you are not using it.

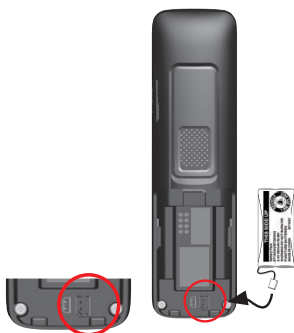

Fig. 1



Fig. 2



Fig. 3

1. Plug the battery connector into the socket inside the battery compartment (see Fig. 1 on page 16) and insert the battery pack with the label "THIS SIDE UP" facing upward (Fig. 2).
2. Place the cover on the compartment so that it is flush with the compartment's edges and slide it upwards until it clicks into place (Fig. 3).
3. Connect the coaxial plug of the power adaptor to the handset's charger as shown in Fig. 4 and connect the adaptor to an electrical wall outlet (Fig. 5).



Fig. 4

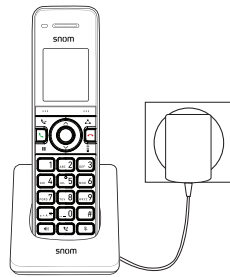



Fig. 5









Battery charging status

The battery symbol in the upper right corner of the display indicates the battery's charging status.

Battery indicators	Battery Status	Action
The display is blank or shows Place in charger and the battery symbol flashes.	The battery has no or very low charge. The handset cannot be used.	Charge without interruption for at least 30 minutes.
The display shows Low battery and the battery symbol flashes.	The battery has enough charge to be used for a short time.	Charge without interruption for at least 30 minutes.
The full battery icon  appears.	The battery is charged.	To keep the battery charged, place it in the charger when not in use.

When the handset is off the charger, the battery symbol indicates the current charge status. When the handset is in the charger, the flashing battery symbol indicates the charge status, beginning with the current status.

Battery symbol	Current charge status	Symbol flashes when handset is in charger
	Empty or very low charge. The battery has been charging for less than 30 minutes.	
	The battery has been charging for 30 to 80 minutes.	
	The battery has been charging for 80 minutes to seven hours.	
	The battery has been charging for more than seven hours. The battery is fully charged after charging continuously for 11 hours.	

Getting to know

M200 SC base station

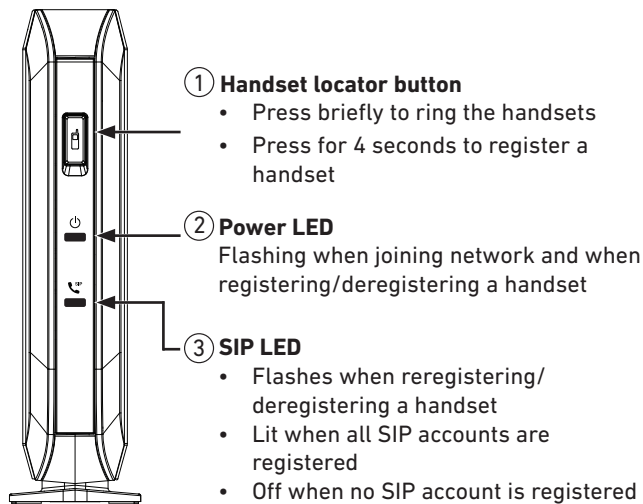

Fig. 1

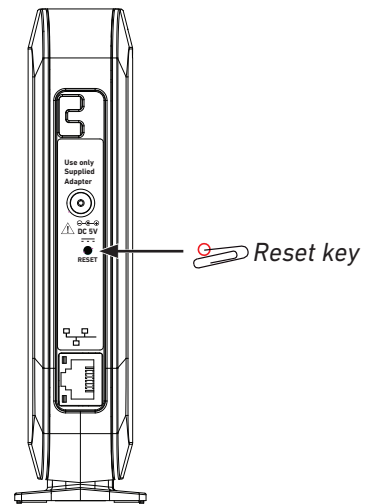

Fig. 2



Handset locator button

The handset locator button serves two purposes:

- Pressed briefly, it pages all handsets registered at the base station.
- Pressed for four seconds, it will register any M15 SC handset set in registration mode.

LED Status Indicator

After the PoE cable - or the PoE cable and the power adaptor, if PoE is not available - is connected to the unit, the orange LEDs will begin to blink, indicating that the unit is booting. When the solid green LEDs come on, the unit is connected to the network and is operational.

- **Power LED** 
 - Flashing
 - When the base station is joining the network.
 - When the base station is registering/deregistering a handset.
 - Steady: The base station is connected to power and network and has a valid IP address.
- **SIP LED** 
 - Flashing when registering/deregistering a handset.
 - Steady when at least one SIP account is enabled in the SIP Account Management settings on the web user interface (WUI).
 - Off when no SIP account is enabled in the SIP Account Management settings on the WUI.

Reset Key

The reset key on the connector side of the base station (see Fig. 2, above) is used to return the settings to factory defaults. To perform a factory reset, press the key with an object like the end of a paper clip for approximately 10 seconds.

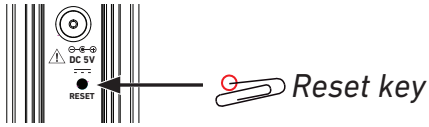

M15 SC handset

At a glance

Handset front

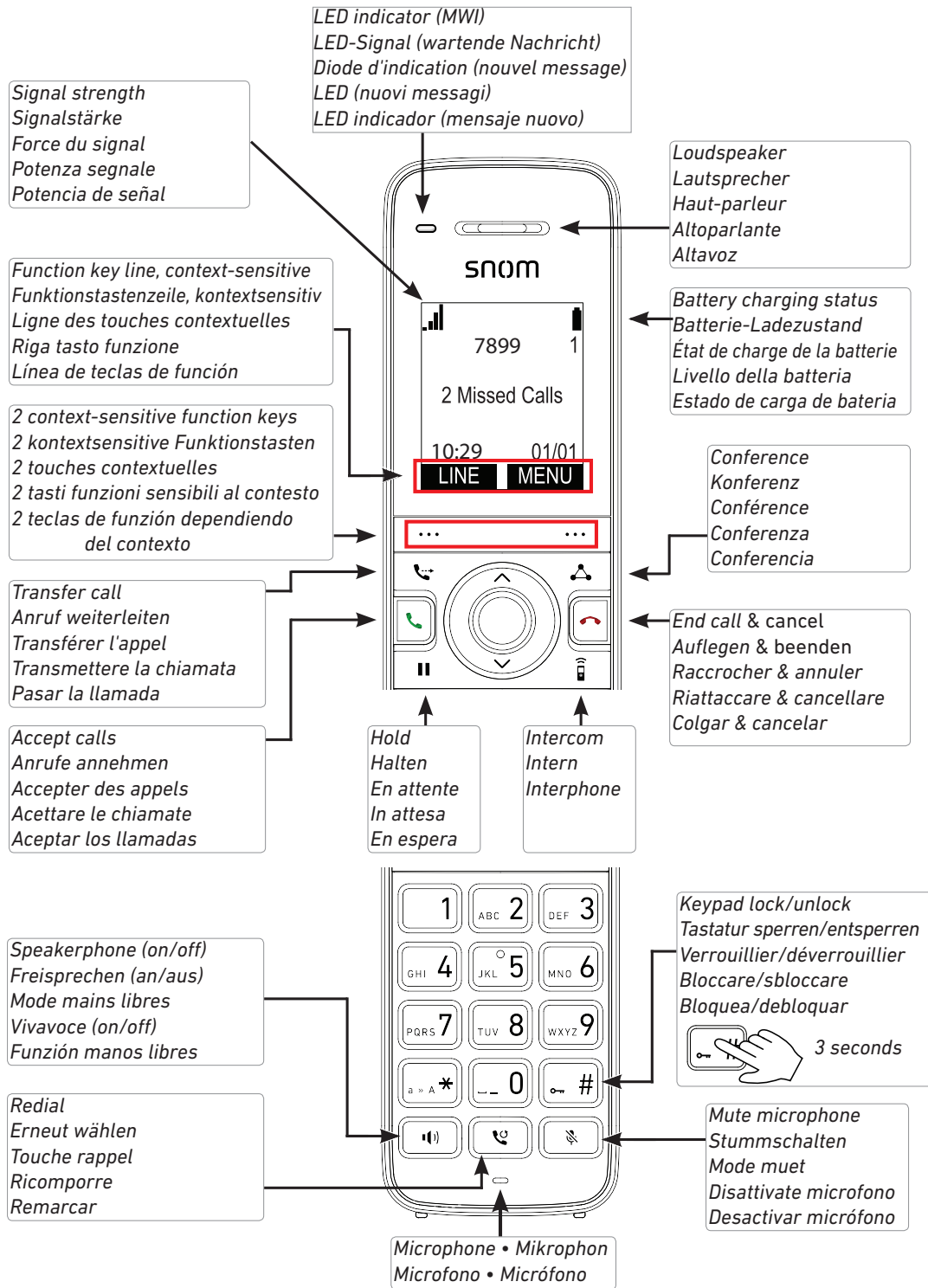

Handset rear and right side

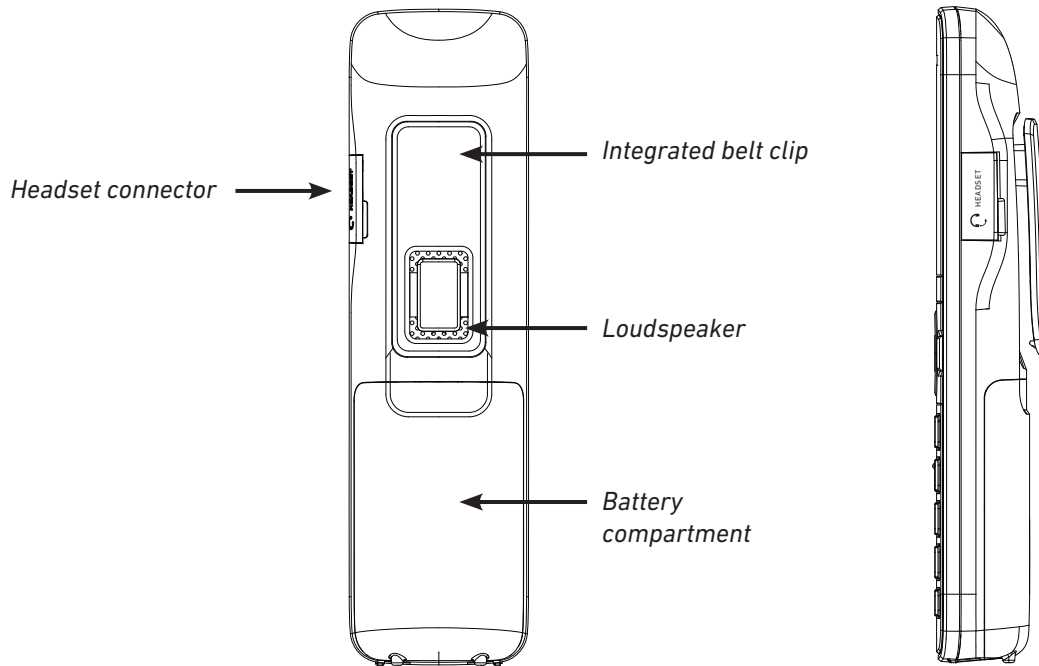

- Headset connector. On the side of the handset is a 2.5 mm audio jack for connecting a wired, IP-capable headset.
- Rear loudspeaker. The rear loudspeaker is located underneath the integrated belt clip.
- Battery compartment. For information on how to open and close the compartment and on how to replace the battery, see the instructions on page 16.

LED indicators and keypad illumination

- Message Waiting Indicator (MWI). When there are new messages on the mailbox, the LED is lit, and the phone displays the "New Messages" notification. See "Listening to messages" on page 36 on how to listen to them.
- Keypad illumination. The number keys and the star and pound (hash) keys are illuminated for approximately 10 seconds every time any hard key on the handset is pressed.
- Speakerphone LED. The red LED on the speakerphone lights up when and for as long as speakerphone is turned on. Pressing the key a second time will turn off both speakerphone mode and the LED on the key.

Display screen

Icons in the info line at the top of the display screen indicate the current status of the handset. The two black areas in the bottom line of the display screen, labeled **LINE** and **MENU**, respectively, on the idle screen, indicate which functions or actions the context-sensitive function keys underneath the display will be able to access or execute. All other information (e.g., menus, messages, etc.) is shown in the text area; on the idle screen, the time and date are displayed in this area immediately above the function key line.

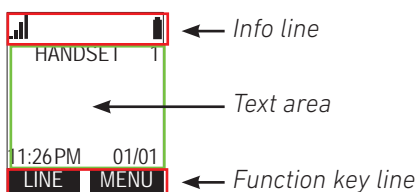

Icon	Status
	Indicating signal strength from one bar (weak) to four bars (strong). When the handset is out of range of the base station, the icon is not visible, and the "out of range" message appears in the text area of the display.
	Indicating battery strength from 1/3 to 3/3. The battery symbol flashes when the battery is empty or almost empty. For more information, see "Battery charging status" on page 17.
	The symbol appears to the right of the signal strength symbol when the ringer is off, i.e., when the ringer volume has been reduced to zero.
	When a headset is connected to the jack on the right side of the handset, the symbol appears to the left of the battery symbol when you dial a call and when you accept a ringing call, indicating that audio is delivered via the headset.
	Speakerphone is active after the speakerphone key was pressed, as indicated by the symbol to the left of the battery symbol.
	The symbol appears to the right of the signal strength symbol when the microphone has been muted by pressing .
	The symbol appears to the left of the battery symbol when "Call Forward All" has been set to "on" in the Features -> Call forward menu.
	The symbol appears to the left of the battery symbol when "do not disturb" has been set to "on" in the Features -> DND menu.

Display screen navigation

See "Navigation keys" on page 23.

Hard Keys

Context-sensitive function keys

The two keys underneath the display are context-sensitive function keys (soft keys) for executing the function currently available on that key, as indicated by the text in the label above the key.



- When the phone is idle, the available functions are **Line** and **Menu**.
- During calls or when you are editing settings, contacts etc., you will see the options available at that particular moment (hold, transfer, etc.).

Navigation keys

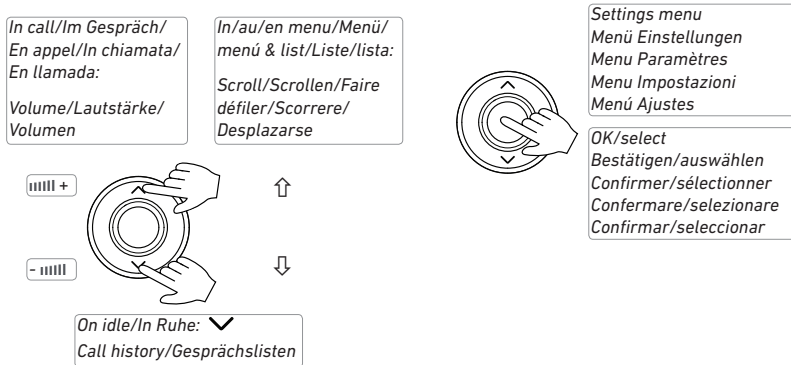

- Up and down arrows on the outer ring of the navigation key.
 - In a call: Adjusting the volume.
 - In menus and lists: Press the top and bottom arrow to navigate up and down, respectively, in menus and lists.
- Down arrow on idle screen: Press to open call history.
- Center button.
 - On idle screen: Press to open the main menu.
 - In menus and lists: Press to select highlighted item, i.e., open a submenu etc.

Dedicated function keys



	Transfer an active call. See "Transferring calls" on page 34.
	Start and end a three-way conference on the phone. See "Conference" on page 33.
	Put the active call on hold, and unhold a held call. See "Hold" on page 31
	Intercom. Press the key to call one of the other extensions registered at the base station. Intercom calls are not handled by the PBX but by the base station only. See "Making an intercom call" on page 30.
	Press the key top turn on speakerphone; the red LED of the key lights up and remains on for as long as speakerphone is turned on. Pressing the key a second time will turn off both speakerphone mode and the LED on the key.
	Redial previously dialed calls. The last-dialed call is presented first: press the up and down arrows on the navigation key to select another call.
	Muting and unmuting the microphone during an active call. The muted microphone is indicated by the symbol to the right of the signal strength indicator in the upper left corner of the display.

Call keys

	Press to dial number entered on keypad or selected from directories and call lists.
	Press to end calls and, in some contexts, exit or end actions.

Alphanumeric keys



These keys are used to enter numerals and letters and to dial speed dial numbers.

- **Deleting characters while editing.** Press the function key underneath **BACKSP** to delete the character to the left of the cursor.
- **Numeral mode.** When dialing or adding/editing numbers in your local directory, the numerals 1-9 and 0 and the asterisk * and the pound/hash # symbols will be accepted by the phone. Pausing between the characters is not necessary.
- **Letter modes.** When adding or editing names in your local directory, pause briefly after each character until the cursor has moved forward. Select one of three letter modes by pressing ; the current input mode is indicated by the letters Abc, abc, or ABC in the info line on the display.



Abc: The first letter of each word/name is upper case, the rest are lower case.

abc: All letters are lower case.

ABC: All letters are upper case.

In any of the letter modes:

- Press the key once to enter the first letter printed on the key, twice to enter the second letter, etc. Keep pressing the key to enter the number printed on the key and any available letters with accents and umlauts. Examples:
 - In lower case mode, pressing one to four times will type the characters **a, b, c,** and **2**. Pressing it five times will type **ä**, six times types **æ**, seven times types **à**, etc.
 - In upper case mode, pressing one to four times will type the characters **A, B, C,** and **2**. Pressing it five times will type **Ä**, six times types **Æ**, seven times types **À**, etc.
- Press to enter a space.
- **Speed dialing.** Keys 1 - 0 can also be used to speed dial numbers. When the key is long-pressed (for at least one second), the handset starts dialing the number specified for that key in the speed dial menu. For information on setting speed dial numbers, see "Speed dial" on page 44.

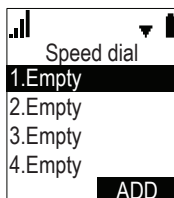

Using the phone

To be able to use the M-series DECT phones, the base station must be connected to your network's or your VoIP service provider's PBX, and the handset(s) must be registered at the base station. The base station follows most Snom configuration and management schemes. It is recommended to have a local HTTP/HTTPS server for firmware updates, central configuration management, and hosting firmware files for base stations, handsets, and repeaters. Handsets are updated over the air by the base station.

Note: The default PIN for deregistering the handset from the base station is 0000. It can be changed in the admin settings of the handset for all handsets registered at the base station. If the PIN has been changed, you will also be prompted to enter it when registering the handset.

Registering the handset to the base station

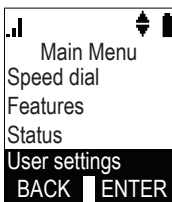

To be able to make and receive calls on the handset, it must be registered at the base station, and an account must have been configured for it on the base station. Make sure that the handset has a charged battery before proceeding.

1. Press **Menu** or  on the handset. The **Main Menu** appears.





2. Press **▼** to scroll to **User settings** and press **Enter** or .



3. Press **▼** to scroll to **Registration** and press **Enter** or .
4. With **Handset** highlighted, press **Select** or . You will see a succession of prompts on the display, beginning with:
 - a. "Which device do you want to register the handset to?" Press **Base**. You will be prompted to:



- b. Press the locator button  on the base station for four seconds, then release it and press **Next** on the handset. The power  and SIP  LEDs on the base station begin to flash. You will then be prompted to:

- c. "Then, press the # key at the handset." Press  on the handset.



The display shows "Registering... Please wait". The registration will take approximately 10 seconds. If the registration has been successful, you will hear a beep and briefly see the message "Handset Registered". The display will then show HANDSET 1.

Note: If the handset fails to register, place it in the charger for a few seconds, remove it, and repeat the registration procedure.



Changing the name of the handset

The default name of the handset is HANDSET 1, HANDSET 2, etc. You can customize the name shown on the display, for example to your name or your extension number.



1. Press **Menu** or  on the handset. The **Main Menu** appears.
2. Press **▼** to scroll to **User settings** and press **Enter** or .
3. Press **▼** to scroll to **Phone Rename** and press **Enter** or .



4. On the **Phone Rename** screen, press  to switch the input mode, whenever necessary, from lower to upper case letters to numerals. The current input mode is indicated by "Abc", "ABC", and "123", respectively, at the top center of the display screen. To delete the character to the left of the cursor, press **Backsp**.
5. When you have finished editing, press **Set** to save.

Deregistering the handset from the base station

The handset can only be registered at one base station at a time. To be able to use it with a different one, you must deregister it from its current base station first.



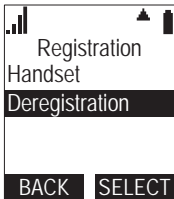

1. Press **Menu** or  on the handset. The **Main Menu** appears.
2. Press **▼** to scroll to **User settings** and press **Enter** or .
3. Press **▼** to scroll to **Registration** and press **Enter** or .

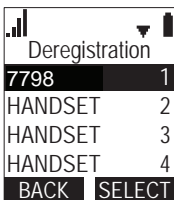

4. Press **▼** to highlight **Deregistration** and press **SELECT** or . The list of registered handsets is displayed.



Note: If your handset has a name (your name or your extension number, for example), it will be listed instead of "HANDSET".

5. Highlight the handset you want to deregister and press **SELECT** or . The display will prompt you to enter the handset's PIN. Before you do that,
6. press the locator button  on the base station for four seconds and release it. The power  and SIP  LEDs on the base station begin to flash.
7. Enter the handset's PIN (the default PIN is 0000) and press **OK** or . The deregistration will take approximately 10 seconds. When it has been completed, you will hear a beep and see the message "Handset Deregistered."

Note: The handset enters an energy-saving charging mode after being deregistered. All cordless telephone functions except handset-battery charging are disabled. Energy-saving charging mode is deactivated after the handset registers to the base station.

Locating the handset

Press the locator button  on the base station briefly to page all handsets registered at the base station. The handsets registered at the base station will ring and show the "Paging" message for 60 seconds, unless turned off.

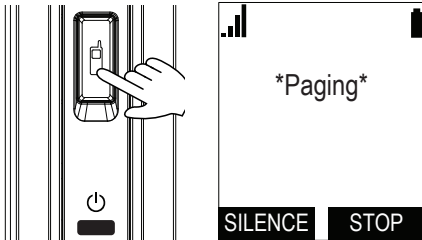

- Press  again or press **STOP** on one of the handsets to stop paging all handsets. Placing one of the handsets in the charger will also stop paging of all handsets.
- On each individual handset, press **SILENCE** to turn off the ringer for that handset.

Making calls

See "Entering numerals, letters, special characters, and symbols" on page 25 for information on input modes and entering letters, numerals, and special characters. To end any call, press **END** (Fig. 3) or  or put the handset in the charger.

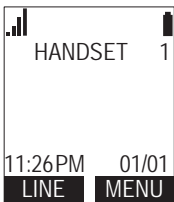

Fig. 1

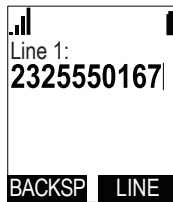

Fig. 2

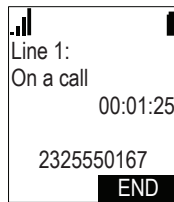

Fig. 3 - in call

Selecting identity for current outgoing call

If the handset is authorized to use more than one account for outgoing calls, you can select a different account than the primary one assigned to the handset for making the next outgoing call.

1. On the idle screen (Fig. 1), press **LINE**.
2. On the **Dialing Line** screen, scroll with **▲** / **▼** to highlight a line.
3. Press **SELECT**. The screen shows the outgoing identity underneath the signal strength indicator (Fig. 2).
4. Enter the number to be dialed on the keypad.
5. Press **DIAL**. The number will be dialed automatically if you haven't entered a digit for more than two seconds and if the phone has identified the number as valid.



Note: You can also enter the number first and then select another outgoing identity by pressing **LINE** (Fig. 2).

Using a wired headset

When a wired headset is plugged into the headset jack, audio input and output will automatically be transferred to the headset. The headphone symbol  is displayed in the info line to the left of the battery symbol.



Note: When speakerphone mode is turned on by pressing , audio via the headset is turned off for as long as speakerphone is on.

Using speakerphone

During an active call, press  to turn on speakerphone. The red LED on the key lights up, and the speakerphone symbol  is displayed in the info line to the left of the battery symbol.



Using different dialing methods

Dialing manually







1. From the idle screen, enter the number on the keypad.
2. Press  to dial. Alternatively, press  to dial if you want to use speakerphone for the call.

Note: You can also press  at any time during an active call to continue on speakerphone.



Redialing



1. Press  to show the last number dialed.
2. Press  to show numbers dialed earlier.
3. Press **DIAL** or  to dial the number on the display.

Calling number from call history (missed, received, dialed calls)

1. Press **MENU** or .
2. Press  to scroll to **Call history**, then press **ENTER** or  to open the menu.
3. The list of **Missed Calls** is highlighted. Press  to scroll if you want to view **Received Calls** or **Dialed Calls** instead.
4. Press **REVIEW** to view the latest call on the list. Scroll through the list with  / .
5. Press **DIAL** or  to dial the number on the display.

Calling number from phone directory

1. Press **MENU** or .
2. Press  to scroll to **Directory**, then press **ENTER** or  to open the directory menu.
 - The **Local directory** contains the contacts available only on your handset.
 - The **Base directory** contains the contacts stored on the base station and available to all handsets registered at the base station.
 - If **LDAP** is available, it can also be selected from the menu.

3. Press ▼ to scroll to a directory, if necessary, then press **REVIEW** or  to open it.
4. Scroll through the list with ▲ / ▼; in the case of LDAP, select whether you want to search for the first or last name and press **SELECT**, enter the first letter(s) of the name and press **SEARCH**.
5. Press **DIAL** or  to dial the number on the display.

Speed dialing

Press the number key assigned to the speed dial number for two seconds to dial the number.

Making an intercom call

You can call the other handsets registered at the base station without the call going to the PBX.

1. Press .
2. In the Intercom menu (Fig. 1), select one of the available handsets and press **SELECT**.

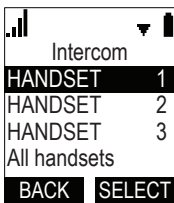

Fig. 1

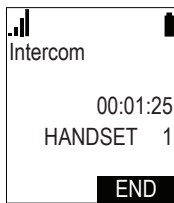

Fig. 2

3. To end the call (Fig. 2), press **END** or  or put the handset in the charger.

Accepting calls

Incoming calls are announced by the ringer, unless it has been turned off in **User Settings -> Ringers -> Ringer volume**, and by the "Incoming call" message on the display. To end calls (Fig. 2), press  or **END** or put the handset in the charger.



Fig. 1

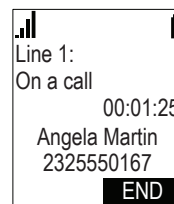





Fig. 2

- To accept an incoming call, press  or **ANSWER**.
- To accept an incoming call on speakerphone, press .
- To reject an incoming call, press **REJECT**.
- Intercom calls from other handsets registered at the base station cannot be rejected. You can turn off the ringer for the call by pressing **SILENCE**.

Call Waiting

As the default setting, a second incoming call is announced by beeps at 5-second intervals and by the "Call waiting" message on the display. Press  or **ANSWER** to accept the call waiting and to simultaneously put your current call on hold.

Note: If you want to forward calls when your phone is busy, press **REJECT** to send the call waiting to the "busy" forwarding number.

Turning call waiting off: See "Call waiting" on page 45.

Active calls

Each handset can manage two concurrent calls, one active, one on hold; or both calls on hold, or both calls in conference with you.

Hold

You can hold up to two external calls. Intercom calls cannot be put on hold.

Putting a call on hold

- Press **||** to put the current call on hold.

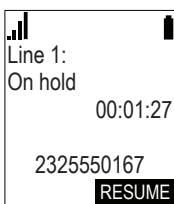

- Your current call will be put on hold automatically when you press  or **ANSWER** to accept a second incoming call (see "Call Waiting", above).

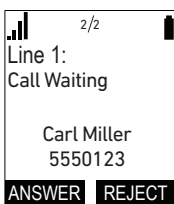

Note: If the other party puts you on hold, you may see the message "Held by far end". Press **END** to end the call. This function depends on whether it is provided by your service provider and on the compatibility of the PBXs and the phones on both ends.

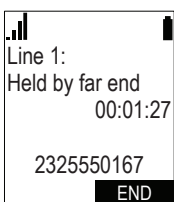

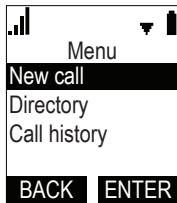

Making a call with a call on hold

1. Press .

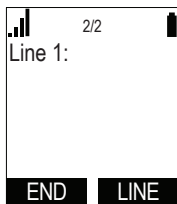

2. With **New call** highlighted, press **ENTER** or .



3. Enter the number to be dialed on the keypad and press **DIAL** or .

Connecting the active call to the call on hold

1. Press . The held call appears onscreen.



2. Press **SELECT**. The call is transferred immediately.

Switching between two calls

Press **NEXT** to switch between viewing the active call (Fig. 1) and the call on hold (Fig. 2).

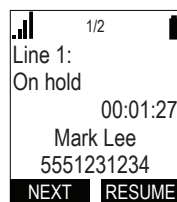
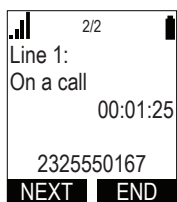

Fig. 1

Fig. 2

- When viewing the held call (Fig. 2), press **RESUME** to talk to the held caller and put the other call on hold; or
- press **NEXT** to return to viewing the active call.
- When viewing the active call, press **END** to end the call.



Conference

The maximum number of participants is three (your phone and two others) for phone-based conferences.

Note: For information and instructions on server-based conferences hosted by your service provider or by your network, if provided, please ask your service provider and/or your IT administrator.

- When in an active call, press . The active call is automatically put on hold, and the **Conference** screen appears.



- Select **A handset party** if you want to transfer the call to another handset registered at the same base station.
 - Select **A new party** if you want to transfer the call to any other number.
- With your selection highlighted, press **SELECT**.
 - Dialing the third party:
 - If you selected **A handset party**, you will see the **Intercom** screen. Select a handset from the list and press **SELECT** or  to dial.
 - If you selected **A new party**, you will see the message "Conference with" on the display. Enter the number you want to transfer the call to or press  to select a number from the directory or a call list. The label **DIAL** appears on the screen. Press **DIAL** or  to dial.

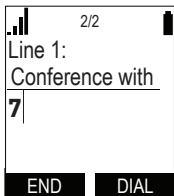

- With the new party on the line, press  to start the conference with the call on hold.

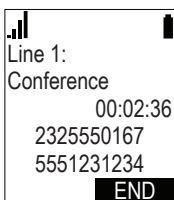

- Press **END** to end the conference call and the connections to both parties.

Starting a conference with a held call

- If you have an active call and a call on hold and want to start a conference with them, press . The "Conference with" screen with the held call(s) appears.

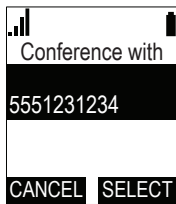

- Press **SELECT** to start the conference with the active call and the highlighted held call.

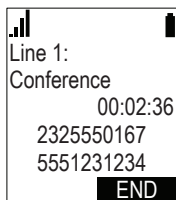

- Press **END** to end the conference call and the connections to both parties.

Transferring calls

When you have a call on the line, there are two ways to transfer it to a third party:

- Announcing the call to the third party first, to make sure the call is welcome and will be accepted: **Attended transfer**.
You can also transfer the active call to a held call.
- Transferring the call unannounced: **Blind transfer**. There will be no feedback on whether the third party is available and/or picking up the call.

Note: Blind transfers to other handsets registered at your base station are not possible.

Attended transfer



- Press . The call is automatically put on hold, and the **Transfer to** screen appears.



Fig. 1

- Select **A handset party** if you want to transfer the call to another handset registered at the same base station.
 - Select **A new party** if you want to transfer the call to any other number.
- With your selection highlighted, press **SELECT**.
 - Dialing the third party:
 - If you selected **A handset party**, you will see the **Intercom** screen. Select a handset from the list and press **SELECT** or  to dial.

- If you selected **A new party**, you will see the message "Transfer to" on the display (Fig. 2). Enter the number you want to transfer the call to; the label **DIAL** appears on the screen (Fig. 3). Press **DIAL** or  to dial.

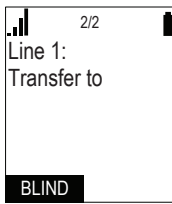

Fig. 2

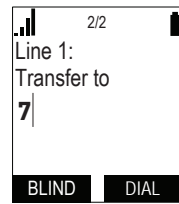

Fig. 3

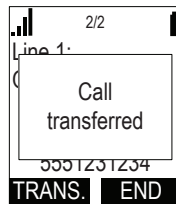



Fig. 4

4. When the third party answers, announce the call.
5. If the third party wants to accept the call, press  or **TRANS**. When the call has been transferred, you will see the "call transferred" message (Fig. 4, above).

Transferring an active call to a held call

1. With a call on hold and a call on the line, press . The **Transfer to** screen showing the held call appears on the display.



2. Press **SELECT**. The call is transferred immediately.

Blind transfer

1. Press . The call is automatically put on hold, and the **Transfer to** screen appears.



2. With **A new party** highlighted, press **SELECT**.

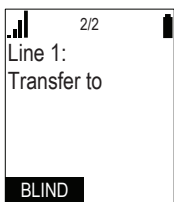

3. Press **BLIND**.

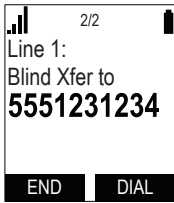

4. Enter the number you want to transfer the call to and press **DIAL** or to dial.
5. When the call has been transferred, you will see the "call transferred" message (Fig. 3, above). **Note:** This does not mean that the third party has answered the call, merely that it is now ringing there.

Ending calls

To end calls, press or **END** or put the handset in the charger.

Listening to messages

When there is a new message, the message LED blinks and the "New Messages" notification is displayed on the idle screen.



Fig. 1



Fig. 2

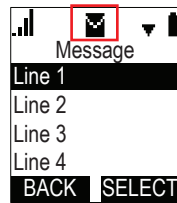

Fig. 3

1. Open the **Main Menu** and press **ENTER** or (Fig. 2). The **Message** menu appears.
2. If necessary, scroll to your line (account/handset). If there is a new message for the highlighted line (account/handset), a checkmark appears at the top of the display (Fig. 3).
3. Press **SELECT**.
4. Depending on the mailbox setup in your network or provided by your service provider you may now have to enter a code or follow voice prompts. Please check with your IT administrator or service provider.

Call history

Three call lists of missed, dialed, and received calls are stored on the phone. They contain the number and the time and date of the calls. If the memory allotted to storing the call lists is full, the oldest ones will be overwritten.

1. In the **Main Menu** of the handset, scroll to "Call history" and press or **ENTER**.



Fig. 1

Note 1: When the phone is idle, you can access call history directly by pressing the down arrow ▼ on the navigation key.

Note 2: You can view the list of dialed calls directly by pressing the redial key .

- If necessary, scroll to the list you want to view and press **REVIEW** or  (Fig. 1). The phone number of the latest call on the list is shown with the date and time of the call, an icon indicating the type of call, and the number of entries on the list, e.g., 1/5 (the first of a total of five) in Fig. 2.



	Received calls
	Dialed calls
	Missed calls



Fig. 2

Calling a number on a call list

- Open the list and press ▲ or ▼ to scroll through the entries.
- Press **DIAL** or  to dial the number on the display.

Note: You can edit the number before dialing.





- With the entry on the display, press .



Fig. 3

- On the "Edit dial" screen (Fig. 3), press  or **SELECT**.
- Edit the number and press .

Saving a number to the directory

- With the call history entry on the display, press .
- Scroll to "Save" (Fig. 3, above) and press  or **SELECT**.
- Select the directory you want to save the entry to and press **ENTER**. The phone number is entered as both first name and work number.
- Edit the new directory entry as necessary. See "Adding a contact to local directory, base directory, blacklist" on page 41 for more information.
- Press **SAVE** to save and return to the call.

Deleting an entry from the list

When viewing a call, press **DELETE**.



Deleting a call list

1. In the "Call history" menu (Fig. 1 on page 36), select the list you want to delete.
2. Press **DEL ALL**.
3. Confirm by pressing **YES** on the "Delete all entries in Received Calls?" screen.

Rejecting or redirecting incoming calls

Rejecting anonymous calls

Calls without caller ID information will be rejected; the handset will not ring. The default setting for all lines/accounts is off. Changing the setting:

1. Press **MENU** or .
2. Scroll **▼** to "Features" and press **ENTER** or .
3. Scroll **▼** to "Block anonymous" and press **ENTER** or .

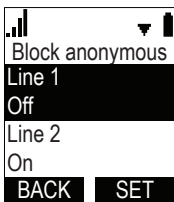

4. Scroll **▼** to each line/account whose setting you want to change. With the line/account and its current setting (off or on) highlighted, press .
5. Press **SET** to save and return to the "Features" menu.

Do not disturb (DND)

Incoming calls will not ring on the phone; callers hear the busy signal.

1. Press **MENU** or .
2. Scroll **▼** to "Features" and press **ENTER** or .
3. With "DND" highlighted, press **ENTER** or .
4. Scroll **▼** to each line/account whose setting you want to change. With the line/account and its current setting (off or on) highlighted, press .
5. Press **SET** to save and return to the "Features" menu.

Call forwarding

The phone can be set to forward incoming calls, either always or when busy or when the phone is not answered. When call forwarding is on, the symbol  is displayed on the idle screen (Fig. 1).

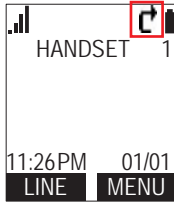

Fig. 1

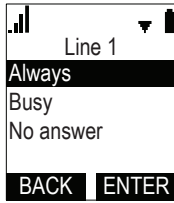









Fig. 2



Fig. 3

1. Press **MENU** or .
2. Scroll ▼ to "Features" and press **ENTER** or .
3. Scroll ▼ to "Call forward" and press **ENTER** or .
4. Scroll ▼ to the line/account whose setting you want to change. With the line/account and its current setting (off or on) highlighted, press .
5. Select the forwarding condition (Fig. 2).
6. Press  to change the setting from off to on and vice versa (Fig. 3).
7. If a phone number has not been set or if you want to change it, scroll ▼ down to it and enter or edit the number.
 - If you had selected the conditions "always" and "busy", skip step 8 and continue with step 9.
 - If you had selected the condition "no answer", continue with step 8.
8. If you had selected the condition "no answer", scroll ▼ down to "No ans. delay". The default is six rings before the call will be forwarded. The available settings are 1 to 10 rings. Press  to increase the rings one at a time until 10 and then back to 1.
9. Press **SET** or  to save and return to the "Features" menu.

Note: If you have turned on call forwarding on busy and call waiting is also on, press **REJECT** to send the call waiting to the "busy" forwarding number.

Directories

The phone has three contact lists; it can also provide access to external directories like LDAP. To open the directory, scroll down to "Directory" in the Main Menu of the handset and press  or **ENTER**.



- Contact lists.
 - The **Local directory** contains the contacts available only on one handset. It can be edited only from that handset.
 - The **Base directory** contains the contacts stored on the base station and available to all handsets registered at the base station. It can be edited on the base station and all handsets registered at the base station.
 - The **Blacklist** (deny list) is also stored on the base station and contains the contacts that are blocked from ringing on the phone; callers hear the busy signal. It can be edited on the base station and all handsets registered at the base station.
- LDAP. If available and enabled on the base station, **LDAP** is shown in the **Directory** menu. LDAP cannot be edited on the base station or any of the handsets. The LDAP directory is provided by your network, your VoIP provider, or another external source. The necessary settings for access to it are made on the base station.

Local directory, base directory, blacklist

Calling a number from the directory





Fig. 1

Fig. 2

Fig. 3

Method 1

1. In the **Main Menu** of the handset, scroll to "Directory" and press  or **ENTER**.
2. Select the directory and press **REVIEW** or  (Fig. 1).
3. Scroll through the contacts by pressing **▲** or **▼** on the navigation key.
4. If the contact has more than one phone number (work, mobile, other), press **TYPE** until you see the one you want to dial (Fig. 2).
5. Press **DIAL** to call the number.

Method 2

1. In the **Main Menu** of the handset, scroll to "Directory" and press  or **ENTER**.
2. Select the directory and press **OPTION** (Fig. 1).
3. With "Search" highlighted, press **SELECT** (Fig. 3).
4. Enter the first letter(s) of the contact's name and press **SEARCH**.
5. If the contact has more than one phone number (work, mobile, other), press **TYPE** until you see the one you want to dial (Fig. 2).

Adding a contact to local directory, base directory, blacklist







1. In the **Main Menu** of the handset, scroll to "Directory" and press  or **ENTER**.
2. Select the directory and press **OPTION** (Fig. 1).
3. Scroll to "Add new" and press **SELECT** (Fig. 3).



Fig. 4

4. As a minimum, you must add either a first or last name and a phone number before you can save the contact. The available settings are:
 - First name
 - Last Name
 - Work
 - Mobile
 - Other
 - Ringer tone. "Auto" is the default, i.e., the ringer setting on your handset. Press  if you want to select any of the other melodies available on the handset.
 - Dial line. The default is the "line" (identity, account) of your handset. Press  if you want to select any of the other accounts assigned to the handset on the base station.
5. When you have entered the data, press **SAVE** (Fig. 4).

Editing an entry in local directory, base directory, blacklist

1. In the **Main Menu** of the handset, scroll to "Directory" and press  or **ENTER**.
2. Select the directory and press  or **REVIEW** (Fig. 1).
3. Scroll through the contacts by pressing **▲** or **▼** on the navigation key. When the contact you want to edit is onscreen, press .

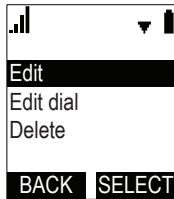

Fig. 5

4. With "Edit" Highlighted, press **SELECT** (Fig. 3).
5. Edit the data and press **SAVE** when you are done.

Deleting an entry from local directory, base directory, blacklist

1. In the **Main Menu** of the handset, scroll to "Directory" and press or **ENTER**.
2. Select the directory and press or **REVIEW** (Fig. 1).
3. Scroll through the contacts by pressing **▲** or **▼** on the navigation key. When the contact you want to delete is onscreen, press .
4. Scroll to "Delete" and press **SELECT** (Fig. 3).
5. On the "Delete" confirmation screen, press **YES**.

Deleting all entries in local directory, base directory, blacklist

1. In the **Main Menu** of the handset, scroll to "Directory" and press or **ENTER**.
2. Select the directory and press **OPTION** (Fig. 1).
3. Scroll to "Delete all" and press or **SELECT** (Fig. 3).
4. On the "Delete all entries in [directory/blacklist]" confirmation screen, press **YES**.

LDAP search

1. In the **Main Menu** of the handset, scroll to "Directory" and press or **ENTER**.
2. Scroll to "LDAP". When "LDAP" is highlighted, the label **SEARCH** appears at the bottom of the display screen.

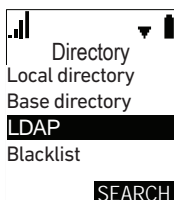



Fig. 6

3. Press or **SEARCH**.
4. On the "Search by" screen, select first or last name and press or **SELECT**.
5. Enter the first letter(s) of the contact you want to dial and press **SEARCH**.

Configuring the handset

All settings are accessed from the main menu. From the idle screen, press  or **MENU** to open it.

Menus

Main Menu	Submenus		
Message	Directory	Call history	
Directory	Local directory	Missed calls	
Call history	Base directory	Received calls	
Intercom	LDAP	Dialed calls	
Speed dial	Blacklist		
Features	Features	User settings	Admin settings
Status	DND	Language	Network settings
User settings	Call forward	Set date/time	Secure browsing
Admin settings	Block anonymous	NTP	Provisioning
	Dial as anonymous	Phone rename	Edit PIN code
	Lift HS answer	Contrast	Edit password
	Miss call alert	Ringers	Firmware update
	Call waiting	Low batt tone	
		Link lost tone	
		Key tone	
		Edit password	
		Registration	

Main menu

Items	Submenu	Description
Message		Accessing your voice messages if a mailbox is provided by your service provider or PBX. See "Listening to messages" on page 36.
Directory		Accessing the available directories. See "Directories" on page 40.
Call history		Accessing the lists of missed, received, and dialed call. See "Call history" on page 36.
Intercom		Making internal calls to the other extensions registered at the base station. See "Making an intercom call" on page 30.
Speed dial		See setting "Speed dial" on page 44.
Features		See submenu "Features" on page 44.
Status		Contains information on network and line settings and product info like firmware version, model, and serial number of handset and base station. See "Status" on page 46.
User settings		See submenu "User settings" on page 46.
Admin settings		See "Admin settings" on page 49.

Speed dial

Keys 1 - 0 can be used to speed dial ten numbers by long-pressing the respective key. Setting the speed dial numbers:

1. In the **Main Menu** of the handset, scroll to "Speed Dial" and press  or **ENTER**.

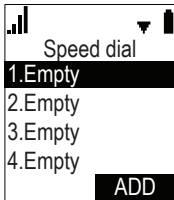

Fig. 1

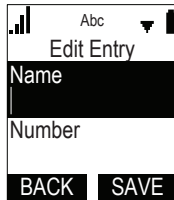

Fig. 2



2. Scroll to an "Empty" entry and press **ADD** (Fig. 1).
3. On the "edit entry" screen, enter a name and number (Fig. 2). If you want to assign a different outgoing number ("line") than your handset's, scroll further down and also enter a line.
4. Press **SAVE**.

Features

Features Menu	
Items	Description
DND (do not disturb)	When enabled, calls to the line/account/extension will not ring; the caller will hear the busy signal. Setting: See "Do not disturb (DND)" on page 38.
Call forward	Forwarding incoming calls: Always, when busy, or when the phone is not answered. See "Call forwarding" on page 39.
Block anonymous	See "Rejecting anonymous calls" on page 38.
Dial as anonymous	See "Hiding your caller ID" on page 44.
Lift HS answer	Answering calls by lifting the handset from the cradle. See "Answering calls by removing handset from charger" on page 45.
Miss call alert	Showing or hiding the total number of missed calls on the idle screen. See "Missed call alert" on page 45.
Call waiting	Turning call waiting off and on. The default setting is on. See "Call Waiting" on page 31.

Hiding your caller ID

The default setting is "off".

1. In the **Main Menu** of the handset, scroll to "Features" and press  or **ENTER**.
2. In the **Features** menu, scroll to "Dial as anonymous" and press  or **ENTER**.
3. Scroll to the line (account/identity) whose caller ID you want to hide and press . Its status changes to on.

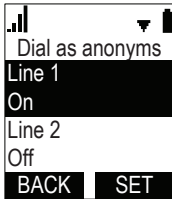



- Press **SET** to save and return to the "Features" menu.

Note: To turn caller ID for the account back on, follow the same instructions. Pressing  in step 3 when the status of caller ID for the line is "off" will change the status to "on".

Answering calls by removing handset from charger

The default setting is "off". If you want to be able to accept calls by lifting the handset from the charger:

- In the **Main Menu** of the handset, scroll to "Features" and press  or **ENTER**.
- In the **Features** menu, scroll to "Lift HS answer" and press  or **ENTER**.

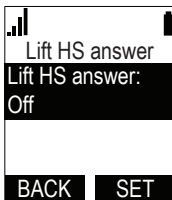



- Press . Its status changes to on.
- Press **SET** to save and return to the "Features" menu.

Note: To return to the default setting, follow the same instructions. Pressing  in step 3 when the status is "on" will change it to "off".

Missed call alert

The default setting is on; the "x missed calls" message (x is the total number of missed calls in the call history) is displayed on the idle screen unless you clear the missed call list. Changing the setting:

- In the **Main Menu** of the handset, scroll to "Features" and press  or **ENTER**.
- In the **Features** menu, scroll to "Miss call alert" and press  or **ENTER**.



- Scroll down to "Hide alert" and press  or **SET** to save and return to the "Features" menu.

Note: To turn the feature back on, scroll up to "Show alert" and press  or **SET** to save and return to the "Features" menu.

Call waiting

The default setting is on; a second incoming call is announced by beeps at 5-second intervals and by the "Call waiting" message on the display. See "Call Waiting" on page 31 on how to use this feature. Changing the setting:

1. In the **Main Menu** of the handset, scroll to "Features" and press or **ENTER**.
2. In the **Features** menu, scroll to "Call waiting" and press or **ENTER**.



3. Scroll down to "Hide alert" and press or **SET** to save and return to the "Features" menu.

Note: To turn the feature back on, scroll up to "Show alert" and press or **SET** to save and return to the "Features" menu.

Status

These submenus contain information you may need for troubleshooting.

- **Network.** Information on the LAN network your phone system is connected to.
- **Line.** Information on the registration status of your SIP account(s).
- **Product info.** Firmware version, model, and serial number of handset and base station.

1. In the **Main Menu** of the handset, scroll to "Status" and press or **ENTER**.

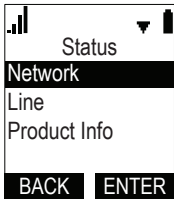



2. In the **Status** menu, highlight the submenu you want to view and press or **ENTER**.
3. Press **BACK** to return to previous screen.

User settings

Main Menu	
Items	Description
Language	The handset language. See "Language" on page 47.
Set date/time	Setting date and time and date and time formats. See "Date/time" on page 47.
NTP	Shows the NTP time server used by your system.
Phone rename	Displaying a different name on the screen instead of the default HANDSET. See "Changing the name of the handset" on page 26.
Contrast	Changing the level of the display's brightness. See "Contrast" on page 47.
Ringers	See "Ringtone and ringtone volume" on page 48.
Low batt tone	See "Info tones low battery, lost link, and key touch tones" on page 49.
Link lost tone	
Key tone	
Registration	Registering and deregistering the handset. See "Registering the handset to the base station" on page 25 and "Deregistering the handset from the base station" on page 27, respectively.

Language



1. In the **Main Menu** of the handset, scroll to "User settings" and press  or **ENTER**.
2. In the **User settings** menu, scroll to "Language" and press  or **ENTER**.





3. In the **Language** menu, highlight the language you want to use on the handset and press  or **SET** to save and return to the user settings menu.

Date/time

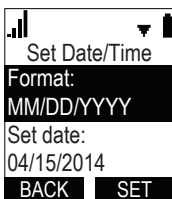

In this menu, you can set the date and time and the formats for displaying them on the handset. If your system uses a time server, setting the date and time should normally not be necessary. The default formats are DD/MM/YYYY (day/month/year) and 24-hour clock.

1. In the **Main Menu** of the handset, scroll to "User settings" and press  or **ENTER**.
2. In the **User settings** menu, scroll to "Set date/time" and press  or **ENTER**.
3. In the **Set Date/Time** menu, highlight the item you want to change or edit.



4. Settings.
 - Changing date or time format: Press  to change, then press **SET** to save and return to **Set Date/Time** menu.
 - Editing date or the time: Use the keypad to edit, then press **SET** to save and return to **Set Date/Time** menu.

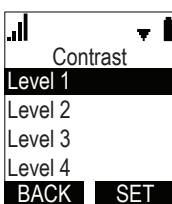

Contrast

1. In the **Main Menu** of the handset, scroll to "User settings" and press  or **ENTER**.
2. In the **User settings** menu, scroll to "Contrast" and press  or **ENTER**.



3. The default level is 4. If you want the display to be brighter, highlight a lower level; if you want the display to be darker, highlight a higher level.
4. Press **SET** to save and to return to the user settings menu.

Ringtone and ringtone volume

1. In the **Main Menu** of the handset, scroll to "User settings" and press  or **ENTER**.
2. In the **User settings** menu, scroll to "Ringers" and press  or **ENTER**.

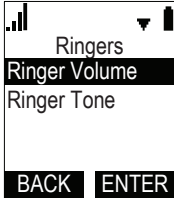

3. In the **Ringers** menu, highlight volume or tone and press  or **ENTER**.
4. Settings.
 - Volume:
 - a. Press \wedge on the navigation key to increase, press \vee to lower the volume.
 - b. Press **SET** to save and to return to the **Ringers** menu.

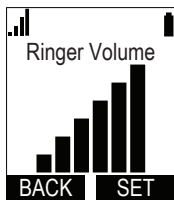



- Ringtone.
 - a. Select the line (account/identity) whose ringtone you want to change and press  or **ENTER**.
 - b. Select a melody. The highlighted melody is played.
 - c. Press **SET** to save and to return to the **Ringers** menu.

Info tones low battery, lost link, and key touch tones

The default for each setting is "on".

- Low battery tone. The battery is empty or has a very low charge.
- Lost link tone. The connection to the base station has been lost.
- Touch tones of keypad keys and function key **BACK**.

1. In the **Main Menu** of the handset, scroll to "User settings" and press  or **ENTER**.
2. In the **User settings** menu, scroll to the respective submenu "Low batt tone", "Link lost tone", or "Key tone" and press  or **ENTER**.

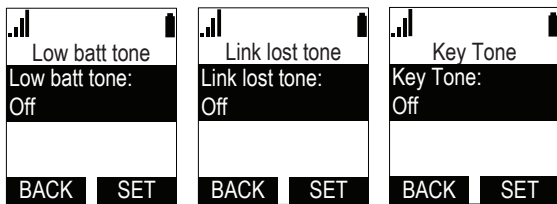

3. Press  to change the setting from on to off and vice versa.
4. Press **SET** to save and to return to the **User settings** menu.

Admin settings

The admin password is required every time you want to access this submenu. The default password is **admin**.

Main Menu	
Items	Description
Network settings	Select IPv4 or IPv6, if necessary
Secure browsing	Press  to change the setting from HTTP to HTTPS and vice versa. Changing this setting requires the rebooting of the base station to take effect.
Provisioning	Accessible after entering Login ID and Login PW to provisioning server. We recommend using the phone's web user interface (WUI).
Edit PIN code	The default PIN code for deregistering the handset from the base station is 0000 (4 x zero). To change it, follow the prompts on the display. If the PIN code has been changed, it will also need to be entered when the handset is registered at the base station.
Edit password	Editing user and admin passwords, following the prompts on the display. The defaults are: <ul style="list-style-type: none"> • User password: user • Admin password: admin
Firmware update	The phone will check whether there is an update. If there is, the update will start, if not, the update will be cancelled. Follow the prompts on the display.

Base station web user interface (WUI)

The base station has a web user interface (WUI). If you log on in admin mode, you have access to all settings. In user mode, you can view network status and registration information about your handset on the **System Status** and **Handset Status** pages, and you can configure the following features:

- Call settings
- User preferences
- Base directory
- Blacklist (deny list)
- User password





Your computer must be connected to the same network as your base station in order for you to use the WUI.

Default user names and passwords

- For using the device in admin mode.
User name: admin
Password: admin
- For using the device in user mode.
User name: user
Password: user

Finding the IP address of the base station

To access the base station's web user interface (WUI), you need its IP address. You can look it up on any handset registered at the base station (see "Registering the handset to the base station" on page 25).

1. Press  or **MENU** to open the "Main Menu" of the handset.
2. In the **Main Menu**, scroll to "Status" and press  or **ENTER**. In the **Status** menu, "Network" is highlighted.
3. Press press  or **ENTER**. In the **Network** menu, "IPv4" is highlighted.
4. Press press  or **ENTER**.

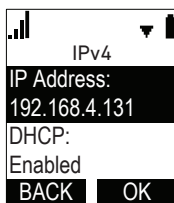

5. Make a note of the IP address. scroll to the respective submenu "Low batt tone", "Link lost tone", or "Key tone" and press  or **ENTER**.

Accessing the WUI

1. Open a web browser on your PC. Enter the IP address, preceded by "http://" in the address bar (for example: http://192.168.10.115) and press ENTER.

2. Enter your user name and password in the pop-up window:

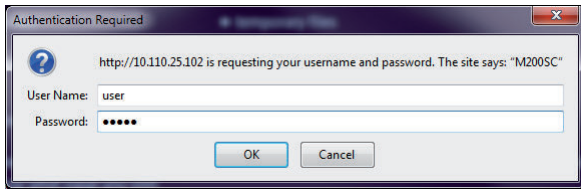

3. Click on **OK**.

WUI structure and handling

The WUI always opens on the **System Status** page.

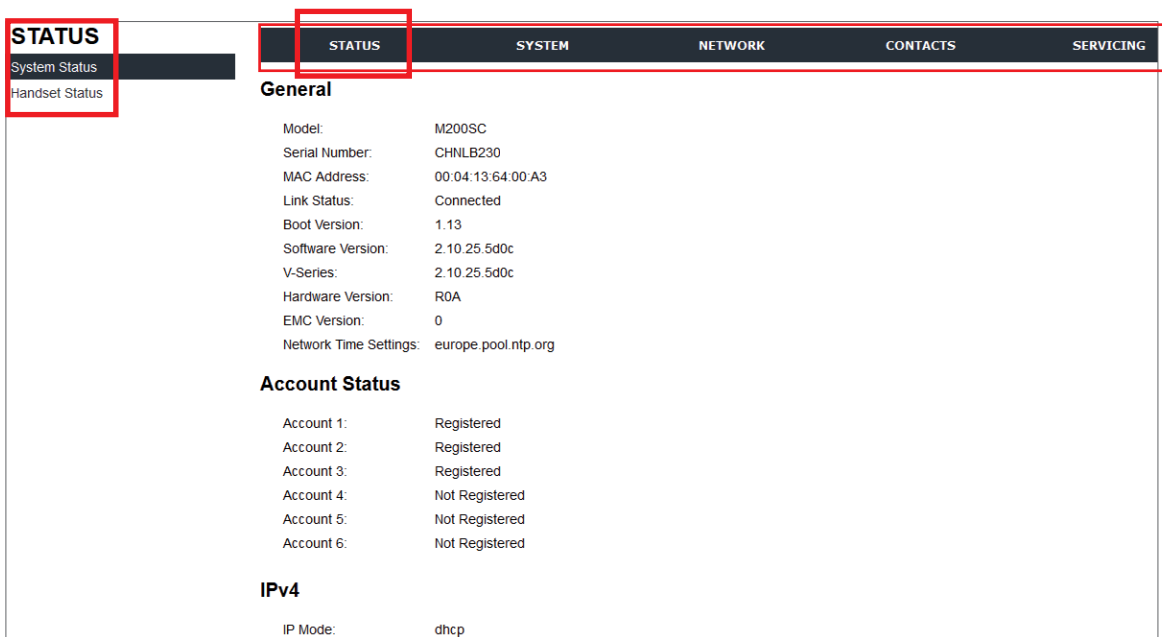

Fig. 1

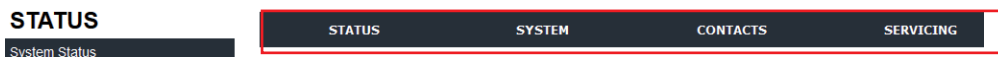

Fig. 2

The long black bar at the top of the window contains the main menu. The vertical menu in the left sidebar of the window shows the submenus of whatever main menu item you have clicked. Fig. 1 shows the WUI in admin mode; Fig. 2 shows the menu bar in user mode, i.e., the **Network** menu item is not visible.

1. Click on an item in the top bar to open the page for the top item in the vertical menu on the left side of the window.
2. Click on any other item in the sidebar to view that page.
3. When you have edited the settings on a page, always click on the **Save** button at the bottom of the page before opening another page or logging out.

Main menu

- **Status.** This menu has two pages, System Status and Handset Status, which contain information on your phone's hardware and software, SIP account registration, and network connection. Neither page has any settings that can be changed.

- **System.** In user mode, this page contains the call settings and the user preference for the accounts. In admin mode, the general account settings for setting up and registering the SIP accounts and the assignment of SIP accounts to individual handsets are also accessible.
- **Network.** In user mode, this menu item is not visible in the top bar. In admin mode, this menu has two pages, Basic and Advanced, where the network settings for IPv4 and IPv6, respectively, VLAN, VPN, etc. are configured.
- **Contacts.** This is a page where the base station's phone directory that is accessible to all registered handsets and the blacklist (deny list) are located and maintained. This is also where LDAP is configured.
- **Servicing.** This menu item contains numerous submenus with the time and date, language, and security settings, as well as the settings for firmware updates, provisioning, certificates, and TR069.

User settings

The settings available in user mode can also be configured on the handset assigned to the respective account.

System page

- **Call Settings.**

General Call Settings	Description
Anonymous Call Reject	Select to block incoming calls without caller ID.
Enable Anonymous Call	Select to make outgoing calls without your own caller ID information.

Do Not Disturb Setting	Description
Enable DND	Turning DND (do not disturb) on and off.

Call Forward Settings	Description
Enable Call Forward Always	Select to enable call forwarding for all calls on that account.
Enable Call Forward Busy	Select to enable call forwarding for calls when you are on another call on that account
Enable Call Forward No Answer	Select to enable call forwarding for unanswered calls on that account.
Target Number	Enter the number to which the calls will be forwarded.

- **User Preferences.** Select a language for the WUI from the drop-down menu. The default language is English.

Contacts page

- **Base Directory.** This is the base station directory available to all handsets registered at the base station.

Select All Sort By Last Name

Total: 6	First Name	Last Name	Ringer Tone	Work	Mobile	Other	Account	
<input type="checkbox"/>	7782		0	7782			2	Edit
<input type="checkbox"/>	Ava	Smith	0	159	7781		Default Account	Edit
<input type="checkbox"/>	Ava Smith		0	7781			2	Edit
<input type="checkbox"/>	John	Miller	0	159			2	Edit
<input type="checkbox"/>	Lila	Thomas	0	5558719			2	Edit
<input type="checkbox"/>	Sean	Simon	0	5687			2	Edit

First 1 Last

Delete Selected Entries Add New Entry
Clear Directory

Fig. 1

The base station directory can contain up to 10 pages with 20 entries on each, and a total of 200 altogether. If it has more than one page, the last line of the table of names shows which page you are viewing.



Viewing page 1

Fig. 2



Viewing page 2 of 2

Fig 3



Fig. 4

- Click **Next** to move to the next page.
- Click the number button to move to a previous page (Fig. 4).
- Click **Last** or **First** to move to the last or first page, respectively.
- When you are viewing the first or last page, the **First** (Fig. 2) or **Last** (Fig. 3) button, respectively, is replaced by text.
- Click on the **Select All** radio button to select all entries on the page.
- Click on the radio button of an entry to select that entry.
- Click **Sort By Last Name** or **Sort By First Name** to change the parameter for sorting the entire directory.
- Click **Add new entry** to create a new entry.

Create Local Directory Entry

First Name:

Last Name:

Ringer Tone:

Account:

Work Number:

Mobile Number:

Other Number:

Note 1: As a minimum, each entry must contain one name (first or last) and one phone number.

Note 2: Write phone and extension numbers as they need to be dialed by the phone. Don't add spaces, hyphens, dashes, etc.

Note 3: The ringtone selected for the entry will be played by the handset when a call from the contact is ringing.

- Click **Edit** to edit the entry on its own page.

Edit Local Directory Entry

First Name:

Last Name:

Ringer Tone:

Account:

Work Number:

Mobile Number:

Other Number:

- Click **Delete Selected Entries** to delete all entries whose radio button has a checkmark .
- Click **Clear Directory** to delete the entire directory.

- **Blacklist (deny list).** This directory contains the phone numbers of contacts whose calls you don't want to ring on the phone. It looks like and is managed the same way as the base station directory.

Blacklist

Select All Sort By Last Name

Total: 1	First Name	Last Name	Work	Mobile	Other	Account	
<input type="checkbox"/>		Blackbeard	5552013			1	Edit
First	1	Last					

Delete Selected Entries Add New Entry
Clear Blacklist

Create Blacklist Entry

First Name:

Last Name:

Account:

Work Number:

Mobile Number:

Other Number:

Save

Edit Blacklist Entry

First Name:

Last Name:

Account:

Work Number:

Mobile Number:

Other Number:

Save

Servicing page

In user mode, you can change the user password for the WUI on the **Security** page.

Passwords

User Password

Enter Old Password:

Enter New Password:

Re-enter New Password:

Admin settings

- **Status.** This menu has two pages, **System Status** and **Handset Status**. Neither page has any settings that can be changed.
 - **System Status.** View information on the base station's hardware and software, the registration status of the six accounts, and the network connection.
 - **Handset Status.** View name and registration status of the six possible handsets.
- **System.** In admin mode, this page contains the general account settings for setting up and registering the SIP accounts, the call settings, and the user preference for the accounts. The pages for assigning SIP accounts to and customizing the names of handsets are also accessible.
- **Network.** This menu, which is accessible in admin mode only, has two pages, Basic and Advanced, where the network settings for IPv4 and IPv6, respectively, VLAN, VPN, etc. are configured.
- **Contacts.** This is a page where the base station's phone directory that is accessible to all registered handsets and the blacklist (deny list) are located and maintained. This is also where LDAP is configured.
- **Servicing.** This menu item contains numerous submenus with the time and date, language, and security settings, as well as the settings for firmware updates, provisioning, certificates, and TR069.

See "Appendix 1 - Base Station Settings" on page 55 for a list of all settings.

Appendix 1 - Base Station Settings

User Settings

See "User settings" on page 52.

Admin settings

- **Status.** This menu has two pages, **System Status** and **Handset Status**. Neither page has any settings that can be changed.
 - **System Status.** View information on the base station's hardware and software, the registration status of the six accounts, and network connection.
 - **Handset Status.** View name and registration status of the six possible handsets.
- **System.** In admin mode, this page contains the general account settings for setting up and registering the SIP accounts, the call settings, and the user preference for the accounts. The pages for assigning SIP accounts to and customizing the names of handsets are also accessible.
- **Network.** This menu, which is accessible in admin mode only, has two pages, Basic and Advanced, where the network settings for IPv4 and IPv6, respectively, VLAN, VPN, etc. are configured.
- **Contacts.** This is a page where the base station's phone directory that is accessible to all registered handsets and the blacklist (deny list) are located and maintained. This is also where LDAP is configured.
- **Servicing.** This menu item contains numerous submenus with the time and date, language, and security settings, as well as the settings for firmware updates, provisioning, certificates, and TR069.

System

System Account Management

Each account (1 to 6) has its own page. Click on the account to open it.

General Account Settings	Description
Enable Account	Enable or disable the SIP account. Select to enable.
Account Label	Enter the name that will appear on the phone display when account x is selected. The Account Label identifies the SIP account throughout the WebUI and on the handset Dialing Line menu.
Display Name	Enter the Display Name. The Display Name is the text portion of the caller ID that is displayed for outgoing calls using account x.
User identifier	Enter the User identifier supplied by your service provider. The User ID, also known as the Account ID, is a SIP URI field used for SIP registration. Do not enter the host name (e.g. "@sipservice.com"). The WebUI automatically adds the default host name.
Authentication name	If authentication is enabled on the server, enter the authentication name (or authentication ID) for authentication with the server.
Authentication password	If authentication is enabled on the server, enter the authentication password for authentication with the server.
Dial Plan	Enter the dial plan, with dialing strings separated by a symbol.
Inter Digit Timeout (secs)	Sets how long the phone waits after any "P" (pause) in the dial string or in the dial plan.

Maximum Number of Calls	Select the maximum number of concurrent active calls allowed for that account.
Feature Synchronization	Enables the phone to synchronize with Broadworks Application Server. Changes to features such as DND, Call Forward All, Call Forward No Answer, and Call Forward Busy on the server side will also update the settings on the handset menu and WebUI. Similarly, changes made using the handset or WebUI will update the settings on the server.
DTMF method	Select the default DTMF transmission method. You may need to adjust this if call quality problems are triggering unwanted DTMF tones or you have problems sending DTMF tones in general.
Unregister after reboot	Enables the phone to unregister the account(s) after rebooting-before the account(s) register again as the phone starts up. If other phones that share the same account(s) unregister unexpectedly in tandem with the rebooting phone, disable this setting.

SIP Server Settings	Description
Server address	Enter the IP address or domain name for the SIP server.
Server port	Enter the port number that the SIP server will use.

Registration Settings	Description
Server address	Enter the IP address or domain name for the registrar server.
Server port	Enter the port number that the registrar server will use.
Expiration	Enter the desired registration expiry time in seconds.
Registration Freq (secs)	Enter the desired registration retry frequency in seconds. If registration using the Primary Outbound Proxy fails, the Registration Freq setting determines the number of seconds before a registration attempt is made using the Backup Outbound Proxy.

Outbound Proxy Settings	Description
Server address	Enter the IP address or domain name for the proxy server.
Server port	Enter the port number that the proxy server will use.
Backup Outbound Proxy Settings	
Server address	Enter the IP address or domain name for the backup proxy server.
Server port	Enter the port number that the backup proxy server will use.

Audio Settings	Description
Codec priority 1	Select the codec to be used first during a call.
Codec priority 2	Select the codec to be used second during a call if the previous codec fails.
Codec priority 3	Select the codec to be used third during a call if the previous codec fails.
Codec priority 4	Select the codec to be used fourth during a call if the previous codec fails.
Codec priority 5	Select the codec to be used fifth during a call if the previous codec fails.
Enable voice encryption (SRTP)	Select to enable secure RTP for voice packets.
Enable G.729 Annex B	When G.729a/b is enabled, select to enable G.729 Annex B, with voice activity detection (VAD) and bandwidth-conserving silence suppression.
Preferred Packetization Time (ms)	Select the packetization interval time.

Quality of Service Settings	Description
DSCP (voice)	Enter the Differentiated Services Code Point (DSCP) value from the Quality of Service setting on your router or switch.
DSCP (signalling)	Enter the Differentiated Services Code Point (DSCP) value from the Quality of Service setting on your router or switch.

Signaling Settings	Description
Local SIP port	Enter the local SIP port.
Transport	<p>Select the SIP transport protocol:</p> <p>TCP (Transmission Control Protocol) is the most reliable protocol and includes error checking and delivery validation.</p> <p>UDP (User Datagram Protocol) is generally less prone to latency, but SIP data may be subject to network congestion.</p> <p>TLS (Transport Layer Security)—the phone supports secured SIP signalling via TLS. Optional server authentication is supported via user-uploaded certificates. TLS certificates are uploaded using the configuration file.</p>

Feature Access Code Settings	Description
Voicemail	Enter the voicemail access code. The code is dialed when the user selects a line from the Message menu.
DND ON	Enter the Do Not Disturb ON access code.
DND OFF	Enter the Do Not Disturb OFF access code.
Call Forward All ON	Enter the Call Forward All ON access code.
Call Forward All OFF	Enter the Call Forward All OFF access code.
Call Forward No Answer ON	Enter the Call Forward No Answer ON access code.
Call Forward No Answer OFF	Enter the Call Forward No Answer OFF access code.
Call Forward Busy ON	Enter the Call Forward Busy ON access code.
Call Forward Busy OFF	Enter the Call Forward Busy OFF access code.
Anonymous Call Reject ON	Enter the Anonymous Call Reject ON access code.
Anonymous Call Reject OFF	Enter the Anonymous Call Reject OFF access code.
Anonymous Call ON	Enter the Anonymous Call ON access code.
Anonymous Call OFF	Enter the Anonymous Call OFF access code.

Voicemail Settings	Description
Enable MWI Subscription	When enabled, the account subscribes to the "message summary" event package. The account may use the User ID or the service provider's "Mailbox ID".
Mailbox ID	Enter the URI for the mailbox ID. The phone uses this URI for the MWI subscription. If left blank, the User ID is used for the MWI subscription.
MWI subscription expiration	Enter the MWI subscription expiry time (in seconds) for account x.
Ignore unsolicited MWI	<p>When selected, unsolicited MWI notifications—notifications in addition to, or instead of SUBSCRIBE and NOTIFY methods—are ignored for account x. If the phone receives unsolicited MWI notifications, the Message Waiting LED will not light to indicate new messages. Disable this setting if:</p> <p>MWI service does not involve a subscription to a voicemail server. That is, the server supports unsolicited MWI notifications.</p> <p>you want the Message Waiting LED to indicate new messages when the phone receives unsolicited MWI notifications.</p>

NAT Traversal Settings	Description
Enable STUN	Enables or disables STUN (Simple Traversal of UDP through NATs) for account x. The Enable STUN setting allows the phone to identify its publicly addressable information behind a NAT via communicating with a STUN server.
Server address	Enter the STUN server IP address or domain name.
Server port	Enter the STUN server port.
Enable UDP Keep-Alive	Enables or disables UDP keep-alives. Keep-alive packets are used to maintain connections established through NAT.
Keep-alive interval (secs)	Enter the interval (in seconds) for sending UDP keep-alives.

Music on Hold Settings	Description
Enable Local MoH	Enables or disables a hold-reminder tone that the user hears when a far-end caller puts the call on hold.

Network Conference Settings	Description
Enable Network Conference	Enables or disables network conferencing for account x.
Conference URI	Enter the URI for the network bridge for conference handling on account x.

Session Timer Settings	Description
Enable Session Timer	Enables or disables the SIP session timer. The session timer allows a periodic refreshing of a SIP session using the RE-INVITE message.
Minimum value (secs)	Sets the session timer minimum value (in seconds) for account x.
Maximum value (secs)	Sets the session timer maximum value (in seconds) for account x.

Call Settings

Each account (1 to 6) has its own call settings page. Click on the account to open it.

General Call Settings	Description
Anonymous Call Reject	Enables or disables rejecting calls indicated as "Anonymous."
Enable Anonymous Call	Enables or disables outgoing anonymous calls. When enabled, the caller name and number are indicated as "Anonymous."

Do not Disturb Setting	Description
Enable DND	Turns Do Not Disturb on or off.

Call Forward Settings	Description
Enable Call Forward Always	Enables or disables call forwarding for all calls on that line. Select to enable.
Target Number	Enter a number to which all calls will be forwarded.
Enable Call Forward Busy	Enables or disables forwarding incoming calls to the target number if <ul style="list-style-type: none"> the number of active calls has reached the maximum number of calls configured for account x Call Waiting Off is selected.
Target Number	Enter a number to which calls will be forwarded when Call Forward Busy is enabled.
Enable Call Forward No Answer	Enables or disables call forwarding for unanswered calls on that line.
Target Number	Enter a number to which unanswered calls will be forwarded.
Delay	Select the number of rings before unanswered calls are forwarded.

User Preferences Settings

On this page you can select the language that appears on the WUI.

Handset Settings

On these pages you configure account assignments and names for the handsets registered at the base station.

- **Account assignment.**
 - The Account Assignments table lists the maximum of six handsets, even if there are fewer handsets registered. The registration status of currently registered handsets does not affect what is listed on this table.

- The table always displays the maximum six accounts, even if there are fewer SIP accounts enabled.
- If you have not entered any unique handset names yet, then the default name of "HANDSET" appears.
- On the Account Assignments table, you can select which accounts will be available for both incoming and outgoing calls on each handset.
- The handset will first attempt to use the account you select under Default when going off-hook.
- o **Handset Name.**
 - On the Handset Name page, you can enter a name for each Handset. The Handset Name will be used throughout the WebUI and will appear on the handset Idle screen.
 - The Handset Name is limited to a maximum of 11 characters.
 - The default name is "HANDSET". Blank name fields are not allowed. If you click **Save** when any fields are empty, an error message appears.

Network Settings

Basic Network Settings

Basic Network Settings	Description
DHCP	DHCP is selected (enabled) by default, which means the phone will get its IP address, Subnet Mask, Gateway, and DNS Server(s) from the network. When DHCP is disabled, you must enter a static IP address for the phone, as well as addresses for the Subnet Mask, Gateway, and DNS Server(s).
Static IP	When Static IP is selected, you must enter a static IP address for the phone, as well as addresses for the Subnet Mask, Gateway, and DNS Server(s).
IP Address	If DHCP is disabled, enter a static IP address for the phone.
Subnet Mask	Enter the subnet mask.
Gateway	Enter the address of the default gateway (in this case, your router).
Primary DNS	If DHCP is disabled, enter addresses for the primary and secondary DNS servers.
Secondary DNS	

Advanced Network Settings

VLAN Settings	Description
Enable LAN Port VLAN	Enable if the phone is part of a VLAN on your network. Select to enable.
VID	Enter the VLAN ID (vlan 5, for example).
Priority	Select the VLAN priority that matches the Quality of Service (QOS) settings that you have set for that VLAN ID. Outbound SIP packets will be marked and sent according to their priority. 7 is the highest priority.

LLPD-MED Settings	Description
Enable LLDP-MED	Enables or disables Link Layer Discovery Protocol for Media Endpoint Devices (LLDP-MED). LLDP-MED is a standards-based discovery protocol supported on some network switches. It is required for auto-configuration with VLAN settings.
Packet Interval (secs)	Sets the LLDP-MED packet interval (in seconds).

802.1x Settings	Description
Enable 802.1x	Enables or disables the 802.1x authentication protocol. This protocol allows the phone to attach itself to network equipment that requires device authentication via 802.1x.
Identity	Enter the 802.1x EAPOL identity.
MD5 Password	Enter the 802.1x EAPOL MD5 password.

Contacts

Base directory settings

This is the "local" directory on the base station, as opposed to external, server-based directories like LDAP. On the **Base Directory** page, you can manage directory entries that will be available on all handsets registered at the base station. You can sort, edit, delete, and add contact information for up to 200 entries. In order to back up your contacts or import another local directory file, the page also enables you to export and import the base directory.

- Adding, editing, and deleting entries and page navigation: See "Contacts" on page 60.
- For general information on the available directories, see "Directories" on page 40.

Base Directory Settings	Description	Range	Default
First Name	Enter the appropriate names in these fields. The maximum length of the first name and last name fields is 15 characters.	N/A	Blank
Last Name			
Ringer Tone	Sets a unique ringer tone for calls from this directory entry.	Auto, Tone 1–10	Tone 1
Account	Sets the account used when you dial this directory entry.	Default Account, Account 1–6	Default Account
Work Number	Enter the appropriate numbers in these fields.	N/A	Blank
Mobile Number			
Other Number			

Blacklist (deny list) settings

Blacklist Settings	Description	Range	Default
First Name	Enter the appropriate names in these fields. The maximum length of the first name and last name fields is 15 characters.	N/A	Blank
Last Name			
Account	Sets the account used when you dial this directory entry.	Default Account, Account 1–6	Default Account
Work Number	Enter the appropriate numbers in these fields.	N/A	Blank
Mobile Number			
Other Number			

LDAP settings

LDAP Settings	Description
Enable LDAP	When enabled, LDAP is available in the handsets' directory menu
Directory Name	LDAP directory name
Server Address	IP address of the LDAP server
Port	Server port for LDAP
Version	Select the LDAP protocol version supported on the phone. Ensure the protocol value matches the version assigned on the LDAP server.
Authentication Scheme	Select the LDAP server authentication scheme.
Authentication Name	Enter the user name or authentication name for LDAP server access.
Authentication Password	Enter the authentication password for LDAP server access.

Base	Enter the LDAP search base. This sets where the search begins in the directory tree structure. Enter one or more attribute definitions, separated by commas (no spaces). Your directory may include attributes like "cn" (common name) or "ou" (organizational unit) or "dc" (domain component). Example: ou=accounting,dc=snom,dc=com
Maximum Number of Entries	Sets the maximum number of entries returned for an LDAP search. Limiting the number of hits can conserve network bandwidth.
Maximum Search Delay	Enter the delay (in seconds) before the phone starts returning search results.
First Name Filter	Enter the first name attributes for LDAP searching. The format of the search filter is compliant to the standard string representations of LDAP search filters (RFC 2254).
Last Name Filter	Enter the last name attributes for LDAP searching. The format of the search filter is compliant to the standard string representations of LDAP search filters (RFC 2254).
Phone Number Filter	Enter the number attributes for LDAP searching. The format of the search filter is compliant to the standard string representations of LDAP search filters (RFC 2254).
First Name Attribute	Sets the attribute for first name. What you enter here should match the first name attribute for entries on the LDAP server (gn for givenName, for example). This helps ensure that the phone displays LDAP entries in the same format as the Local Directory.
Last Name Attribute	Sets the attribute for last name. What you enter here should match the last name attribute for entries on the LDAP server (sn for surname, for example). This helps ensure that the phone displays LDAP entries in the same format as the Local Directory.
Work Phone Number Attribute	Sets the attribute for the work number. What you enter here should match the work number attribute for entries on the LDAP server (telephoneNumber, for example). This helps ensure that the phone displays LDAP entries in the same format as the Local Directory.
Mobile Phone Number Attribute	Sets the attribute for the mobile number. What you enter here should match the mobile number attribute for entries on the LDAP server (mobile, for example). This helps ensure that the phone displays LDAP entries in the same format as the Local Directory.
Other phone number attribute	Sets the attribute for the other number. What you enter here should match the other number attribute for entries on the LDAP server (otherPhone, for example). This helps ensure that the phone displays LDAP entries in the same format as the Local Directory.
Lookup for Incoming Calls	Enables or disables LDAP incoming call lookup. If enabled, the phone searches the LDAP directory for the incoming call number. If the number is found, the phone uses the LDAP entry for CID info.
Lookup in Dialing Mode	Enables or disables LDAP outgoing call lookup. If enabled, numbers entered in pre-dial or live dial are matched against LDAP entries. If a match is found, the LDAP entry is displayed for dialing.

Servicing pages

Reboot

Click the **Reboot** button to reboot the phone and apply updated settings requiring reboot.

Time and Date

Time and Date Format Settings	Description
Date Format	Select a format from the drop-down menu. Available formats are day/month/year (DD/MM/YY), month/day/year (MM/DD/YR), year/month/day (YR/MM/DD).
Time Format	Select 24-hour or 12-hour format from the drop-down menu.

Network Time Settings	Description
Enable Network Time	Enables or disables getting time and date information for your phone from the Internet.
NTP Server	If Enable Network Time is selected, enter the URL of your preferred time server.
Use DHCP (Option 42)	If Enable Network Time is selected, select to use DHCP to locate the time server. Option 42 specifies the NTP server available to the phone. When enabled, the phone obtains the time in the following priority: <ol style="list-style-type: none"> 1. Option 42 2. NTP Server 3. Manual time
<p>If Enable Network Time is disabled or if the time server is not available, use Manual Time Settings to set the current time. After entering the date and time, click on the Apply Now button to start the phone using the manual settings.</p>	

Time Zone and Daylight Saving Settings	Description
Time Zone	Select your time zone from the list.
Automatically adjust clock for Daylight Saving	Select to adjust the clock for daylight saving time according to the NTP server and time zone setting. To disable daylight saving time adjustment, disable both this setting and User-defined DST .
User-defined DST	Select to set your own start and end dates and offset for daylight saving time. To disable daylight saving adjustment, disable both this setting and Automatically adjust clock for Daylight Saving .
DST Start: Month DST Start: Week DST Start: Day DST Start: Hour	If User-defined DST is enabled, set the start date and time for daylight saving: Month, week, day, and hour.
DST End: Month DST End: Week DST End: Day DST End: Hour	If User-defined DST is enabled, set the end date and time for daylight saving: Month, week, day, and hour.
Daylight Saving Offset	If User-defined DST is enabled, this specifies the daylight saving adjustment (in minutes) to be applied when the current time is between Daylight Saving Start and Daylight Saving End .
Use DHCP (Option 2/100/101)	If Enable Network Time is selected, select to use DHCP to determine the time zone offset. Options 2, 100 and 101 determine time zone information.

Manual Time Settings	Description
<p>If Enable Network Time is disabled or if the time server is not available, use Manual Time Settings to set the current time. After entering the date and time, click on the Apply Now button to start the phone using the manual settings.</p>	
Date	Select the current year, month, and day. Click the Date field and select the date from the calendar that appears.
Time	Sets the current hour, minute, and second. Click the Time field, and enter the current time. You can also refresh the page to update the manual time settings.

Firmware Upgrade

Use one of the following methods to update the firmware:

- **Auto Upgrade.** Retrieving a firmware update file from a remote host computer and accessed via a URL. This central location may be arranged by you, an authorized dealer, or your SIP service provider. Enter the URL under Firmware Server Settings. Click **Update Base Firmware Now** and **Update Handset Firmware Now** to update immediately.
- **Manual Upgrade.** Using a file located on your computer or local network. No connection to the Internet is required. Consult your dealer for access to firmware update files. Click Manual Upgrade to view the page where you can manually upgrade the phone firmware.

Firmware Server Settings	Description
Base Firmware URL	The URL where the phone base station firmware update file resides. This should be a full path, including the filename of the firmware file.
Handset Firmware URL	The URL where the handset firmware update file resides. This should be a full path, including the filename of the firmware file.
Server authentication name	Authentication username for the firmware server.
Server authentication password	Authentication password for the firmware server.

Provisioning settings

Provisioning Server Settings	Description
Server URL	URL of the provisioning file(s). The format of the URL must be RFC 1738 compliant, as follows: " <code><schema>://<user>:<password>@<host>:<port>/<url-path></code> " " <code><user>:<password>@</code> " may be empty. " <code><port></code> " can be omitted if you do not need to specify the port number.
Server authentication name	User name for access to the provisioning server
Server authentication password	Password for access to the provisioning server

Plug-and-Play Settings	Description
Enable PnP Subscribe	Select to enable the phone to search for the provisioning URL via a SUBSCRIBE message to a multicast address (224.0.1.75). The phone expects the server to reply with a NOTIFY that includes the provisioning URL. The process times out after five attempts.

DHCP Settings	Description
Use DHCP Options	Enables the phone to use DHCP options to locate and retrieve the configuration file. When selected, the phone automatically attempts to get a provisioning server address, and then the configuration file. If DHCP options do not locate a configuration file, then the server provisioning string is checked. Note: Ensure that DHCP is also enabled on the "Basic Network Settings" page.
DHCP Option Priority 1	If DHCP is enabled, sets the DHCP Option priority. Select the highest priority option.
DHCP Option Priority 2	If DHCP is enabled, sets the DHCP Option priority. Select the second highest priority option.
DHCP Option Priority 3	If DHCP is enabled, sets the DHCP Option priority. Select the third highest priority option.
Vendor Class ID (DHCP 60)	DHCP Option 60 is available to send vendor-specific information to the DHCP Server.
User Class Info (DHCP 77)	DHCP Option 77 is available to send vendor-specific information to the DHCP Server.

Resynchronization Settings	Description
Mode	Sets which files for which the phone checks. It can check for configuration files, firmware update files (from the URL entered on the Firmware Server Settings page), or both. Note: When checking for both configuration and firmware files, the firmware URL can be within the config file. This firmware URL takes precedence over the URL on the Firmware Server Settings page. It will also update the URL on the Firmware Server Settings page. This allows you to change the firmware URL automatically.
Bootup Check	Sets the phone to check the provisioning URL for new configuration and/or firmware files upon bootup. The update is applied as part of the reboot process.
Schedule Check: Disable	When selected, disables regularly scheduled file checking.
Schedule Check: Interval	Sets an interval for checking for updates. After selecting Interval, enter the interval in minutes between update checks.
Schedule Check: Days of the Week	Select to enable weekly checking for updates on one or more days. After selecting Days of the Week, select the day(s) on which the phone checks for updates.
Start Hour	Select the hour of the day on which the phone checks for updates.
End Hour	Select the hour of the day on which the phone stops checking for updates.
Use encryption	Enables an AES-encrypted configuration file to be decrypted before being applied to the phone. Select if the configuration file has been secured using AES encryption.
Passphrase	If the configuration file has been secured using AES encryption, enter the 16-bit key.

Security Settings

On the **Security** page you can change the admin and user passwords and enter web server settings and trusted IPs.

Web Server Settings	Description
HTTP Server port	Port used by the HTTP server. The default is 80.
Enable Secure Browsing	When enabled, the HTTPS protocol is used, and you must select the HTTPS server port in the next step.
HTTPS Server port	Port used by the HTTPS server. The default is 443.
Note: Changing the web server settings will reboot the base station.	

Certificates

- **Device Certificate.** You can upload an optional web server certificate to the base station to establish a secure connection between phone and server. If a certificate is not available, the base station's self-signed certificate will be used during the connection transaction.
- **Trusted Certificates.**

System Logs

- On the **Syslog Settings** page, you can enter settings related to system logging activities. It supports the following logging modes:
 - Syslog server
 - Volatile file

Settings	Description
Enable Syslog	Enable log output to syslog server.
Server address	Syslog server IP address.
Server port	Syslog server port.
Log Level	Sets the log level. The higher the level, the larger the debug output. 5—ALL 4—DEBUG 3—INFO 2—WARNING 1—ERROR 0—CRITICAL

The logging levels are:

CRITICAL: Operating conditions to be reported or corrected immediately (for example, an internal component failure or file system error).

ERROR: Non-urgent failures - unexpected conditions that won't cause the device to malfunction.

WARNING: An indication that an error or critical condition can occur if action is not taken.

INFO: Normal operational messages.

DEBUG: Developer messages for troubleshooting/debugging purposes.

- Under **Network Trace**, you can capture network traffic related to the phone's activity and save the capture as a .pcap file. The file can be used for diagnostic and troubleshooting purposes.

Performing a network trace:

1. Start a network trace by clicking **Start**. The button changes to **Stop**.
2. Stop the network trace by clicking **Stop**.
3. Save the trace by clicking **Save to file**. Your browser should prompt you to save the **capture.pcap** file.

- Under **Download Log**, you can save the system log to a file.

1. Click **Save Log to file**.
2. After your browser prompts you to save the **system.log** file, save the file in the desired location.