



Cisco UCS C240 M5 Rack Server (Small Form Factor Disk Drive Model)

CONTENTS

OVERVIEW	5
DETAILED VIEWS	6
Chassis Front View	6
Chassis Rear View	8
BASE SERVER STANDARD CAPABILITIES and FEATURES	10
CONFIGURING the SERVER	14
STEP 1 VERIFY SERVER SKU	15
STEP 2 SELECT RISER CARDS (OPTIONAL)	16
STEP 3 SELECT CPU(s)	17
STEP 4 SELECT MEMORY	20
STEP 5 SELECT RAID CONTROLLERS	23
RAID Controller Options (internal HDD/SSD support)	23
Embedded Software RAID	23
Cisco 12G SAS RAID Controller	23
Cisco 12G SAS HBA (internal HDD/SSD/JBOD support)	23
RAID Volumes and Groups	23
STEP 6 SELECT DRIVES	28
STEP 7 SELECT PCIe OPTION CARD(s)	31
STEP 8 ORDER GPU CARDS (OPTIONAL)	34
STEP 9 ORDER POWER SUPPLY	36
STEP 10 SELECT INPUT POWER CORD(s)	37
STEP 11 ORDER TOOL-LESS RAIL KIT AND OPTIONAL REVERSIBLE CABLE MANAGEMENT ARM	41
STEP 12 SELECT MANAGEMENT CONFIGURATION (OPTIONAL)	42
STEP 13 SELECT SERVER BOOT MODE (OPTIONAL)	43
STEP 14 SELECT LOCKING SECURITY BEZEL (OPTIONAL)	44
STEP 15 ORDER SECURITY DEVICES (OPTIONAL)	45
STEP 16 ORDER OPTICAL DRIVE (OPTIONAL)	46
STEP 17 ORDER CISCO SD CARD MODULE (OPTIONAL)	47
STEP 18 ORDER M.2 SATA SSD (OPTIONAL)	48
STEP 19 ORDER INTERNAL MICRO-SD CARD MODULE (OPTIONAL)	49
STEP 20 ORDER OPTIONAL USB 3.0 DRIVE	50
STEP 21 SELECT OPERATING SYSTEM AND VALUE-ADDED SOFTWARE	51
STEP 22 SELECT OPERATING SYSTEM MEDIA KIT	57
STEP 23 SELECT SERVICE and SUPPORT LEVEL	58
OPTIONAL STEP - ORDER RACK(s)	64
OPTIONAL STEP - ORDER PDU	66
SUPPLEMENTAL MATERIAL	67
CHASSIS	67
BLOCK DIAGRAM	70
RAID Option ROM (OPROM) Settings	71
Riser Card Configuration and Options	72
Serial Port Details	78
Upgrade and Servicing-Related Parts	79
RACKS	81
PDUs	82
KVM CABLE	83
TECHNICAL SPECIFICATIONS	84
Dimensions and Weight	84

Power Specifications	85
Environmental Specifications	88
Compliance Requirements	90

CONTENTS

OVERVIEW

UCS C240 M5 SFF server extends the capabilities of Cisco's Unified Computing System portfolio in a 2U form factor with the addition of the Intel® Xeon® Processor Scalable Family, 24 DIMM slots for 2666 MHz DDR4 DIMMs and capacity points up to 128GB, up to 6 PCI Express (PCIe) 3.0 slots, and up to 26 internal SFF drives. The C240 M5 SFF server also includes one dedicated internal slot for a 12G SAS storage controller card.

The C240 M5 server includes a dedicated internal modular LAN on motherboard (mLOM) slot for installation of a Cisco Virtual Interface Card (VIC) or third-party network interface card (NIC), without consuming a PCI slot, in addition to 2 x 10Gbase-T Intel x550 embedded (on the motherboard) LOM ports.

The Cisco UCS C240 M5 server can be used standalone, or as part of the Cisco Unified Computing System, which unifies computing, networking, management, virtualization, and storage access into a single integrated architecture enabling end-to-end server visibility, management, and control in both bare metal and virtualized environments.

Figure 1 Cisco UCS C240 M5 SFF Rack Server (26-drive version)

Front View



Rear View



DETAILED VIEWS

Chassis Front View

Figure 2 shows the 26-drive Cisco UCS C240 M5 SFF Rack Server.

Figure 2 Chassis Front View (26-drive version)

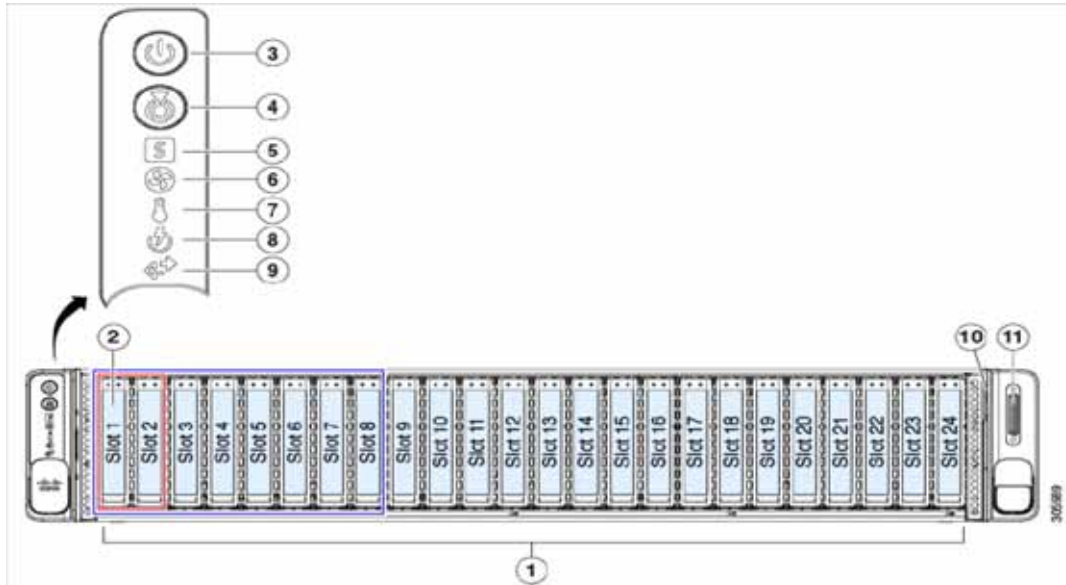

1	Drive bays 1-24 support 2.5-inch SAS/SATA hard disk drives (HDDs) and solid state drives (SSDs).	7	Temperature status LED
2	2.5-inch NVMe PCIe SSD support: <ul style="list-style-type: none"> ■ Server PID UCSC-C240-M5SX: Drive bays 1-2 support 2.5-inch NVMe PCIe SSDs. All drive bays support SAS/SATA drives ■ Server PID UCSC-C240-M5SN¹: Drive bays 1-8 support 2.5-inch NVMe PCIe SSDs. The remainder of the drive bays (9-24) support SAS/SATA drives. 	8	Power supply status LED
3	Power button/LED	9	Network link activity LED
4	Unit Identification button/LED	10	Pull-out asset tag
5	System status LED	11	KVM connector (used with KVM cable that provides two USB 2.0, one VGA, and one serial connector)
6	Fan status LED		

Notes:

1. Available at the end of CY 2017.

Figure 3 shows the 10-drive Cisco UCS C240 M5 SFF Rack Server.

Figure 3 Chassis Front View (10-drive version)

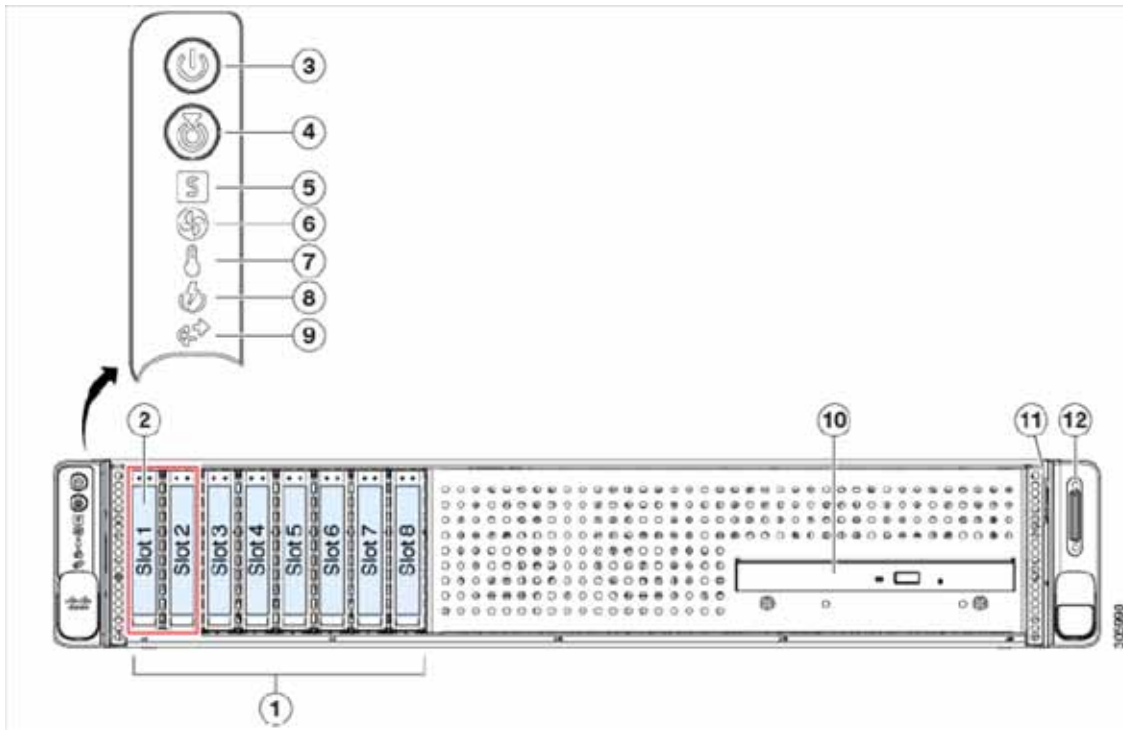

1	Drive bays 1-8 support 2.5-inch SAS/SATA hard disk drives (HDDs) and solid state drives (SSDs).	7	Temperature status LED
2	Drive bays 1 and 2 support 2.5-inch NVMe PCIe SSDs.	8	Power supply status LED
3	Power button/LED	9	Network link activity LED
4	Unit Identification button/LED	10	Optional media drive (DVD)
5	System status LED	11	Pull-out asset tag
6	Fan status LED	12	KVM connector (used with KVM cable that provides two USB 2.0, one VGA, and one serial connector)

Chassis Rear View

Figure 4 shows the external features of the rear panel (identical for all server versions).

Figure 4 Chassis Rear View

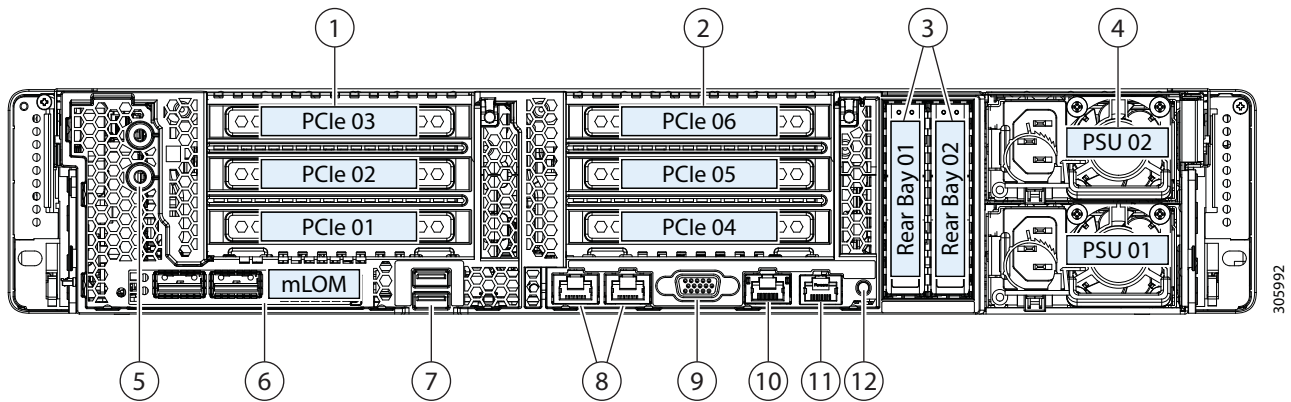

1	<p>PCIe riser 1 (slots 1, 2, 3)</p> <p>Two options:</p> <ul style="list-style-type: none"> ■ Riser 1 option <ul style="list-style-type: none"> • slot 1 (x8, CPU1 controlled) • slot 2 (x16, CPU1 controlled) • slot 3 (x8, CPU2 controlled) ■ Riser 1B option <ul style="list-style-type: none"> • slot 1 (x8, CPU1 controlled) • slot 2 (x8, CPU1 controlled) • slot 3 (x8, CPU1 controlled) <p>See Riser Card Configuration and Options, page 72 for details.</p>	7	USB 3.0 ports (two)
2	<p>PCIe riser 2 (slots 4, 5, 6)</p> <p>Four options:</p> <ul style="list-style-type: none"> ■ Riser 2A option <ul style="list-style-type: none"> • slot 4 (x16, CPU2 controlled) • slot 5 (x16, CPU2 controlled) • slot 6 (x8, CPU2 controlled) 	8	<p>Dual 10-Gb Ethernet ports (LAN1, LAN2)</p> <p>LAN1 is left connector, LAN2 is right connector</p>

<p>2 (cont.)</p>	<ul style="list-style-type: none"> ■ Riser 2B option <ul style="list-style-type: none"> • slot 4 (x8, CPU2 controlled) • slot 5 (x16, CPU2 controlled) • slot 6 (x8, CPU2 controlled) • One x8 NVMe connector (for two rear NVMe drives) from slot 4 ■ Riser 2C option <ul style="list-style-type: none"> • slot 4 (x8, CPU2 controlled) • slot 5 (x8, CPU2 controlled) • slot 6 (x8, CPU2 controlled) • Two x8 NVMe connectors (for two front NVMe and two rear NVMe drives) from slots 4 and 5 ■ Riser 2D option (always ships with UCSC- C240-M5SN) <ul style="list-style-type: none"> • slot 4 (x16, CPU2 controlled) • slot 5 (x8, CPU2 controlled) • slot 6 (x8, CPU2 controlled) • One NVMe connector (for two rear drives) from slot 6 <p>See Riser Card Configuration and Options, page 72 for details.</p>		
<p>3</p>	<p>Rear 2.5-inch drive bays:</p> <ul style="list-style-type: none"> ■ Server PID UCSC-C240-M5SN supports up to two NVMe PCIe SSDs (only), controlled by Riser 2. ■ All other C240 M5 PIDs support up to two rear drives: <ul style="list-style-type: none"> • When using a hardware RAID controller card in the server, SAS/SATA HDDs or SSDs are supported in the rear bays. Alternatively, NVMe drives are also supported in the rear bays, controlled by Riser 2. 	<p>9</p>	<p>VGA video port (DB-15 connector)</p>
<p>4</p>	<p>Power supplies (two, redundant as 1+1)</p>	<p>10</p>	<p>1-Gb Ethernet dedicated management port</p>
<p>5</p>	<p>Screw holes for dual-hole grounding lug</p>	<p>11</p>	<p>Serial port (RJ-45 connector)</p>
<p>6</p>	<p>Modular LAN-on-motherboard (mLOM) card slot (x16)</p>	<p>12</p>	<p>Rear Unit Identification button/LED</p>

BASE SERVER STANDARD CAPABILITIES and FEATURES

Table 1 lists the capabilities and features of the base server. Details about how to configure the server for a particular feature or capability (for example, number of processors, disk drives, or amount of memory) are provided in *CONFIGURING the SERVER, page 14*.

Table 1 Capabilities and Features

Capability/Feature	Description
Chassis	Two rack unit (2RU) chassis
CPU	One or two Intel® Xeon® processor scalable family CPUs
Chipset	Intel® C620 series chipset
Memory	24 slots for registered ECC DIMMs (RDIMMs), load-reduced DIMMs (LRDIMMs), or through silicon via (TSV) DIMMs
Multi-bit Error Protection	This server supports multi-bit error protection.
Video	The Cisco Integrated Management Controller (CIMC) provides video using the ASPEED Pilot 4 video/graphics controller: <ul style="list-style-type: none"> ■ Integrated 2D graphics core with hardware acceleration ■ DDR2/3 memory interface supports up to 16 MB directly accessible from host and entire DDR memory indirectly accessible from host processor. ■ Supports all display resolutions up to 1920 x 1200 x 32bpp resolution at 60Hz ■ High speed Integrated 24-bit RAMDAC ■ Single lane PCI-Express Gen2 host interface ■ eSPI processor to BMC support
SATA Interposer Board	An optional SATA interposer board supports up to eight front facing SATA-only drives.
Power subsystem	Up to two of the following hot-swappable power supplies: <ul style="list-style-type: none"> ■ 1050 W (AC) ■ 1050 W (DC) ■ 1600 W (AC)
WoL	One power supply is mandatory; one more can be added for 1 + 1 redundancy.
Front Panel	The Intel x550 10Gbase-T Ethernet LAN ports support the wake-on-LAN (WoL) standard.
ACPI	A front panel controller provides status indications and control buttons.
Fans	This server supports the advanced configuration and power interface (ACPI) 4.0 standard. <ul style="list-style-type: none"> ■ Six hot-swappable fans for front-to-rear cooling

Capability/Feature	Description
Infiniband Expansion slots	<p>The InfiniBand architecture is supported by the PCIe slots. Up to six PCIe slots (on two riser cards)</p> <ul style="list-style-type: none"> ■ Riser 1 (PCIe slots 1, 2, and 3), controlled by CPU 1 and CPU 2 <ul style="list-style-type: none"> • Option 1A: three slots available. <ul style="list-style-type: none"> Slot 1 = full height, 3/4 length, x8, 230 pins, CPU1, NCSI support. Slot 2 = full height, full length, x16, 230 pins, CPU1, NCSI and GPU support. Slot 3 = full height, half length, x8, 164 pins, CPU2. • Option 1B: three slots available. <ul style="list-style-type: none"> Slot 1 = full height, 3/4 length, x8, 230 pins, CPU1, NCSI support. Slot 2 = full height, full length, x8, 230 pins, CPU1, NCSI support. Slot 3 = full height, full length, x8, 164 pins, CPU1. ■ Riser 2 (PCIe slots 4, 5, and 6), all controlled by CPU 2. Three slots available. <ul style="list-style-type: none"> • Option 2A: three slots available <ul style="list-style-type: none"> Slot 4 = full height, 3/4 length, x16, 230 pins, NCSI support. Slot 5 = full height, full length, x16, 230 pins, NCSI and GPU support. Slot 6 = full height, full length, x8, 164 pins. • Option 2B: three slots available <ul style="list-style-type: none"> Slot 4 = full height, 3/4 length, x8, 230 pins, NCSI support. Slot 5 = full height, full length, x16, 230 pins, NCSI and GPU support. Slot 6 = full height, full length, x8, 164 pins. One connector for two rear SFF NVMe drives (from slot 4) • Option 2C: three slots available <ul style="list-style-type: none"> Slot 4 = full height, 3/4 length, x8, 230 pins, NCSI support. Slot 5 = full height, full length, x8, 230 pins, NCSI and GPU support. Slot 6 = full height, full length, x8, 164 pins. One connector for two rear 2.5 inch NVMe drives (from slot 4) and one connector for two front 2.5 inch NVMe drives (from slot 5) • Option 2D: three slots available (always ships with UCSC-C240-M5SN, not available for other chassis versions) <ul style="list-style-type: none"> Slot 4 = full height, 3/4 length, x16, 164 pins, NCSI support. Also supports PCIe switch card for supporting 8 front 2.5 NVMe drives Slot 5 = full height, full length, x8, 230 pins, NCSI support. Slot 6 = full height, full length, x8, 164 pins. One connector for two rear 2.5 inch NVMe drives (from slot 6) ■ Dedicated RAID controller slot (see Figure 6 on page 67) <ul style="list-style-type: none"> • An internal slot is reserved for the Cisco 12G SAS RAID controller or the Cisco 12G SAS HBA. <p>For more details on riser 1 and riser 2 see Riser Card Configuration and Options, page 72.</p>

Capability/ Feature	Description
Internal storage devices	<ul style="list-style-type: none"> ■ UCSC-C240-M5SX: <ul style="list-style-type: none"> • 24 SFF front-facing SAS/SATA hard drives (HDDs) or SAS/SATA solid state drives (SSDs). • Optionally, up to two front-facing SFF NVMe PCIe SSDs (replacing SAS/SATA drives). These drives must be placed in front drive bays 1 and 2 only and are controlled from Riser 2 option C. • Optionally, up to two SFF, rear-facing SAS/SATA HDDs/SSDs or up to two rear-facing SFF NVMe PCIe SSDs. Rear facing SFF NVMe drives are connected from Riser 2, Option B or C. ■ UCSC-C240-M5SN¹: <ul style="list-style-type: none"> • Up to eight front-facing SFF NVMe PCIe SSDs only (replacing SAS/SATA drives). These drives must be placed in front drive bays 1 through 8 only and are connected from Riser 2 slot 4 (from a PCIe switch). • 16 SFF front-facing SAS/SATA hard drives (HDDs) or SAS/SATA solid state drives (SSDs). Drives occupy slots 9-24. • Optionally, up to two SFF, rear-facing SFF NVMe PCIe SSDs (must be NVMe only).Rear facing NVMe drives are connected from Riser 2. ■ UCSC-C240-M5S: <ul style="list-style-type: none"> • Eight SFF, front-facing SAS/SATA HDDs or SSDs. • Optionally, up to two front-facing NVMe PCIe SSDs (replacing SAS/SATA drives). These drives must be placed in front drive bays 1 and 2 only and are controlled from Riser 2 option C. • Optionally, up to two SFF, rear-facing SAS/SATA HDDs/SSDs or up to two rear-facing SFF NVMe PCIe SSDs. Rear facing SFF NVMe drives are connected from Riser 2, Option B or C. • Optionally, one front-facing DVD drive
Internal storage devices (cont.)	<ul style="list-style-type: none"> ■ One internal USB 3.0 port on the motherboard that you can use with an optional 16 GB USB thumb drive for additional storage. ■ A mini-storage module connector on the motherboard supports either: <ul style="list-style-type: none"> • An SD card module with two SD card slots. Mixing different capacity SD cards is not supported. • An M.2 module with two SATA M.2 SSD slots.Mixing different capacity M.2 modules is not supported.
	<p>NOTE: SD cards and M.2 cannot be mixed. M.2 does not support RAID1 with VMWare. Windows and Linux supported only.</p>

Capability/Feature	Description
I/O Interfaces	<ul style="list-style-type: none"> ■ One slot for a micro-SD card on PCIe Riser 1 (Option 1 and 1B). The micro-SD card serves as a dedicated local resource for utilities such as HUU. Images can be pulled from a file share (NFS/CIFS) and uploaded to the cards for future use. ■ Rear panel <ul style="list-style-type: none"> • One 1-Gbps RJ-45 management port (Marvell 88E6176) • Two 10GBase-T LOM ports (Intel X550 controller embedded on the motherboard) • One RS-232 serial port (RJ45 connector) • One DB15 VGA connector • Two USB 3.0 port connectors • One flexible modular LAN on motherboard (mLOM) slot that can accommodate various interface cards ■ Front panel <ul style="list-style-type: none"> • One KVM console connector (supplies two USB 2.0 connectors, one VGA DB15 video connector, and one serial port (RS232))
Storage controller	<ul style="list-style-type: none"> ■ Embedded RAID (software RAID) <ul style="list-style-type: none"> • Supports up to 8 SATA-only drives • Requires a SATA interposer board ■ Cisco 12G SAS RAID controller card with internal SAS connectivity. <ul style="list-style-type: none"> • Supports up to 26 internal SAS/SATA drives • Plugs into a dedicated RAID controller slot • Supports RAID 0, 1, 5, 6, 10, 50, 60 or JBOD mode ■ Cisco 12G SAS HBA (JBOD/Pass-through Mode) <ul style="list-style-type: none"> • Supports up to 26 SAS/SATA internal drives • Plugs into the dedicated RAID controller slot
Modular LAN on Motherboard (mLOM) slot	<p>The dedicated mLOM slot on the motherboard can flexibly accommodate the following cards:</p> <ul style="list-style-type: none"> ■ Cisco Virtual Interface Cards ■ Quad Port Intel i350 1GbE RJ45 mLOM Network Interface Card (NIC) <hr/> <p> NOTE: The four Intel i350 ports are provided on an optional card that plugs into the mLOM slot, and are separate from the two embedded (on the motherboard) LAN ports</p>
Integrated management processor	<p>Baseboard Management Controller (BMC) running Cisco Integrated Management Controller (CIMC) firmware.</p> <p>Depending on your CIMC settings, the CIMC can be accessed through the 1-GbE dedicated management port, the 1-GbE LOM ports, or a Cisco virtual interface card (VIC).</p>
UCSM	<p>CIMC manages certain components within the server, such as the Cisco 12G SAS HBA. UCS Manager (UCSM) runs in the Fabric Interconnect and automatically discovers and provisions some of the server components.</p>

Notes:

1. Available at the end of CY 2017.

CONFIGURING the SERVER

Follow these steps to configure the Cisco UCS C240 M5 SFF Rack Server:

- *STEP 1 VERIFY SERVER SKU, page 15*
- *STEP 2 SELECT RISER CARDS (OPTIONAL), page 16*
- *STEP 3 SELECT CPU(s), page 17*
- *STEP 4 SELECT MEMORY, page 20*
- *STEP 5 SELECT RAID CONTROLLERS, page 23*
- *STEP 6 SELECT DRIVES, page 28*
- *STEP 7 SELECT PCIe OPTION CARD(s), page 31*
- *STEP 8 ORDER GPU CARDS (OPTIONAL), page 34*
- *STEP 8 ORDER GPU CARDS (OPTIONAL), page 34*
- *STEP 9 ORDER POWER SUPPLY, page 36*
- *STEP 10 SELECT INPUT POWER CORD(s), page 37*
- *STEP 11 ORDER TOOL-LESS RAIL KIT AND OPTIONAL REVERSIBLE CABLE MANAGEMENT ARM, page 41*
- *STEP 12 SELECT MANAGEMENT CONFIGURATION (OPTIONAL), page 42*
- *STEP 13 SELECT SERVER BOOT MODE (OPTIONAL), page 43*
- *STEP 14 SELECT LOCKING SECURITY BEZEL (OPTIONAL), page 44*
- *STEP 15 ORDER SECURITY DEVICES (OPTIONAL), page 45*
- *STEP 16 ORDER OPTICAL DRIVE (OPTIONAL), page 46*
- *STEP 17 ORDER CISCO SD CARD MODULE (OPTIONAL), page 47*
- *STEP 18 ORDER M.2 SATA SSD (OPTIONAL), page 48*
- *STEP 19 ORDER INTERNAL MICRO-SD CARD MODULE (OPTIONAL), page 49*
- *STEP 20 ORDER OPTIONAL USB 3.0 DRIVE, page 50*
- *STEP 21 SELECT OPERATING SYSTEM AND VALUE-ADDED SOFTWARE, page 51*
- *STEP 22 SELECT OPERATING SYSTEM MEDIA KIT, page 57*
- *STEP 23 SELECT SERVICE and SUPPORT LEVEL, page 58*
- *OPTIONAL STEP - ORDER RACK(s), page 64*
- *OPTIONAL STEP - ORDER PDU, page 66*

STEP 1 VERIFY SERVER SKU

Select one server product ID (PID) from [Table 2](#).

Table 2 PID of the C240 M5 SFF Rack Base Server

Product ID (PID)	Description
UCSC-C240-M5SX	UCS C240 M5 24 SFF front drives with option for two SFF rear drives with no CPU, memory, HDD, PCIe cards, or power supply
UCSC-C240-M5S	UCS C240 M5 8 SFF front drives with option for two SFF rear drives with no CPU, memory, HDD, PCIe cards, or power supply
UCSC-C240-M5SN ¹	UCS C240 M5 10 SFF NVMe (8 front, 2 rear) and 16 (front) SATA/SATA drives with no CPU, memory, HDD, PCIe cards, or power supply

Notes:

1. Available at the end of CY 2017.

The Cisco UCS C240 M5 server:

- Includes either a 24- or 8-drive backplane.



NOTE: The C240 M5 SFF server hard drive backplane is not field upgradeable. This means, for example, that you cannot “upgrade” from the 8-drive backplane version to the 24-drive backplane version. Likewise, the backplane is not field “downgradeable.”

- Does not include power supply, CPU, memory, hard disk drives (HDDs), solid-state drives (SSDs), NVMe drives, SD cards, riser 1, riser 2, tool-less rail kit, or PCIe cards.



NOTE: Use the steps on the following pages to configure the server with the components that you want to include.

STEP 2 SELECT RISER CARDS (OPTIONAL)

There are two riser cards per server, riser card 1 and 2. There are two options for riser card 1 (1 and 1B) and four options for riser card 2 (2A, 2B, 2C, and 2D). Riser 2D always ships with UCSC-C240-M5SN and is not supported with any other chassis version. Order one riser card 1 and/or one riser 2 card from [Table 3](#). Riser card 1 is the one on the left when viewed from the back of the server and riser card 2 is on the right.

Table 3 Riser 1 Options

Product ID (PID)	Description
PCIe Riser 1 options	
UCSC-PCI-1-C240M5	Riser 1. Includes 3 PCIe slots (x8, x16, x8). Slots 1 and 2 controlled with CPU1; slot 3 controlled with CPU2.
UCSC-PCI-1B-240M5	Riser 1B. Includes 3 PCIe slots (x8, x8, x8). All slots controlled with CPU1.
PCIe Riser 2 options (all slots controlled with CPU2)	
UCSC-PCI-2A-240M5	Riser 2A. Includes 3 PCIe slots (x16, x16, x8) and supports a GPU.
UCSC-PCI-2B-240M5	Riser 2B. Includes 3 PCIe slots (x8, x16, x8) plus 1 NVMe connector (controls two rear SFF NVMe drives) and supports a GPU.
UCSC-PCI-2C-240M5	Riser 2C. Includes 3 PCIe slots (x8, x8, x8) plus 2 NVMe connectors (one connector for two front SFF NVMe drives and one connector for two rear SFF NVMe drives).



NOTE: If no riser 2 option is selected, a riser blanking panel will be installed. You will not be able to install any PCIe cards without a riser selected. Riser 1 is required.

For additional details, see [Riser Card Configuration and Options, page 72](#).

STEP 3 SELECT CPU(s)

The standard CPU features are:

- Intel® Xeon® processor scalable family
- Intel C620 series chipset
- Cache size of up to 38.5 MB

Select CPUs

The available CPUs are listed in [Table 4](#).

Table 4 Available Intel CPUs

Product ID (PID)	Intel Number ¹	Clock Freq (GHz)	Power (W)	Cache Size (MB)	Cores	UPI ² Links (GT/s)	Highest DDR4 DIMM Clock Support (MHz) ³
Intel® Xeon® Processor Scalable Family CPUs							
UCS-CPU-8180M	8180M	2.5	205	38.50	28	3 × 10.4	2666
UCS-CPU-6142M	6142M	2.6	150	22.00	16	3 × 10.4	2666
UCS-CPU-6134M	6134M	3.2	130	24.75	8	3 × 10.4	2666
UCS-CPU-8176M	8176M	2.1	165	38.50	28	3 × 10.4	2666
UCS-CPU-8170M	8170M	2.1	165	35.75	26	3 × 10.4	2666
UCS-CPU-8160M	8160M	2.1	150	33.00	24	3 × 10.4	2666
UCS-CPU-6140M	6140M	2.3	140	24.75	18	3 × 10.4	2666
UCS-CPU-8180	8180	2.5	205	38.50	28	3 × 10.4	2666
UCS-CPU-8176	8176	2.1	165	38.50	28	3 × 10.4	2666
UCS-CPU-8170	8170	2.1	165	35.75	26	3 × 10.4	2666
UCS-CPU-8168	8168	2.7	205	33.00	24	3 × 10.4	2666
UCS-CPU-8164	8164	2.0	150	35.75	26	3 × 10.4	2666
UCS-CPU-8160	8160	2.1	150	33.00	24	3 × 10.4	2666
UCS-CPU-8158	8158	3.0	150	24.75	12	3 × 10.4	2666
UCS-CPU-8156	8156	3.6	105	16.50	4	3 × 10.4	2666
UCS-CPU-8153	8153	2.0	125	22.00	16	3 × 10.4	2666
UCS-CPU-6154	6154	3.0	200	24.75	18	3 × 10.4	2666
UCS-CPU-6152	6152	2.1	140	30.25	22	3 × 10.4	2666
UCS-CPU-6150	6150	2.7	165	24.75	18	3 × 10.4	2666
UCS-CPU-6148	6148	2.4	150	27.50	20	3 × 10.4	2666
UCS-CPU-6142	6142	2.6	150	22.00	16	3 × 10.4	2666
UCS-CPU-6140	6140	2.3	140	24.75	18	3 × 10.4	2666
UCS-CPU-6138	6138	2.0	125	27.50	20	3 × 10.4	2666
UCS-CPU-6136	6136	3.0	150	24.75	12	3 × 10.4	2666

Table 4 Available Intel CPUs

Product ID (PID)	Intel Number ¹	Clock Freq (GHz)	Power (W)	Cache Size (MB)	Cores	UPI ² Links (GT/s)	Highest DDR4 DIMM Clock Support (MHz) ³
UCS-CPU-6134	6134	3.2	130	24.75	8	3 × 10.4	2666
UCS-CPU-6132	6132	2.6	140	19.25	14	3 × 10.4	2666
UCS-CPU-6130	6130	2.1	125	22.00	16	3 × 10.4	2666
UCS-CPU-6128	6128	3.4	115	19.25	6	3 × 10.4	2666
UCS-CPU-6126	6126	2.6	125	19.25	12	3 × 10.4	2666
UCS-CPU-5122	5122	3.6	105	16.50	4	2 × 10.4	2666
UCS-CPU-5120	5120	2.2	105	19.25	14	2 × 10.4	2400
UCS-CPU-5118	5118	2.3	105	16.5	12	2 × 10.4	2400
UCS-CPU-5115	5115	2.4	85	13.75	10	2 × 10.4	2400
UCS-CPU-4116	4116	2.1	85	16.50	12	2 × 9.6	2400
UCS-CPU-4114	4114	2.2	85	13.75	10	2 × 9.6	2400
UCS-CPU-4112	4112	2.6	85	8.25	4	2 × 9.6	2400
UCS-CPU-4110	4110	2.1	85	11.00	8	2 × 9.6	2400
UCS-CPU-4108	4108	1.8	85	11.00	8	2 × 9.6	2400
UCS-CPU-3106	3106	1.7	85	11.00	8	2 × 9.6	2133
UCS-CPU-3104	3104	1.7	85	8.25	6	2 × 9.6	2133

Notes:

1. Only CPU PIDs ending in "M" support 1.5 TB/socket of memory, per Intel CPU spec. All other CPU PIDs support 768 GB/socket memory.
2. UPI = Ultra Path Interconnect
3. If higher or lower speed DIMMs are selected than what is shown in the table for a given CPU, the DIMMs will be clocked at the lowest common denominator of CPU clock and DIMM clock.

Supported Configurations

(1) 1-CPU configurations:

- Select any one CPU listed in [Table 4 on page 17](#).

(2) 2-CPU Configurations:

- Select two identical CPUs from any one of the rows of [Table 4 on page 17](#).

Caveats

- You can select either one processor or two identical processors.
- The selection of 1 or 2 CPUs depends on the desired server functionality. See the following sections:
 - [STEP 4 SELECT MEMORY, page 20](#) (memory mirroring section)
 - [Table 7 on page 26](#) (RAID support table)
 - [STEP 6 SELECT DRIVES, page 28](#)
 - [STEP 7 SELECT PCIe OPTION CARD\(s\), page 31](#)
 - [ORDER GPU CARDS \(OPTIONAL\), page 34](#)

STEP 4 SELECT MEMORY

The standard memory features are:

- DIMMs
 - Clock speed: 2666 MHz
 - Ranks per DIMM: 1, 2, 4, or 8
 - Operational voltage: 1.2 V
 - Registered ECC DDR4 DIMMs (RDIMMs), load-reduced DIMMs (LRDIMMs), or through silicon via (TSV) DIMMs.
- Memory is organized with six memory channels per CPU, with up to two DIMMs per channel, as shown in [Figure 5](#).

Figure 5 C240 M5 SFF Memory Organization

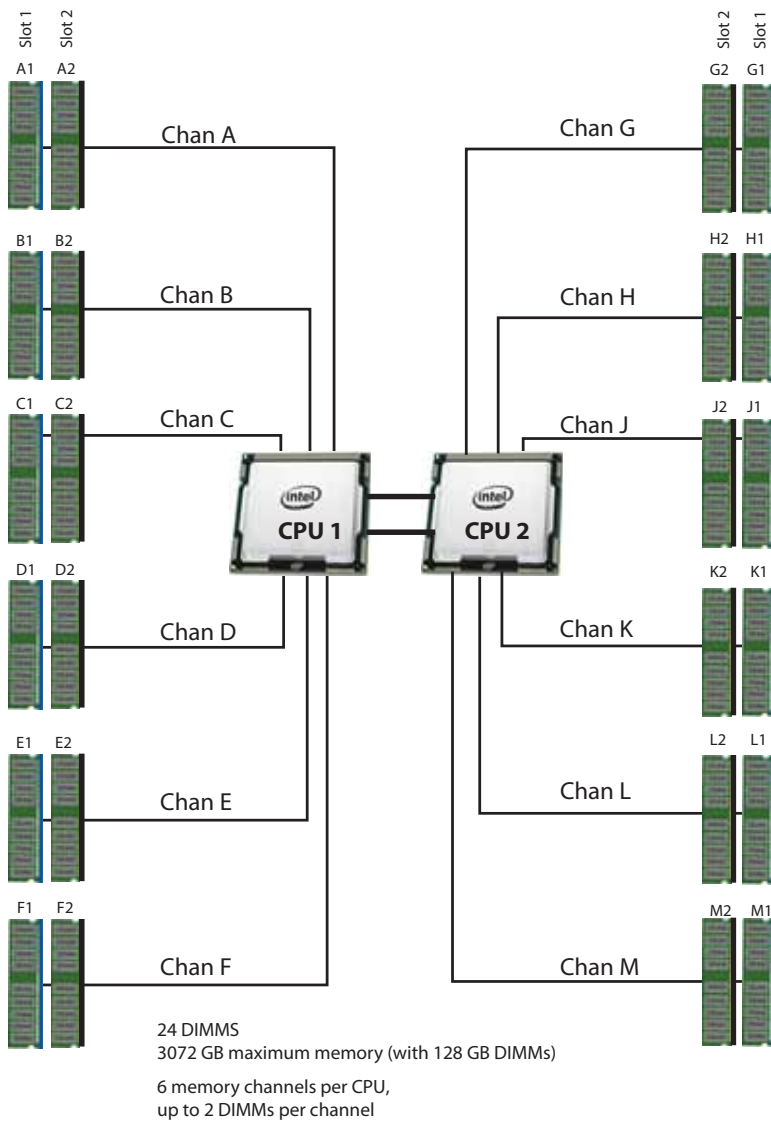

Select DIMMs and Memory Mirroring

Select the memory configuration and whether or not you want the memory mirroring option. The available memory DIMMs and mirroring option are listed in [Table 5](#).



NOTE: When memory mirroring is enabled, the memory subsystem simultaneously writes identical data to two channels. If a memory read from one of the channels returns incorrect data due to an uncorrectable memory error, the system automatically retrieves the data from the other channel. A transient or soft error in one channel does not affect the mirrored data, and operation continues unless there is a simultaneous error in exactly the same location on a DIMM and its mirrored DIMM. Memory mirroring reduces the amount of memory available to the operating system by 50% because only one of the two populated channels provides data.

Table 5 Available DDR4 DIMMs

Product ID (PID)	PID Description	Voltage	Ranks /DIMM
UCS-MR-128G8RS-H	128 GB DDR4-2666-MHz TSV-RDIMM/PC4-21300/8R/x4	1.2 V	8
UCS-MR-X64G4RS-H	64 GB DDR4-2666-MHz TSV-RDIMM/PC4-21300/4R/x4	1.2 V	4
UCS-ML-X64G4RS-H	64 GB DDR4-2666-MHz LRDIMM/PC4-21300/4R/x4	1.2 V	4
UCS-MR-X32G2RS-H	32 GB DDR4-2666-MHz RDIMM/PC4-21300/2R/x4	1.2 V	2
UCS-MR-X16G1RS-H	16 GB DDR4-2666-MHz RDIMM/PC4-21300/1R/x4	1.2 V	1
UCS-MR-X16G2RS-H	16 GB DDR4-2666-MHz RDIMM/PC4-21300/2R/x4	1.2 V	2
UCS-MR-X8G1RS-H	8 GB DDR4-2666-MHz RDIMM/PC4-21300/1R/x4	1.2 V	1
Memory Mirroring Option			
N01-MMIRROR	Memory mirroring option		

Approved Configurations

(1) 1-CPU configuration without memory mirroring:

- Select from 1 to 12 DIMMs.

(2) 1-CPU configuration with memory mirroring:

- Select 4, 6, 8, or 12 identical DIMMs. The DIMMs will be placed by the factory as shown in the following table.

Total Number of DIMMs	CPU 1 DIMM Placement in Channels (for identical ranked DIMMs)
4	(A1, B1); (D1, E1)
6	(A1, B1, C1); (D1, E1, F1)
8	(A1, A2, B1, B2); (D1, D2, E1, E2)
12	(A1, A2, B1, B2, C1, C2); (D1, D2, E1, E2, F1, F2)

- Select the memory mirroring option (N01-MMIRROR) as shown in [Table 5 on page 21](#).

(3) 2-CPU configuration without memory mirroring:

- Select from 1 to 12 DIMMs per CPU.

(4) 2-CPU configuration with memory mirroring:

- Select 8, 12, 16, or 24 identical DIMMs per CPU. The DIMMs will be placed by the factory as shown in the following table.

Number of DIMMs per CPU	CPU 1 DIMM Placement in Channels (for identical ranked DIMMs)	CPU 2 DIMM Placement in Channels (for identical ranked DIMMs)
	CPU 1	CPU 2
8	(A1, B1); (D1, E1)	(G1, H1); (K1, L1)
12	(A1, B1, C1); (D1, E1, F1)	(G1, H1, J1); (K1, L1, M1)
16	(A1, A2, B1, B2); (D1, D2, E1, E2)	(G1, G2, H1, H2); (K1, K2, L1, L2)
24	(A1, A2, B1, B2, C1, C2); (D1, D2, E1, E2, F1, F2)	(G1, G2, H1, H2, J1, J2); (K1, K2, L1, L2, M1, M2)

- Select the memory mirroring option (N01-MMIRROR) as shown in [Table 5 on page 21](#).



NOTE: System performance is optimized when the DIMM type and quantity are equal for both CPUs, and when all channels are filled equally across the CPUs in the server.

STEP 5 SELECT RAID CONTROLLERS

RAID Controller Options (internal HDD/SSD support)

Embedded Software RAID

The default RAID configuration is embedded software RAID, which supports only SATA HDDs and enterprise value SSDs (RAID 0, 1, 10). A maximum of 8 SATA drives are supported with embedded software RAID. Embedded RAID requires a SATA interposer board.



NOTE: Embedded software RAID is limited to Windows and Linux operating systems only. There is no VMWare support for embedded software RAID.

Cisco 12G SAS RAID Controller

You can choose a Cisco 12G SAS RAID controller, which plugs into a dedicated RAID controller card slot. This RAID controller supports RAID 0, 1, 5, 6, 10, 50, 60, and JBOD mode.



NOTE: The number of RAID groups (virtual drives) supported per RAID controller is as follows:

- Embedded RAID = 8
- Cisco 12G SAS RAID controller = 64

Cisco 12G SAS HBA (internal HDD/SSD/JBOD support)

You can choose a SAS HBA for JBOD or Pass-through mode support:

- The Cisco 12G SAS HBA plugs into a dedicated RAID controller slot.

RAID Volumes and Groups

When creating each RAID volume, follow these guidelines:

- Use the same capacity for each drive in each RAID volume
- For embedded software RAID:
 - Use only SATA HDDs
 - Embedded software RAID has two ports and each port can control 4 drives, for 8 drives total.
 - Each set of 4 SATA HDDs for a port must be in separate RAID volumes.
 - You cannot mix drives across ports to create a RAID volume.
- For the Cisco 12G SAS RAID controller upgrade:
 - Use either all SAS HDDs, or all SAS SSDs, or all SATA SSDs in each RAID volume

Select Controller Options

Select as follows:

- For a 26-drive server version, select one of the following:
 - Embedded software RAID (this is the default if no other selection is made), or
 - Cisco 12G SAS RAID controller with 4 GB cache from [Table 6 on page 24](#), or
 - Cisco 12G SAS HBA from [Table 6 on page 24](#), or
- For an 8-drive backplane system, select one of the following:
 - Embedded software RAID (this is the default if no other selection is made), or
 - Cisco 12G SAS RAID controller from [Table 6 on page 24](#), or
 - Cisco 12G SAS HBA (see [Table 6 on page 24](#))



NOTE: The UCSC-C240-M5SN does not support embedded RAID.

For the Cisco 12G SAS RAID controller upgrade, select an appropriate optional RAID configuration listed in [Table 6 on page 24](#)

Table 6 Hardware Controller Options

Product ID (PID)	PID Description
Controllers for Internal Drives	
Note that if the following Cisco 12G SAS RAID controller or Cisco 12G SAS HBA controller is selected, it is factory-installed in the dedicated internal slot.	
UCSC-RAID-M5HD	Cisco 12G SAS RAID Controller with 4 GB FBWC <ul style="list-style-type: none"> ■ Supports up to 26 internal SAS HDDs and SAS/SATA SSDs ■ Supports RAID 0, 1, 5, 6, 10, 50, 60, and JBOD mode ■ (CIMC/UCSM) is supported for configuring and managing local keys. For now, SED drives are managed with local key management only. Third-party key management will be supported (KMIP compliant).
UCSC-RAID-M5	Cisco 12G SAS RAID Controller with 2 GB FBWC <ul style="list-style-type: none"> ■ Supports up to 16 internal SAS HDDs and SAS/SATA SSDs ■ Supports RAID 0, 1, 5, 6, 10, 50, 60, and JBOD mode ■ For all self-encrypting drives (SED), standalone Management (CIMC/UCSM) is supported for configuring and managing local keys. For now, SED drives are managed with local key management only. Third-party key management will be supported (KMIP compliant).

Table 6 Hardware Controller Options (*continued*)

Product ID (PID)	PID Description
UCSC-SAS-M5HD	<p>Cisco 12G SAS HBA for up to 26 drives</p> <ul style="list-style-type: none"> ■ Supports up to 26 internal SAS HDDs and SAS/SATA SSDs ■ Supports JBOD mode only (no RAID functionality. Ideal for SDS (Software Defined Storage) applications. It is also ideal for environments demanding the highest IOPs (for external SSD attach), where a RAID controller can be an I/O bottleneck. ■ No SED drive support.
UCSC-SAS-M5	<p>Cisco 12G SAS HBA for up to 16-drives</p> <ul style="list-style-type: none"> ■ Supports up to 16 internal SAS HDDs and SAS/SATA SSDs ■ Supports JBOD mode only (no RAID functionality. Ideal for SDS (Software Defined Storage) applications. It is also ideal for environments demanding the highest IOPs (for external SSD attach), where a RAID controller can be an I/O bottleneck. ■ No SED drive support.
RAID Configuration Options (not available for Cisco 12G SAS HBA or embedded software RAID)	
R2XX-SRAID0	Enable Single Disk Raid 0 Setting
R2XX-RAID0	Factory preconfigured RAID striping option Enable RAID 0 Setting. Requires a minimum of one hard drive.
R2XX-RAID1	Factory preconfigured RAID mirroring option Enable RAID 1 Setting. Requires exactly two drives with the same size, speed, capacity.
R2XX-RAID5	Factory preconfigured RAID option Enable RAID 5 Setting. Requires a minimum of three drives of the same size, speed, capacity.
R2XX-RAID6	Factory preconfigured RAID option Enable RAID 6 Setting. Requires a minimum of four drives of the same size, speed, capacity.
R2XX-RAID10	Factory preconfigured RAID option Enable RAID 10 Setting. Requires a minimum of four drives of the same size, speed, capacity.



NOTE: Although RAID levels 50 and 60 are not orderable from the factory, they are supported for selected controllers as shown in [Table 6](#)

Approved Configurations

The C240 M5 SFF server can be ordered as a UCSC-C240-M5SX or UCSC-C240-M5SN (26-drive backplane) or a UCSC-C240-M5S (8-drive backplane).

- The embedded software RAID supports up to 8 internal SATA HDDs with RAID 0, 1, 10 support.

- The embedded software RAID does not support rear SAS/SATA drives, front and rear NVMe are supported.
- There is no RAID support for NVMe drives.
- In an embedded RAID configuration, only embedded software RAID (0, 1, 10) is supported, AHCI mode is not supported.
- The Cisco 12G SAS RAID controller upgrade option supports up to 26 internal drives with up to RAID 0, 1, 10, 5, 6, 50, 60, JBOD mode.
- The Cisco 12 Gbps SAS HBA supports up to 26 internal drives with JBOD support.

See [Table 7](#) for a summary of the supported controller configuration options.

Table 7 Supported Controller Configurations

Server Model	# of CPUs	Embedd ed RAID	Cisco 12G SAS RAID Controller or Cisco 12G SAS HBA (<u>only one can be installed at a time</u>)		MAX# Drives Supporte d	RAID Support	Internal Drive Types Allowed
			Cisco 12G SAS RAID Controller	Cisco 12G SAS HBA			
C240 M5 SFF 10 Drives	1	Enabled	Not allowed	Not allowed	8 internal SATA only	0, 1, 10 (SATA only)	SATA HDDs/Enterprise Value SSDs
C240 M5 SFF 10 Drives	1	Not allowed	Installed in a dedicated slot	Installed in a dedicated slot	10 internal	0, 1, 10, 5, 6, 50, 60 JBOD (12G SAS RAID), JBOD (SAS HBA)	SAS HDDs, SAS/SATA SSDs (NVMe requires 2 CPUs)
			Only one of the above can be installed at a time				
C240 M5 SFF 26 Drives	1	Not allowed	Installed in a dedicated slot	Installed in a dedicated slot	26 internal	0, 1, 10, 5, 6, 50, 60 JBOD (12G SAS RAID), JBOD (SAS HBA)	SAS HDDs, SAS/SATA SSDs (NVMe requires 2 CPUs)
			Only one of the above can be installed at a time				
C240 M5 SFF 10 Drives	2	Enabled	Not allowed	Not allowed	8 internal SATA only	0, 1, 10 (SATA only)	SATA HDDs/Enterprise Value SSDs
C240 M5 SFF 10 Drives	2	Not allowed	Installed in a dedicated slot	Installed in a dedicated slot	10 internal	0, 1, 10, 5, 6, 50, 60 JBOD (12G SAS RAID), JBOD (SAS HBA)	SAS HDDs, SAS/SATA SSDs, SFF NVMe
			Only one of the above can be installed at a time				

Table 7 Supported Controller Configurations

Server Model	# of CPUs	Embedded RAID	Cisco 12G SAS RAID Controller or Cisco 12G SAS HBA (<u>only one can be installed at a time</u>)		MAX# Drives Supported	RAID Support	Internal Drive Types Allowed
			Cisco 12G SAS RAID Controller	Cisco 12G SAS HBA			
C240 M5 SFF 26 Drives	2	Not allowed	Installed in a dedicated slot	Installed in a dedicated slot	26 internal	0, 1, 10, 5, 6, 50, 60 JBOD (12G SAS RAID), JBOD (SAS HBA)	SAS HDDs, SAS/SATA SSDs, SFF NVMe
			Only one of the above can be installed at a time				



NOTE: UCS C240 M5 servers with embedded software RAID does not support rear SAS/SATA drives, front and rear SFF NVMe are supported. There is no RAID support for NVMe. In an embedded RAID configuration, only embedded software RAID (0, 1, 10) is supported, AHCI mode is not supported.

STEP 6 SELECT DRIVES

The standard disk drive features are:

- 2.5-inch small form factor
- Hot-pluggable
- Drives come mounted in sleds

Select Front-Facing Drives

The available drives are listed in [Table 8](#).

Table 8 Available Hot-Pluggable Sled-Mounted Front-Loading Drives
(UCSC-C240-M5SX (26-drive system), UCSC-C240-M5S (10-drive system), UCSC-C240-M5N (26-drive system with SFF NVMe-only for rear-facing drives))

Product ID (PID)	PID Description	Drive Type	Capacity
HDDs (15K RPM)			
UCS-HD300G15K12N	300 GB 12G SAS 15K RPM SFF HDD	SAS	300 GB
UCS-HD600G15K12N	600 GB 12G SAS 15K RPM SFF HDD	SAS	600 GB
UCS-HD900G15K12N	900 GB 12G SAS 15K RPM SFF HDD	SAS	900 GB
HDDs (10K RPM)			
UCS-HD300G10K12N	300 GB 12G SAS 10K RPM SFF HDD	SAS	300 GB
UCS-HD600G10K12N	600 GB 12G SAS 10K RPM SFF HDD	SAS	600 GB
UCS-HD12TB10K12N	1.2 TB 12G SAS 10K RPM SFF HDD	SAS	1.2 TB
UCS-HD18TB10K4KN ¹	1.8 TB 12G SAS 10K RPM SFF HDD (4K)	SAS	1.8 TB
HDDs (7.2K RPM)			
UCS-HD1T7K12N	1 TB 12G SAS 7.2K RPM SFF HDD	SAS	1 TB
UCS-HD2T7K12N	2 TB 12G SAS 7.2K RPM SFF HDD	SAS	2 TB
UCS-HD1T7K6GAN	1 TB 6G SATA 7.2K RPM SFF HDD	SAS	1 TB
SAS/SATA SSDs²			
Enterprise Performance SSDs (High endurance, supports up to 10X or 3X DWPD (drive writes per day))³			
UCS-SD400G12TX-EP	400 GB 2.5 inch Enterprise performance 12G SAS SSD (10X DWPD)	SAS	400 GB
UCS-SD800G12TX-EP	800 GB 2.5 inch Enterprise performance 12G SAS SSD (10X DWPD)	SAS	800 GB
UCS-SD16TB12TX-EP	1.6TB 2.5 inch Enterprise performance 12G SAS SSD(10X DWPD)	SAS	1.6 TB
UCS-SD400G123X-EP	400 GB 2.5 inch Enterprise performance 12G SAS SSD(3X DWPD)	SAS	400 GB
UCS-SD800G123X-EP	800 GB 2.5 inch Enterprise performance 12G SAS SSD(3X DWPD)	SAS	800 GB
UCS-SD16T123X-EP	1.6 TB 2.5 inch Enterprise performance 12G SAS SSD(3X DWPD)	SAS	1.6 TB
UCS-SD32T123X-EP	3.2 TB 2.5 inch Enterprise performance 12G SAS SSD(3X DWPD)	SAS	3.2 TB
Enterprise Value SSDs (Low endurance, supports up to 1X DWPD (drive writes per day))⁴			
UCS-SD120GM1X-EV	120 GB 2.5 inch Enterprise Value 6G SATA SSD (Micron 5100 ECO)	SATA	120 GB

Table 8 Available Hot-Pluggable Sled-Mounted Front-Loading Drives (continued)
 (UCSC-C240-M5SX (26-drive system), UCSC-C240-M5S (10-drive system), UCSC-C240-M5N
 (26-drive system with SFF NVMe-only for rear-facing drives))

Product ID (PID)	PID Description	Drive Type	Capacity
UCS-SD150G61X-EV	150 GB 2.5 inch Enterprise Value 6G SATA SSD (Intel S3520)	SATA	150 GB
UCS-SD240G61X-EV	240 GB 2.5 inch Enterprise Value 6G SATA SSD (Samsung PM863A)	SATA	240 GB
UCS-SD240GM1X-EV	240 GB 2.5 inch Enterprise Value 6G SATA SSD (Micron 5100 ECO)	SATA	240 GB
UCS-SD480G61X-EV	480 GB 2.5 inch Enterprise Value 6G SATA SSD (Intel S3520)	SATA	480 GB
UCS-SD480GM1X-EV	480 GB 2.5 inch Enterprise Value 6G SATA SSD (Micron 5100 ECO)	SATA	480 GB
UCS-SD480G121X-EV	480 GB 2.5 inch Enterprise Value 12G SAS SSD (Toshiba PM4)	SATA	480 GB
UCS-SD960G61X-EV	960 GB 2.5 inch Enterprise Value 6G SATA SSD (Samsung PM863A)	SATA	960 GB
UCS-SD960GM1X-EV	960 GB 2.5 inch Enterprise Value 6G SATA SSD (Micron 5100 ECO)	SATA	960 GB
UCS-SD960G121X-EV	960 GB 2.5 inch Enterprise Value 12G SAS SSD (Toshiba PM4)	SATA	960 GB
UCS-SD16T61X-EV	1.6 TB 2.5 inch Enterprise Value 6G SATA SSD (Intel S3520)	SATA	1.6 TB
UCS-SD16TM1X-EV	1.6 TB 2.5 inch Enterprise Value 6G SATA SSD (Micron 5100 ECO)	SATA	1.6 TB
UCS-SD19T61X-EV	1.9 TB 2.5 inch Enterprise Value 6G SATA SSD (Samsung PM863A)	SATA	1.9 TB
UCS-SD19TM1X-EV	1.9 TB 2.5 inch Enterprise Value 6G SATA SSD (Micron 5100 ECO)	SATA	1.9 TB
UCS-SD19TB121X-EV	1.9 TB 2.5 inch Enterprise Value 12G SAS SSD (Toshiba PM4)	SATA	1.9 TB
UCS-SD38T61X-EV	3.8 TB 2.5 inch Enterprise Value 6G SATA SSD (Samsung PM863A)	SATA	3.8 TB
UCS-SD38TM1X-EV	3.8 TB 2.5 inch Enterprise Value 6G SATA SSD (Micron 5100 ECO)	SATA	3.8 TB
UCS-SD38TB121X-EV	3.8 TB 2.5 inch Enterprise Value 12G SAS SSD (Toshiba PM4)	SATA	3.8 TB
UCS-SD76TM1X-EV	7.6 TB 2.5 inch Enterprise Value 6G SATA SSD (Micron 5100 ECO)	SATA	7.6 TB
Self-Encrypted Drives (SED)			
UCS-HD600G15NK9	600 GB 12G SAS 15K RPM SFF HDD (SED)	SAS	600 GB
UCS-HD12G10NK9	1.2 TB 12G SAS 10K RPM SFF HDD (SED)	SAS	1.2 TB
UCS-HD300G10NK9	300 GB 12G SAS 10K RPM SFF HDD (SED)	SAS	300 GB
UCS-SD400GBENK9	400 GB Enterprise performance SAS SSD (10X FWPD, SED)(Micron S650DC)	SAS	400 GB
UCS-SD800GBENK9	800 GB Enterprise performance SAS SSD (10X FWPD, SED)(Micron S650DC)	SAS	800 GB
UCS-SD16TBENK9	1.6 TB Enterprise performance SAS SSD (10X FWPD, SED)(Micron S650DC)	SAS	1.6 TB
PCIe/NVMe SFF 2.5" drives² (Only for the UCSC-C240-M5SN server)			
UCSC-NVMEHW-H800	U.2 800 GB HGST SN200 NVMe High Perf. High Endurance (HGST)	NVMe	800 GB
UCSC-NVMEHW-H1600	U.2 1.6 TB HGST SN200 NVMe High Perf. High Endurance (HGST)	NVMe	1.6 TB
UCSC-NVMEHW-H3200	U.2 3.2 TB HGST SN200 NVMe High Perf. High Endurance (HGST)	NVMe	3.2 TB
UCSC-NVMEHW-H6400	U.2 6.4TB HGST SN200 NVMe High Perf. High Endurance (HGST)	NVMe	6.4 TB
UCSC-NVMEHW-H7680	U.2 7.7 TB HGST SN200 NVMe High Perf. Value Endurance (HGST)	NVMe	7.7 TB

Notes:

1. Operating Systems supported on 4k sector size drives are as follows:

- Windows: Win2012 and Win2012R2
- Linux: RHEL 6.5/6.6/6.7/7.0/7.2/SLES 11 SP3 and SLES 12
- ESXi/VMware does not support 4k format drives; supports only 512e format drives

UEFI Mode must be used when booting from 4K sector size drives, legacy mode is not supported.

Ensure that 4K sector size and 512 byte sector size drives are not mixed in the same RAID volume.

2. Two CPUs must be installed in order to include any number of SFF NVMe PCIe SSDs. If you choose one or two SFF PCIe SSD or SFF NVMe drives, drive slots 1 and 2 at the front of the chassis are reserved for these drives (see [Figure 2 on page 6](#) for drive slot numbering)
3. Targeted for write centric IO applications. Supports endurance of 10 or 3 DWPD (drive writes per day). Target applications are caching, online transaction processing (OLTP), data warehousing, and virtual desktop infrastructure (VDI).
4. Targeted for read centric IO applications. Supports endurance of 1 DWPD (drive write per day). Target applications are boot, streaming media, and collaboration.

Caveats

- You can choose only SATA HDDs when using embedded software RAID. The UCSC-C240-M5SN does not support embedded RAID.
- 2.5-inch SFF NVMe drives are connected directly to the CPU, not managed by the RAID controller.
- You can mix HDDs and SSDs as long as you keep all HDDs in their own RAID volume and all SSDs in their own RAID volume.
- You can mix SAS HDDs and SAS/SATA SSDs when using the Cisco 12G SAS RAID Controller or Cisco 12G SAS HBA.
- If you order any SFF NVMe drives, you must also order two CPUs.
- SFF NVMe drives are bootable in UEFI mode only.
- NVMe HHHH drives are not bootable.
- SED drives can be mixed with the non-SED drives in [Table 8 on page 28](#)

STEP 7 SELECT PCIe OPTION CARD(s)

The standard PCIe card offerings are:

- Modular LAN on Motherboard (MLOM)
- Virtual Interface Cards (VICs)
- Network Interface Cards (NICs)
- Converged Network Adapters (CNAs)
- Host Bus Adapters (HBAs)
- UCS Storage Accelerators

Select PCIe Option Cards

The available PCIe option cards are listed in [Table 9](#).

Table 9 Available PCIe Option Cards

Product ID (PID)	PID Description	Card Height
Modular LAN on Motherboard (mLOM)		
UCSC-MLOM-C40Q-03 ¹	Cisco VIC 1387 dual port 40Gb QSFP CNA MLOM	N/A
UCSC-MLOM-IRJ45	Intel i350 quad port 1G copper MLOM	N/A
Virtual Interface Cards (VICs)		
UCSC-PCIE-C40Q-03 ¹	Cisco VIC 1385 dual port 40Gb QSFP+ CNA w/RDMA	Half
Network Interface Cards (NICs)		
1 Gb NICs		
UCSC-PCIE-IRJ45	Intel i350 quad port 1Gb Adapter	Half
10 Gb NICs		
N2XX-AIPCI01	Intel X520 dual port 10Gb SFP+ Adapter	Half
UCSC-PCIE-ID10GC	Intel X550-T2 dual port 10GBase-T NIC	Half
UCSC-PCIE-ID10GF	Intel X710-DA2 dual port 10G SFP+ NIC	Half
UCSC-PCIE-IQ10GF	Intel X710 quad port 10G SFP+ NIC	Full
40 Gb NIC		
UCSC-PCIE-ID40GF	Intel XL710 dual port 40G QSFP+	Half
Host Bus Adapters (HBAs)		
UCS-PCIE-QD16GF	Ologic QLE2692 dual port 16G Fibre Channel HBA	Half
UCS-PCIE-QD16GF	Emulex LPe31000 dual port 16G Fibre Channel	Half
UCSC-PCIE-QD32GF	Ologic QLE2742 dual port 32G FC HBA	Half
UCSC-PCIE-BS32GF	Emulex LPe32000-M2 single port 32G HBA Emulex	Half
UCSC-PCIE-BD32GF	LPe32002-M2 dual port 32G HBA	Half
UCS NVMe/PCIe Add in Cards		

Table 9 Available PCIe Option Cards (*continued*)

Product ID (PID)	PID Description	Card Height
UCSC-NVME-H12003	Cisco HHL AIC 1.6TB HGST SN260 NVMe Extreme Performance High Endurance	Half
UCSC-NVME-H32003	Cisco HHL AIC 3.2TB HGST SN260 NVMe Extreme Performance High Endurance	Half
UCSC-NVME-H64003	Cisco HHL AIC 6.4TB HGST SN260 NVMe Extreme Performance High Endurance	Half
UCSC-NVME-H38401	Cisco HHL AIC 3.8TB HGST SN260 NVMe Extreme Performance High Endurance	Half
UCSC-NVME-H76801	Cisco HHL AIC 7.7TB HGST SN260 NVMe Extreme Performance Value Endurance	Half

Notes:

- VIC 1385 and 1387 support QSA module (CVR-QSFP-SFP10G)

Caveats

- For 1-CPU systems:
 - Only PCIe slots 1 and 2 on PCIe riser 1A are available for a 1-CPU system. All three slots (1, 2, and 3) on PCIe riser 1B are available for a 1-CPU system. Slots 1, 2, and 3 are to the left when looking at the rear of the server. Slot 1 is the bottom slot.
 - The PCIe slots on riser 2 are not supported on 1-CPU systems. The riser 2 slots are full-height PCIe slots 4, 5, and 6 (see [Figure 4 on page 8](#)). These are the slots on the right when looking at the rear of the server. Slot 4 is the bottom slot.
 - Only a single plug-in PCIe VIC card may be installed on a 1-CPU system, and it must be installed in slot 2 or 1 of riser 1 or 1B.
 - You can order an mLOM VIC card to be installed in the mLOM slot internal to the chassis and thus have two VIC cards in operation at the same time. If you order a GPU, it must be installed in slot 2, See [Table 9 on page 31](#) for the selection of plug-in and mLOM VIC cards. See also [Table 1 on page 10](#) and [Riser Card Configuration and Options, page 92](#) for the PCIe slot physical descriptions.
- For 2-CPU systems:
 - Six PCIe slots are available, three on PCIe riser 1 or riser 1B (PCIe slots 1, 2, and 3) and three on PCIe riser 2A, 2B or 2C (PCIe slots 4, 5, and 6).
 - Two plug-in PCIe VIC cards can be installed in dual CPU systems, using slots 2 and 5. In addition, you can order an mLOM VIC card, which is installed in the mLOM slot inside the chassis and thus have three VIC cards in operation at the same time. See [Table 9 on page 31](#) for the selection of plug-in and mLOM VIC cards. See also [Table 1 on page 10](#) and [Riser Card Configuration and Options, page 92](#) for the PCIe slot physical descriptions.
 - If GPUs are installed in slots 2 (Riser 1 or 1B) and 5 (Riser 2A or 2B), the NCSI capability automatically switches over to slots 1 (Riser 1 or 1B) and 4 (Riser 2A or 2B). Therefore, Cisco PCIe VICs can be installed in slots 1 and 4 if GPUs are installed

in slots 2 and 5. If you order two GPUs, they must be installed in slots 2 and 5 and thus you will not be able to install VIC cards in those slots.



NOTE: UCSM managed servers are discoverable only if a VIC is installed in slot 2 or a VIC is installed in the MLOM slot. If you install two GPUs, they must be located in slots 2 and 5. Therefore, if two GPUs are installed, UCSM managed servers are discoverable only if you install a VIC in the MLOM slot.

- The server supports up to two PCIe Cisco VICs plus an MLOM VIC

However, single wire management is supported on only one VIC at a time. If multiple VICs are installed on a server, only one slot has NCSI enabled at a time and for single wire management, priority goes to the MLOM slot, then slot 2, then slot 5 for NCSI management traffic. When multiple cards are installed, connect the single wire management cables in the priority order mentioned above.

- To help ensure that your operating system is compatible with the card you have selected, or to see additional cards that have been qualified to work with the UCS C240 M5 server, but are not sold on the Cisco price list, check the Hardware Compatibility List at this

URL: http://www.cisco.com/en/US/products/ps10477/prod_technical_reference_list.html

STEP 8 ORDER GPU CARDS (OPTIONAL)

Select GPU Options

The available GPU PCIe options are listed in [Table 10](#).

Table 10 Available PCIe GPU Cards

Product ID (PID)	PID Description	Card Size
GPU PCIe Cards		
UCSC-GPU-M10	NVIDIA M10 GPU	Doublewide (consumes 2 slots)
UCSC-GPU-P40	NVIDIA P40	Doublewide (consumes 2 slots)
UCSC-GPU-P100-12G	NVIDIA P100 12GB	Doublewide (consumes 2 slots)
UCSC-GPU-P100-16G	NVIDIA P100 16GB	Doublewide (consumes 2 slots)
UCSC-GPU-7150x2	AMD Firepro 7150x2	Doublewide (consumes 2 slots)



CAUTION: When using the GPU cards, The maximum allowable operating temperature for NVIDIA P40 GPU is 32oC (89oF) and NVIDIA P100 GPU is 28oC (82oF)



NOTE: All GPU cards must be procured from Cisco as there is a unique SBIOS ID required by CIMC and UCSM

NOTE: All GPU cards require two CPUs and a minimum of two power supplies in the server. 1600 W power supplies are recommended. Use the power calculator at the following link to determine the needed power based on the options chosen (CPUs, drives, memory, and so on):

<http://ucspowercalc.cisco.com>

Caveats

- NVIDIA M10 GPUs can support only less than 1 TB of total memory in the server. Do not install more than fourteen 64-GB DIMMs when using an NVIDIA GPU card in this server.
- GPUs cannot be mixed.
- Slot 5 on riser card 2 is the required slot for the first GPU.
- Slot 2 on riser card 1 is the secondary slot for a second GPU.

Refer to [Table 11](#) for the PCIe slot usage for the following PCIe cards installed in riser 1 and riser 2:

- External RAID
- VIC
- NIC
- HBA
- GPU
- NVMe HDDL.

Table 11 PCIe Slot Usage in Riser 1 (slots 1, 2, 3) and Riser 2 (slots 4, 5, 6)

Riser Combinations	Total Riser Slots Available		Riser Slots Available for GPUs	
	1-CPU System	2-CPU System	1-CPU System	2-CPU System
1A only	Slots 1 and 2	Slots 1, 2, and 3	Slot 2	Slot 2
1B only	Slots 1, 2, and 3	Slots 1, 2, and 3	None	None
1A and 2A	Slots 1 and 2	Slots 1, 2, 3, 4, 5, and 6	Slot 2	Slots 2 and 5
1A and 2B	Slots 1 and 2	Slots 1, 2, 3, 4, 5, and 6	Slot 2	Slots 2 and 5
1A and 2C	Slots 1 and 2	Slots 1, 2, 3, 4, 5, and 6	Slot 2	Slot 2
1A and 2D	Slots 1 and 2	Slots 1, 2, 3, 4, 5, and 6	Slot 2	Slot 2
1B and 2A	Slots 1 and 2	Slots 1, 2, 3, 4, 5, and 6	None	Slot 5
1B and 2B	Slots 1 and 2	Slots 1, 2, 3, 4, 5, and 6	None	Slot 5
1B and 2C	Slots 1 and 2	Slots 1, 2, 3, 4, 5, and 6	None	None
1B and 2D	Slots 1 and 2	Slots 1, 2, 3, 4, 5, and 6	None	None



NOTE: UCSM managed servers are discoverable only if a PCIe VIC card is installed in slot 2 or an mLOM VIC card is installed in the mLOM slot. If you install two GPUs, they must be located in slots 2 and 5. Therefore, if two GPUs are installed, UCSM managed servers are discoverable only if you install a VIC in the MLOM slot.



NOTE: For more information on the riser card options, see [Riser Card Configuration and Options, page 72](#).

STEP 9 ORDER POWER SUPPLY

Power supplies share a common electrical and physical design that allows for hot-plug and tool-less installation into M5 C-series servers. Each power supply is certified for high-efficiency operation and offer multiple power output options. This allows users to "right-size" based on server configuration, which improves power efficiency, lower overall energy costs and avoid stranded capacity in the data center. Use the power calculator at the following link to determine the needed power based on the options chosen (CPUs, drives, memory, and so on):

<http://ucspowercalc.cisco.com>

Table 12 Power Supply

Product ID (PID)	PID Description
UCSC-PSU1-1050W	1050W AC power supply for C-Series servers
UCSC-PSUV2-1050DC	1050W DC power supply for C-Series servers
UCSC-PSU1-1600W	1600W power supply for C-Series servers



NOTE: In a two power supply server, both power supplies must be identical.

STEP 10 SELECT INPUT POWER CORD(S)

Using [Table 13](#), select the appropriate AC power cords. You can select a minimum of no power cords and a maximum of two. If you select the option R2XX-DMYMPWRCORD, no power cord is shipped with the server.

Table 13 Available Power Cords

Product ID (PID)	PID Description	Images
R2XX-DMYMPWRCORD	No power cord (dummy PID to allow for a no power cord option)	Not applicable
CAB-48DC-40A-8AWG	C-Series -48VDC PSU Power Cord, 3.5M, 3 Wire, 8AWG, 40A	 <p>Figure 1-3 CAB-48DC-40A-8AWG DC Power Cord (3.5 m)</p> <p>Plug: 40A, 3W, 48VDC, 8AWG</p> <p>Cable: 3W, 48VDC, 8AWG</p> <p>Length: 3.5 m</p> <p>Back Panel: 3.5 m</p>
CAB-N5K6A-NA	Power Cord, 200/240V 6A, North America	 <p>Plug: NEMA 6-15P</p> <p>Cordset rating: 10 A, 250 V</p> <p>Length: 8.2 ft</p> <p>Connector: IEC60320/C13</p>
CAB-AC-L620-C13	AC Power Cord, NEMA L6-20 - C13, 2M/6.5ft	 <p>79in/2m</p> <p>79in/2m</p>
CAB-C13-CBN	CABASY,WIRE,JUMPER CORD, 27" L, C13/C14, 10A/250V	 <p>27" L</p>
CAB-C13-C14-2M	CABASY,WIRE,JUMPER CORD, PWR, 2 Meter, C13/C14,10A/250V	 <p>2 Meter</p>

Table 13 Available Power Cords

Product ID (PID)	PID Description	Images
CAB-C13-C14-AC	CORD,PWR,JMP,IEC60320/C14,IEC60320/C13, 3.0M	
CAB-250V-10A-AR	Power Cord, 250V, 10A, Argentina	
CAB-9K10A-AU	Power Cord, 250VAC 10A 3112 Plug, Australia	
CAB-250V-10A-CN	AC Power Cord - 250V, 10A - PRC	
CAB-9K10A-EU	Power Cord, 250VAC 10A CEE 7/7 Plug, EU	
CAB-250V-10A-ID	Power Cord, SFS, 250V, 10A, India	
CAB-250V-10A-IS	Power Cord, SFS, 250V, 10A, Israel	

Table 13 Available Power Cords

Product ID (PID)	PID Description	Images
CAB-9K10A-IT	Power Cord, 250VAC 10A CEI 23-16/VII Plug, Italy	<p>Plug: 1/3G (CEI 23-16)</p> <p>Cordset rating: 10 A, 250 V Length: 8 ft 2 in (2.5 m)</p> <p>Connector: C15M (EN60320/C15)</p>
CAB-9K10A-SW	Power Cord, 250VAC 10A MP232 Plug, Switzerland	<p>Plug: MP232-R</p> <p>Cordset rating: 10 A, 250 V Length: 8 ft 2 in (2.5 m)</p> <p>Connector: IEC 60320 C15</p>
CAB-9K10A-UK	Power Cord, 250VAC 10A BS1363 Plug (13 A fuse), UK	<p>Cordset rating: 10 A, 250 V/500 V MAX Length: 2500mm</p> <p>Plug: EL 210 (BS 1363A) 13 AMP fuse</p> <p>Connector: EL 701 C (EN 60320/C15)</p>
CAB-9K12A-NA	Power Cord, 125VAC 13A NEMA 5-15 Plug, North America	<p>Cordset rating: 13A, 125V (8.2 Nm) (2.5m)</p> <p>Plug: NEMA 5-15P</p> <p>Connector: IEC60320/C15</p>
CAB-250V-10A-BR	Power Cord - 250V, 10A - Brazil	<p>2,133 x 25</p>
CAB-C13-C14-2M-JP	Power Cord C13-C14, 2M/6.5ft Japan PSE mark	Image not available

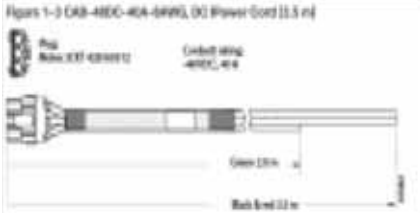
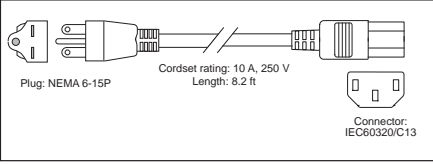
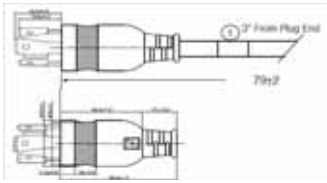
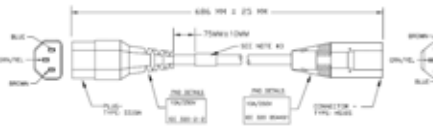
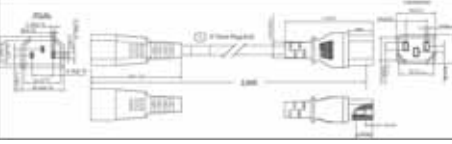
Table 13 Available Power Cords

Product ID (PID)	PID Description	Images
CAB-AC-16A-AUS	16A, 250 VAC, Australia	
UCSB-CABL-C19-BRZ	16A, 250 VAC, Brazil	
CAB-AC16A-CH	16A, 250 VAC, China	
CAB-AC-2500W-EU	16A, 250 VAC, Europe	
CAB-AC-2500W-INT	16A, 250 VAC, International	
CAB-AC-2500W-ISRL	16A, 250 VAC, Israel	
CAB-US620P-C19-US	16A, 250 VAC, NEMA 6-20P	
CAB-AC-C6K-TWLK	20A, 250 VAC (twist-lock), NEMA L6-20	
CAB-ACS-16	16A, 250 VAC, Switzerland	
CAB-C19-CBN	16A, 250 VAC, Jumper cord C19/C20	
CAB-US515P-C19-US	15A, 125 VAC NEMA 5-15 to IEC-C19 13ft USA	
CAB-US520-C19-US	20A, 125 VAC NEMA 5-20 to IEC-C19 14ft USA	

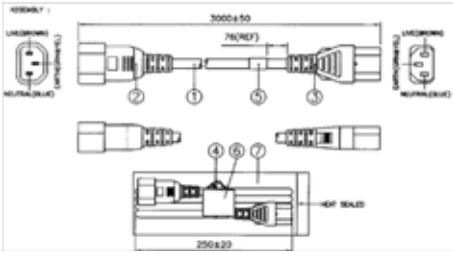
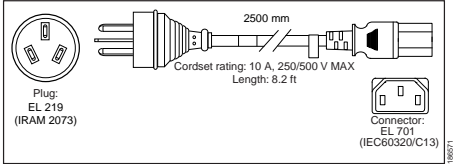
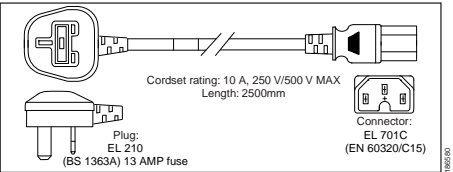
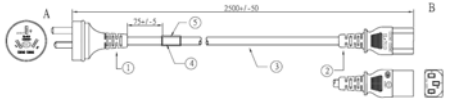
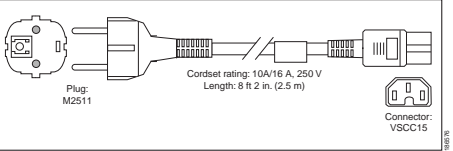
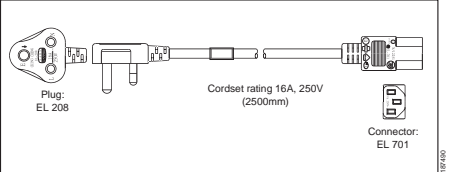
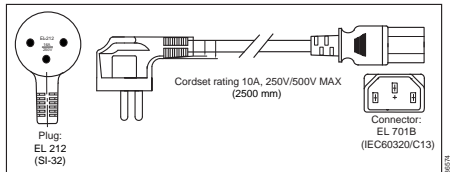
STEP 11 ORDER TOOL-LESS RAIL KIT AND OPTIONAL REVERSIBLE CABLE MANAGEMENT ARM

Select a Tool-less Rail Kit

Select a tool-less rail kit from [Table 14](#).

Table 14 Tool-less Rail Kit Options

Product ID (PID)	PID Description
UCSC-RAILB-M4	Ball Bearing Rail Kit for C220 and C240M4/M5 Rack Servers
UCSC-RAIL-NONE	No rail kit option

Select an Optional Reversible Cable Management Arm

The reversible cable management arm mounts on either the right or left slide rails at the rear of the server and is used for cable management. Use [Table 15](#) to order a cable management arm.

Table 15 Cable Management Arm

Product ID (PID)	PID Description
UCSC-CMA-M4	Reversible CMA for tool-less C220/C240 M4/M5 ball bearing rail kit

For more information about the tool-less rail kit and cable management arm, see the *Cisco UCS C240 M5 Installation and Service Guide* at this URL:

http://www.cisco.com/c/en/us/td/docs/unified_computing/ucs/c/hw/C240M4/install/C240M4.html



NOTE: If you plan to rackmount your UCS C240 M5 server, you must order a tool-less rail kit. The same rail kits and CMA's are used for C240 M4 and C240 M5 servers.

STEP 12 SELECT MANAGEMENT CONFIGURATION (OPTIONAL)

By default, the C240 M5 server NIC mode is configured to be Shared LOM Extended. This NIC mode allows any LOM port or adapter card port to be used to access the Cisco Integrated Management Controller (CIMC). The Cisco VIC card must be installed in a slot with NCSI support.

To change the default NIC mode to Dedicated, select the UCSC-DLOM-01 PID shown in [Table 16](#). In Dedicated NIC mode, the CIMC can be accessed only through the dedicated management port. See [Chassis Rear View, page 8](#) for the location of the management port.

To change the default NIC mode to Cisco Card Mode, select the UCSC-CCARD-01 PID shown in [Table 16](#). In this mode, you can assign an IP address to the CIMC using DHCP and from there you can fully automate your deployment.

For more details on all the NIC mode settings, see

http://www.cisco.com/c/en/us/td/docs/unified_computing/ucs/c/sw/gui/config/guide/2-0/b_Cisco_UCS_C-series_GUI_Configuration_Guide_201.pdf

Table 16 Management Configuration Ordering Information

Product ID (PID)	PID Description
UCSC-DLOM-01	Dedicated Mode BIOS setting for C-Series Servers
UCSC-CCARD-01	Cisco Card Mode BIOS setting for C-Series Servers

STEP 13 SELECT SERVER BOOT MODE (OPTIONAL)

By default, the C240 M5 server will ship with UEFI as the default boot mode. To have a server shipped with the Legacy BIOS mode (which was standard on M4 and previous generation servers), select the Legacy BIOS PID.

Table 17 Server Boot Mode Ordering Information

Product ID (PID)	PID Description
UCSC-LBIOS-01	Legacy Boot Mode BIOS setting for C-Series Servers

STEP 14 SELECT LOCKING SECURITY BEZEL (OPTIONAL)

An optional locking bezel can be mounted to the front of the chassis to prevent unauthorized access to the drives.

Select the locking bezel from [Table 18](#).

Table 18 Locking Bezel Option

Product ID (PID)	Description
UCSC-BZL-C240M5	C240 M5 Security Bezel

STEP 15 ORDER SECURITY DEVICES (OPTIONAL)

A Trusted Platform Module (TPM) is a computer chip (microcontroller) that can securely store artifacts used to authenticate the platform (server). These artifacts can include passwords, certificates, or encryption keys. A TPM can also be used to store platform measurements that help ensure that the platform remains trustworthy. Authentication (ensuring that the platform can prove that it is what it claims to be) and attestation (a process helping to prove that a platform is trustworthy and has not been breached) are necessary steps to ensure safer computing in all environments.

A chassis intrusion switch gives a notification of any unauthorized mechanical access into the server.

The security device ordering information is listed in [Table 19](#).

Table 19 Security Devices

Product ID (PID)	PID Description
UCSX-TPM2-001	Trusted Platform Module 1.2 SPI-based for UCS Servers
UCSX-TPM2-002	Trusted Platform Module 2.0 for UCS servers
UCSC-INT-SW01 ¹	C220 M5 and C240 M5 Chassis Intrusion Switch

Notes:

1. Available later in CY 2017.



NOTE: The TPM module used in this system conforms to TPM v1.2 and 2.0, as defined by the Trusted Computing Group (TCG). It is also SPI-based.



NOTE: NOTE: TPM installation is supported after-factory. However, a TPM installs with a one-way screw and cannot be replaced, upgraded, or moved to another server. If a server with a TPM is returned, the replacement server must be ordered with a new TPM.

STEP 16 ORDER OPTICAL DRIVE (OPTIONAL)

Order an optical drive (DVD). See [Table 20](#).

Table 20 Optical (DVD) Drive

Product ID (PID)	PID Description
UCSC-DVD-C240M5	Media Drive (DVD) for C240 M5 Servers (8-HDD version only)

Caveats

You can order a DVD drive only for the UCSC-C240-M5S (8-HDD backplane version of the server).

STEP 17 ORDER CISCO SD CARD MODULE (OPTIONAL)

Order SD cards. See [Figure 6 on page 67](#) for the location of the SD cards. There are two locations, SD1 and SD2.

Table 21 128 GB Secure Digital (SD) Card (blank)

Product ID (PID)	PID Description
UCS-SD-128G	128 GB SD Card for UCS Servers
UCS-SD-64G-S	64 GB SD Card for UCS Servers
UCS-SD-32G-S	32 GB SD Card for UCS Servers

Caveats

- Install either one or two SD cards
- Do not mix SD card sizes
- You cannot mix SD cards with an internal M.2 SATA SSD (see [ORDER M.2 SATA SSD \(OPTIONAL\), page 48](#)).

STEP 18 ORDER M.2 SATA SSD (OPTIONAL)

Order one or two matching capacity M.2 SATA SSDs as desired.

Table 22 M.2 SATA SSDs

Product ID (PID)	PID Description
UCS-M2-240GB	240 GB M.2 SATA SSD
UCS-M2-960GB	960 GB M.2 SATA SSD

Caveats

- Install either one or two M.2 SATA SSDs.
- You cannot mix M.2 SATA SSDs with SD cards (see [ORDER CISCO SD CARD MODULE \(OPTIONAL\), page 47](#)).
- When Ordering two M.2 devices with embedded software RAID with the UCSC-C240-M5S server PID, the maximum number of internal SATA drives supported is six. To support greater than 6 internal drives a Cisco 12G Raid Controller or 12G SAS HBA must be ordered

STEP 19 ORDER INTERNAL MICRO-SD CARD MODULE (OPTIONAL)

Order a 32 GB micro-SD card.

The micro-SD card serves as a dedicated local resource for utilities such as HUU. Images can be pulled from a files hare (NFS/CIFS) and uploaded to the cards for future use.

Table 23 32 GB Secure Digital (SD) Card (blank)

Product ID (PID)	PID Description
UCS-MSD-32G	32GB Micro-SD Card for UCS servers

Caveats

- The microSD card mounts internally on riser 1 or riser 1B, so you must order either UCSC-PCI-1-C240M5 or UCSC-PCI-1B-C240M5 when you order a micro-SD card.

STEP 20 ORDER OPTIONAL USB 3.0 DRIVE

You can order one optional USB 3.0 drive. The USB drive ordering information is listed in [Table 24](#).

Table 24 USB 3.0 Drive

Product ID (PID)	PID Description
UCS-USBFLSHB-16GB	UCS Servers 16 GB Flash USB Drive

See [Figure 6 on page 67](#) for the location of the USB connector

STEP 21 SELECT OPERATING SYSTEM AND VALUE-ADDED SOFTWARE

For more details on supported operating systems and software for this server, see the Hardware & Software Compatibility List (HCL).

NOTE: PIDs tagged with an asterisk (*) are Resell of an OEM Vendor's Support. They are required to be added to the associated Product License PID.

Table 25 Software (for 2-CPU servers)

Product ID (PID)	PID Description
Cisco One	
C1F2PUCSK9	Cisco ONE Foundation Perpetual UCS
C1A1PUCSK9	Cisco ONE Enterprise Cloud Perpetual UCS
C1UCS-OPT-OUT	Cisco One Data Center Compute Opt Out Option
Energy Management (JouleX)	
CEM-DC-ENERGY	Cisco Energy Management (JouleX) Data Center License 1 Device
CEM-DC-3Y*	Cisco Energy Management-3 Yr for One DC physical end-device
CEM-DC-PER	Perpetual License Key for Cisco Energy Management for DC
UCS Director	
CUIC-PHY-SERV-BM-U	Cisco UCS Director Resource Lic - 1 Phy Sevr node bare metal
CUIC-PHY-SERV-U	Cisco UCS Director Resource Lic - One physical Server node
CUIC-TERM	Acceptance of Cisco UCS Director License Terms
UCS Performance Manager	
UCS-PM-IE	UCS Performance Manager
UCS-PM-EE	UCS Performance Manager Express
EVAL-UCS-PM-IE	UCS Performance Manager - 90 days evaluation
EVAL-UCS-PM-EE	UCS Performance Manager Express - 90 days evaluation
Nexus 1000V for Hyper-V and vSphere	
N1K-VSG-UCS-BUN	Nexus 1000V Adv Edition for vSphere Paper License Qty 1
IMC Supervisor	
CIMC-SUP-BASE-K9	IMC Supervisor One-time Site Installation License
CIMC-SUP-B01	IMC Supervisor-Branch Mgt SW for C-Series & E-Series upto 100 Svrs
CIMC-SUP-B02	IMC Supervisor- Branch Mgt SW for C & E-Series up to 250 Svrs
CIMC-SUP-B10	IMC Supervisor- Branch Mgt SW for C & E-Series up to 1K Svrs
CIMC-SUP-B25	IMC Supervisor Branch Mgt SW for C & E-Series 25 Svrs
CIMC-SUP-A01	IMC Supervisor Adv-Branch Mgt SW for C & E-Series 100 Svrs
CIMC-SUP-A02	IMC Supervisor Adv-Branch Mgt SW for C & E-Series 250 Svrs
CIMC-SUP-A10	IMC Supervisor Adv-Branch Mgt SW for C & E-Series 1000 Svrs
CIMC-SUP-A25	IMC Supervisor Adv-Branch Mgt SW for C & E-Series 250 Svrs
CIMC-SUP-TERM	Acceptance of Cisco IMC Supervisor License Terms
UCS Multi-Domain Manager	

Table 25 Software (for 2-CPU servers)

UCS-MDMGR-1S	UCS Central Per Server License NOTE: IF you must order quantity greater than 1 of UCS-MDMGR-1S, you need to reference the UCS Central Per Server Data Sheet to order the standalone PIDs: UCS-MDMGR-LIC= or UCS-MDMGR-1DMN=
VMware vCenter	
VMW-VCS-STD-1A	VMware vCenter 6 Server Standard, 1 yr support required
VMW-VCS-STD-3A	VMware vCenter 6 Server Standard, 3 yr support required
VMW-VCS-STD-5A	VMware vCenter 6 Server Standard, 5 yr support required
VMW-VCS-FND-1A	VMware vCenter 6 Server Foundation (3 Host), 1 yr supp reqd
VMW-VCS-FND-3A	VMware vCenter 6 Server Foundation (3 Host), 3 yr supp reqd
VMW-VCS-FND-5A	VMware vCenter 6 Server Foundation (3 Host), 5 yr supp reqd
Microsoft Windows Server	
MSWS-12R2-DC2S	Windows Server 2012 R2 Datacenter (2 CPU/Unlimited VMs)
MSWS-12R2-DC2S-NS	Windows Server 2012 R2 Datacen (2 CPU/Unlim VM) No Cisco Svc
MSWS-12R2-ST2S	Windows Server 2012 R2 Standard (2 CPU/2 VMs)
MSWS-12R2-ST2S-NS	Windows Server 2012 R2 Standard (2 CPU/2 VMs) No Cisco SVC
MSWS-12R2-ST2S-RM	Windows Server 2012 R2 Standard (2 CPU/2 VMs) Recovery Media
MSWS-12R2-DC2S-RM	Windows Server 2012 R2 Datacen(2 CPU/Unlimited VM) Rec Media
MSWS-16-ST16C	Windows Server 2016 Standard (16 Cores/2 VMs)
MSWS-16-ST24C	Windows Server 2016 Standard (24 Cores/2 VMs)
MSWS-16-ST16C-NS	Windows Server 2016 Standard (16 Cores/2 VMs) - No Cisco SVC
MSWS-16-ST24C-NS	Windows Server 2016 Standard (24 Cores/2 VMs) - No Cisco SVC
MSWS-16-DC16C	Windows Server 2016 Data Center (16 Cores/Unlimited VMs)
MSWS-16-DC24C	Windows Server 2016 Data Center (24 Cores/Unlimited VMs)
MSWS-16-DC16C-NS	Windows Server 2016 DC (16 Cores/Unlim VMs) - No Cisco SVC
MSWS-16-DC24C-NS	Windows Server 2016 DC (24 Cores/Unlim VMs) - No Cisco SVC
MSWS-16-STA2C	Windows Server 2016 Standard - Additional 2 Cores
MSWS-16-STA4C	Windows Server 2016 Standard - Additional 4 Cores
MSWS-16-STA16C	Windows Server 2016 Standard - Additional 16 Cores
MSWS-16-STA2C-NS	Windows Server 2016 Stan - Additional 2 Cores - No Cisco SVC
MSWS-16-STA4C- NS	Windows Server 2016 Stan - Additional 4 Cores - No Cisco SVC
MSWS-16-STA16C-NS	Windows Server 2016 Stan - Additional 16 Cores - No Cisco SVC
MSWS-16-DCA2C	Windows Server 2016 Data Center - Additional 2 Cores
MSWS-16-DCA4C	Windows Server 2016 Data Center - Additional 4 Cores
MSWS-16-DCA16C	Windows Server 2016 Data Center - Additional 16 Cores
MSWS-16-DCA2C-NS	Windows Server 2016 DC - Additional 2 Cores - No Cisco SVC
MSWS-16-DCA4C-NS	Windows Server 2016 DC - Additional 4 Cores - No Cisco SVC
MSWS-16-DCA16C-NS	Windows Server 2016 DC - Additional 16 Cores - No Cisco SVC
Red Hat	
RHEL-2S2V-1A	Red Hat Enterprise Linux (1-2 CPU,1-2 VN); 1-Yr Support Req
RHEL-2S2V-3A	Red Hat Enterprise Linux (1-2 CPU,1-2 VN); 3-Yr Support Req
RHEL-2S-HA-1A	RHEL High Availability (1-2 CPU); 1-Yr Support Reqd
RHEL-2S-HA-3A	RHEL High Availability (1-2 CPU); 3-Yr Support Reqd

Table 25 Software (for 2-CPU servers)

RHEL-2S-RS-1A	RHEL Resilient Storage (1-2 CPU); 1-Yr Support Reqd
RHEL-2S-RS-3A	RHEL Resilient Storage (1-2 CPU); 3-Yr Support Reqd
RHEL-2S-SFS-1A	RHEL Scalable File System (1-2 CPU); 1-Yr Support Reqd
RHEL-2S-SFS-3A	RHEL Scalable File System (1-2 CPU); 3-Yr Support Reqd
RHEL-2S2V-1S	Red Hat Enterprise Linux (1-2 CPU,1-2 VN); Prem 1-Yr SnS
RHEL-2S2V-1YR*	Red Hat Enterprise Linux (1-2 CPU,1-2 VN);Premium 24x7 - 1Yr
RHEL-2S2V-3S	Red Hat Enterprise Linux (1-2 CPU,1-2 VN); Prem 3-Yr SnS
RHEL-2S2V-3YR*	Red Hat Enterprise Linux (1-2 CPU,1-2 VN);Premium 24x7 - 3Yr
RHEL-2S-HA-1S	RHEL High Availability (1-2 CPU); Premium 1-yr SnS
RHEL-2S-HA-1YR*	RHEL High Availability (1-2 CPU); Premium 24x7 - 1 Year
RHEL-2S-HA-3S	RHEL High Availability (1-2 CPU); Premium 3-yr SnS
RHEL-2S-HA-3YR*	RHEL High Availability (1-2 CPU); Premium 24x7 - 3 Year
RHEL-2S-RS-1S	RHEL Resilient Storage (1-2 CPU); Premium 1-yr SnS
RHEL-2S-RS-1YR*	RHEL Resilient Storage (1-2 CPU); Premium 24x7 - 1 Year
RHEL-2S-RS-3S	RHEL Resilient Storage (1-2 CPU); Premium 3-yr SnS
RHEL-2S-RS-3YR*	RHEL Resilient Storage (1-2 CPU); Premium 24x7 - 3 Year
RHEL-2S-SFS-1S	RHEL Scalable File System (1-2 CPU); Premium 1-yr SnS
RHEL-2S-SFS-1YR*	RHEL Scalable File System (1-2 CPU); Premium 24x7 - 1 Year
RHEL-2S-SFS-3S	RHEL Scalable File System (1-2 CPU); Premium 3-yr SnS
RHEL-2S-SFS-3YR*	RHEL Scalable File System (1-2 CPU); Premium 24x7 - 3 Year
Red Hat SAP	
RHEL-SAPH-PR-1YR	RHEL for SAP Applications - Premium - RH SnS 1 Yr - 2 Socket
RHEL-SAPH-PR-3YR	RHEL for SAP Applications - Premium - RH SnS 3 Yr - 2 Socket
RHEL-SAPH-ST-1YR	RHEL for SAP Applications - Standard - RH SnS 1 Yr -2 Socket
RHEL-SAPH-ST-3YR	RHEL for SAP Applications - Standard - RH SnS 3 Yr -2 Socket
RHEL-SAP-2S2V-1S	RHEL for SAP Apps (1-2 CPU, 1-2 VN); Prem 1-Yr SnS
RHEL-SAP-2S2V-1YR*	RHEL for SAP Apps (1-2 CPU, 1-2 VN); Premium 24x7 - 1-Yr
RHEL-SAP-2S2V-3S	RHEL for SAP Apps (1-2 CPU, 1-2 VN); Prem 3-Yr SnS
RHEL-SAP-2S2V-3YR*	RHEL for SAP Apps (1-2 CPU, 1-2 VN); Premium 24x7 - 3-Yr
RHEL-SAPH-2S2V-1S	RHEL for SAP Hana (1-2 CPU, 1-2 VN); Prem 1-Yr SnS
RHEL-SAPH-2S2V-1YR*	RHEL for SAP Hana (1-2 CPU, 1-2 VN); Premium 24x7 - 1-Yr
RHEL-SAPH-2S2V-3S	RHEL for SAP Hana (1-2 CPU, 1-2 VN); Prem 3-Yr SnS
RHEL-SAPH-2S2V-3YR*	RHEL for SAP Hana (1-2 CPU, 1-2 VN); Premium 24x7 - 3-Yr
RHEL-SAPHHAS2S-1S	RHEL for SAP Hana,HA,SmartM (1-2 CPU & VN); Std 1Yr SnS Reqd
RHEL-SAPHHAS2S-1YR*	RHEL for SAP Hana,HA,SmartM (1-2 CPU & VN); Std 5x9 1Yr SnS
RHEL-SAPHHAS2S-3S	RHEL for SAP Hana,HA,SmartM (1-2 CPU & VN); Std 3Yr SnS Reqd
RHEL-SAPHHAS2S-3YR*	RHEL for SAP Hana,HA,SmartM (1-2 CPU & VN); Std 5x9 3Yr SnS
RHEL-SAPHHAP2S-1S	RHEL for SAP Hana,HA,SmartM (1-2 CPU &VN); Prem 1Yr SnS Reqd
RHEL-SAPHHAP2S-1YR*	RHEL for SAP Hana,HA,SmartM(1-2 CPU/VN); Prem 24x7 1Yr SnS
RHEL-SAPHHAP2S-3S	RHEL for SAP Hana,HA,SmartM (1-2 CPU &VN); Prem 3Yr SnS Reqd
RHEL-SAPHHAP2S-3YR*	RHEL for SAP Hana,HA,SmartM(1-2 CPU/VN); Prem 24x7 3Yr SnS
VMware	

Table 25 Software (for 2-CPU servers)

VMW-VSP-STD-1A	VMware vSphere 6 Standard (1 CPU), 1-yr, Support Required
VMW-VSP-STD-3A	VMware vSphere 6 Standard (1 CPU), 3-yr, Support Required
VMW-VSP-STD-5A	VMware vSphere 6 Standard (1 CPU), 5-yr, Support Required
VMW-VSP-EPL-3A	VMware vSphere 6 Ent Plus (1 CPU), 3-yr, Support Required
VMW-VSP-EPL-1A	VMware vSphere 6 Ent Plus (1 CPU), 1-yr, Support Required
VMW-VSP-EPL-5A	VMware vSphere 6 Ent Plus (1 CPU), 5-yr, Support Required
SLES and SAP	
SLES-SAP-2S2V-1A	SLES for SAP Apps (1-2 CPU, 1-2 VM); 1-Yr Support Reqd
SLES-SAP-2SUV-1A	SLES for SAP Apps (1-2 CPU, Unl VM); 1-Yr Support Reqd
SLES-SAP-2S2V-3A	SLES for SAP Apps (1-2 CPU, 1-2 VM); 3-Yr Support Reqd
SLES-SAP-2SUV-3A	SLES for SAP Apps (1-2 CPU, Unl VM); 3-Yr Support Reqd
SLES-SAP-2S2V-5A	SLES for SAP Apps (1-2 CPU, 1-2 VM); 5-Yr Support Reqd
SLES-SAP-2SUV-5A	SLES for SAP Apps (1-2 CPU, Unl VM); 5-Yr Support Reqd
SLES-SAP-2S2V-1S	SLES for SAP Apps (1-2 CPU, 1-2 VM); Priority 1-Yr SnS
SLES-SAP-2S2V-1YR*	SUSE for SAP Apps; (1-2 CPU, 1-2 VM); Prio SnS 24x7 - 1 Year
SLES-SAP-2SUV-1S	SLES for SAP Apps (1-2 CPU, Unl VM); Priority 1-Yr SnS
SLES-SAP-2SUV-1YR*	SUSE for SAP Apps; (1-2 CPU, Unl VM); Prio SnS 24x7 - 1 Year
SLES-SAP-2S2V-3S	SLES for SAP Apps (1-2 CPU, 1-2 VM); Priority 3-Yr SnS
SLES-SAP-2S2V-3YR*	SUSE for SAP Apps; (1-2 CPU, 1-2 VM); Prio SnS 24x7 - 3 Year
SLES-SAP-2SUV-3S	SLES for SAP Apps (1-2 CPU, Unl VM); Priority 3-Yr SnS
SLES-SAP-2SUV-3YR*	SUSE for SAP Apps; (1-2 CPU, Unl VM); Prio SnS 24x7 - 3 Year
SLES-SAP-2S2V-5S	SLES for SAP Apps (1-2 CPU, 1-2 VM); Priority 5-Yr SnS
SLES-SAP-2S2V-5YR*	SUSE for SAP Apps; (1-2 CPU, 1-2 VM); Prio SnS 24x7 - 5 Year
SLES-SAP-2SUV-5S	SLES for SAP Apps (1-2 CPU, Unl VM); Priority 5-Yr SnS
SLES-SAP-2SUV-5YR*	SUSE for SAP Apps; (1-2 CPU, Unl VM); Prio SnS 24x7 - 5 Year
SUSE	
SLES-2S2V-1A	SUSE Linux Enterprise Svr (1-2 CPU, 1-2 VM); 1-Yr Support Req
SLES-2SUV-1A	SUSE Linux Enterprise Svr (1-2 CPU, Unl VM); 1-Yr Support Req
SLES-2S2V-3A	SUSE Linux Enterprise Svr (1-2 CPU, 1-2 VM); 3-Yr Support Req
SLES-2SUV-3A	SUSE Linux Enterprise Svr (1-2 CPU, Unl VM); 3-Yr Support Req
SLES-2S2V-5A	SUSE Linux Enterprise Svr (1-2 CPU, 1-2 VM); 5-Yr Support Req
SLES-2SUV-5A	SUSE Linux Enterprise Svr (1-2 CPU, Unl VM); 5-Yr Support Req
SLES-2S2V-1S	SUSE Linux Enterprise Svr (1-2 CPU, 1-2 VM); Prio 1-Yr SnS
SLES-2S2V-1YR*	SUSE Linux Entp Svr (1-2 CPU, 1-2 VM); Prio SnS 24x7 - 1 Year
SLES-2SUV-1S	SUSE Linux Enterprise Svr (1-2 CPU, Unl VM); Prio 1-Yr SnS
SLES-2SUV-1YR*	SUSE Linux Entp Svr (1-2 CPU, Unl VM); Prio SnS 24x7 - 1 Year
SLES-2S2V-3S	SUSE Linux Enterprise Svr (1-2 CPU, 1-2 VM); Prio 3-Yr SnS
SLES-2S2V-3YR*	SUSE Linux Entp Svr (1-2 CPU, 1-2 VM); Prio SnS 24x7 - 3 Year
SLES-2SUV-3S	SUSE Linux Enterprise Svr (1-2 CPU, Unl VM); Prio 3-Yr SnS
SLES-2SUV-3YR*	SUSE Linux Entp Svr (1-2 CPU, Unl VM); Prio SnS 24x7 - 3 Year
SLES-2S2V-5S	SUSE Linux Enterprise Svr (1-2 CPU, 1-2 VM); Prio 5-Yr SnS
SLES-2S2V-5YR*	SUSE Linux Entp Svr (1-2 CPU, 1-2 VM); Prio SnS 24x7 - 5 Year

Table 25 Software (for 2-CPU servers)

SLES-2SUV-5S	SUSE Linux Enterprise Svr (1-2 CPU,Unl VM); Prio 5-Yr SnS
SLES-2SUV-5YR*	SUSE Linux Entp Svr (1-2 CPU,Unl VM); Prio SnS 24x7 - 5 Year
SLES-2S-HA-1S	SUSE Linux High Availability Ext (1-2 CPU); 1yr SnS
SLES-2S-HA-1YR*	SUSE Linux High Avail Ext (1-2 CPU); Inherited SnS - 1 Year
SLES-2S-HA-3S	SUSE Linux High Availability Ext (1-2 CPU); 3yr SnS
SLES-2S-HA-3YR*	SUSE Linux High Avail Ext (1-2 CPU); Inherited SnS - 3 Year
SLES-2S-HA-5S	SUSE Linux High Availability Ext (1-2 CPU); 5yr SnS
SLES-2S-HA-5YR*	SUSE Linux High Avail Ext (1-2 CPU); Inherited SnS - 1 Year
SLES-2S-GC-1S	SUSE Linux GEO Clustering for HA (1-2 CPU); 1yr Sns
SLES-2S-GC-1YR*	SUSE Linux Geo Clustering (1-2 CPU); Inherited SnS - 1 Year
SLES-2S-GC-3S	SUSE Linux GEO Clustering for HA (1-2 CPU); 3yr SnS
SLES-2S-GC-3YR*	SUSE Linux Geo Clustering (1-2 CPU); Inherited SnS - 3 Year
SLES-2S-GC-5S	SUSE Linux GEO Clustering for HA (1-2 CPU); 5yr SnS
SLES-2S-GC-5YR*	SUSE Linux Geo Clustering (1-2 CPU); Inherited SnS - 5 Year
SLES-2S-LP-1S	SUSE Linux Live Patching Add-on (1-2 CPU); 1yr SnS Required
SLES-2S-LP-1YR*	SUSE Linux Live Patching Add-on (1-2 CPU); Inherited SnS 1 Yr
SLES-2S-LP-3S	SUSE Linux Live Patching Add-on (1-2 CPU); 3yr SnS Required
SLES-2S-LP-3YR*	SUSE Linux Live Patching Add-on (1-2 CPU); Inherited SnS 3 Yr
StorMagic	
UCS-STORM-2TB-1S	StorMagic SvSAN Software License - 2TB - 1 Year SnS
UCS-STORM-2TB-1YR*	StorMagic SvSAN - Platinum Support - 2TB - 1 Year
UCS-STORM-2TB-3S	StorMagic SvSAN Software License - 2TB - 3 Year SnS
UCS-STORM-2TB-3YR*	StorMagic SvSAN - Platinum Support - 2TB - 3 Year
UCS-STORM-2TB-5S	StorMagic SvSAN Software License - 2TB - 5 Year SnS
UCS-STORM-2TB-5YR*	StorMagic SvSAN - Platinum Support - 2TB - 5 Year
UCS-STORM-6TB-1S	StorMagic SvSAN Software License - 6TB, 1 Node; 1Yr SnS Reqd
UCS-STORM-6TB-1YR*	StorMagic SvSAN - Platinum Support - 6TB - 1 Year
UCS-STORM-6TB-3S	StorMagic SvSAN Software License - 6TB, 1 Node; 3Yr SnS Reqd
UCS-STORM-6TB-3YR*	StorMagic SvSAN - Platinum Support - 6TB - 3 Year
UCS-STORM-6TB-5S	StorMagic SvSAN Software License - 6TB, 1 Node; 5Yr SnS Reqd
UCS-STORM-6TB-5YR*	StorMagic SvSAN - Platinum Support - 6TB - 5 Year
UCS-STORM-12TB-1S	StorMagic SvSAN Software License - 12TB, 1Node; 1Yr SnS Reqd
UCS-STORM-12TB-1Y*	StorMagic SvSAN - Platinum Support - 12TB - 1 Year
UCS-STORM-12TB-3S	StorMagic SvSAN Software License - 12TB, 1Node; 3Yr SnS Reqd
UCS-STORM-12TB-3Y*	StorMagic SvSAN - Platinum Support - 12TB - 3 Year
UCS-STORM-12TB-5S	StorMagic SvSAN Software License - 12TB, 1Node; 5Yr SnS Reqd
UCS-STORM-12TB-5Y*	StorMagic SvSAN - Platinum Support - 12TB - 5 Year
UCS-STORM-UTB-1S	StorMagic SvSAN Software License - Unlimited TB - 1 Yr SnS

Table 25 Software (for 2-CPU servers)

UCS-STORM-UTB-1YR*	StorMagic SvSAN - Platinum Support - Unlimited TB - 1 Year
UCS-STORM-UTB-3S	StorMagic SvSAN Software License - Unlimited TB - 3 Yr SnS
UCS-STORM-UTB-3YR*	StorMagic SvSAN - Platinum Support - Unlimited TB - 3 Year
UCS-STORM-UTB-5S	StorMagic SvSAN Software License - Unlimited TB - 5 Yr SnS
UCS-STORM-UTB-5YR*	StorMagic SvSAN - Platinum Support - Unlimited TB - 5 Year
UCS-STORM-2TA-1S	StorMagic SvSAN Adv SW License - 2TB, 1 Node; 1Yr SnS Reqd
UCS-STORM-2TA-1Y*	StorMagic SvSAN - Adv Platinum Support - 2TB - 1 Year
UCS-STORM-2TA-3S	StorMagic SvSAN Adv SW License - 2TB, 1 Node; 3Yr SnS Reqd
UCS-STORM-2TA-3Y*	StorMagic SvSAN - Adv Platinum Support - 2TB - 3 Year
UCS-STORM-2TA-5S	StorMagic SvSAN Adv SW License - 2TB, 1 Node; 5Yr SnS Reqd
UCS-STORM-2TA-5Y*	StorMagic SvSAN - Adv Platinum Support - 2TB - 5 Year
UCS-STORM-6TA-1S	StorMagic SvSAN Adv SW License - 6TB, 1 Node; 1Yr SnS Reqd
UCS-STORM-6TA-1Y*	StorMagic SvSAN - Adv Platinum Support - 6TB - 1 Year
UCS-STORM-6TA-3S	StorMagic SvSAN Adv SW License - 6TB, 1 Node; 3Yr SnS Reqd
UCS-STORM-6TA-3Y*	StorMagic SvSAN - Adv Platinum Support - 6TB - 3 Year
UCS-STORM-6TA-5S	StorMagic SvSAN Adv SW License - 6TB, 1 Node; 5Yr SnS Reqd
UCS-STORM-6TA-5Y*	StorMagic SvSAN - Adv Platinum Support - 6TB - 5 Year
UCS-STORM-12TA-1S	StorMagic SvSAN Adv SW License - 12TB, 1 Node; 1Yr SnS Reqd
UCS-STORM-12TA-1Y*	StorMagic SvSAN - Adv Platinum Support - 12TB - 1 Year
UCS-STORM-12TA-3S	StorMagic SvSAN Adv SW License - 12TB, 1 Node; 3Yr SnS Reqd
UCS-STORM-12TA-3Y*	StorMagic SvSAN - Adv Platinum Support - 12TB - 3 Year
UCS-STORM-12TA-5S	StorMagic SvSAN Adv SW License - 12TB, 1 Node; 5Yr SnS Reqd
UCS-STORM-12TA-5Y*	StorMagic SvSAN - Adv Platinum Support - 12TB - 5 Year
UCS-STORM-UTA-1S	StorMagic SvSAN Adv SW Lic - Unlim TB, 1Node; 1Yr SnS Reqd
UCS-STORM-UTA-1Y*	StorMagic SvSAN - Adv Platinum Support - Unlimited TB - 1 Yr
UCS-STORM-UTA-3S	StorMagic SvSAN Adv SW Lic - Unlim TB, 1Node; 3Yr SnS Reqd
UCS-STORM-UTA-3Y*	StorMagic SvSAN - Adv Platinum Support - Unlimited TB - 3 Yr
UCS-STORM-UTA-5S	StorMagic SvSAN Adv SW Lic - Unlim TB, 1Node; 5Yr SnS Reqd
UCS-STORM-UTA-5Y*	StorMagic SvSAN - Adv Platinum Support - Unlimited TB - 5 Yr

STEP 22 SELECT OPERATING SYSTEM MEDIA KIT

Select the optional operating system media listed in [Table 26](#).

Table 26 OS Media

Product ID (PID)	PID Description
MSWS-12R2-ST2S-RM	Windows Server 2012 R2 Standard (2 CPU/2 VMs) Recovery Media
MSWS-12R2-DC2S-RM	Windows Server 2012 R2 Datacen(2 CPU/Unlimited VM) Rec Media
MSWS-16-ST16C-RM	Windows Server 2016 Stan (16 Cores/2 VMs) - Recovery Media
MSWS-16-ST24C-RM	Windows Server 2016 Stan (24 Cores/2 VMs) - Recovery Media
MSWS-16-DC16C-RM	Windows Server 2016 DC (16 Cores/Unlim VMs) - Recovery Media
MSWS-16-DC24C-RM	Windows Server 2016 DC (24 Cores/Unlim VMs) - Recovery Media

STEP 23 SELECT SERVICE and SUPPORT LEVEL

A variety of service options are available, as described in this section.

Unified Computing Warranty, No Contract

If you have noncritical implementations and choose to have no service contract, the following coverage is supplied:

- Three-year parts coverage.
- Next business day (NBD) parts replacement eight hours a day, five days a week.
- 90-day software warranty on media.
- Downloads of BIOS, drivers, and firmware updates.
- UCSM updates for systems with Unified Computing System Manager. These updates include minor enhancements and bug fixes that are designed to maintain the compliance of UCSM with published specifications, release notes, and industry standards.

Smart Net Total Care (SNTC) for UCS

For support of the entire Unified Computing System, Cisco offers the Cisco Smart Net Total Care for UCS Service. This service provides expert software and hardware support to help sustain performance and high availability of the unified computing environment. Access to Cisco Technical Assistance Center (TAC) is provided around the clock, from anywhere in the world

For systems that include Unified Computing System Manager, the support service includes downloads of UCSM upgrades. The Cisco Smart Net Total Care for UCS Service includes flexible hardware replacement options, including replacement in as little as two hours. There is also access to Cisco's extensive online technical resources to help maintain optimal efficiency and uptime of the unified computing environment. For more information please refer to the following url: <http://www.cisco.com/c/en/us/services/technical/smart-net-total-care.html?stickynav=1>

You can choose a desired service listed in [Table 27](#).

Table 27 Cisco SNTC for UCS Service (PID UCSC-C240-M5SX)

Service SKU	Service Level GSP	On Site?	Description
CON-PREM-C240M5SX	C2P	Yes	SNTC 24X7X2OS
CON-UCSD8-C240M5SX	UCSD8	Yes	UC SUPP DR 24X7X2OS*
CON-C2PL-C240M5SX	C2PL	Yes	LL 24X7X2OS**
CON-OSP-C240M5SX	C4P	Yes	SNTC 24X7X4OS
CON-UCSD7-C240M5SX	UCSD7	Yes	UCS DR 24X7X4OS*
CON-C4PL-C240M5SX	C4PL	Yes	LL 24X7X4OS**
CON-USD7L-C240M5SX	USD7L	Yes	LLUCS HW DR 24X7X4OS***
CON-OSE-C240M5SX	C4S	Yes	SNTC 8X5X4OS
CON-UCSD6-C240M5SX	UCSD6	Yes	UC SUPP DR 8X5X4OS*
CON-SNCO-C240M5SX	SNCO	Yes	SNTC 8x7xNCDOS****
CON-OS-C240M5SX	CS	Yes	SNTC 8X5XNBDOS
CON-UCSD5-C240M5SX	UCSD5	Yes	UCS DR 8X5XNBDOS*
CON-S2P-C240M5SX	S2P	No	SNTC 24X7X2

Table 27 Cisco SNTC for UCS Service (PID UCSC-C240-M5SX)

Service SKU	Service Level GSP	On Site?	Description
CON-S2PL-C240M5SX	S2PL	No	LL 24X7X2**
CON-SNTP-C240M5SX	SNTP	No	SNTC 24X7X4
CON-SNTPL-C240M5SX	SNTPL	No	LL 24X7X4**
CON-SNTE-C240M5SX	SNTE	No	SNTC 8X5X4
CON-SNC-C240M5SX	SNC	No	SNTC 8x7xNCD****
CON-SNT-C240M5SX	SNT	No	SNTC 8X5XNBD
CON-SW-C240M5SX	SW	No	SNTC NO RMA

Note: For PID UCSC-C240-M5S, select Service SKU with CC240M5S suffix (Example: CON-PREM-CC240M5S)

Note: For PID UCSC-C240-M5SN, select Service SKU with C240M5SN suffix (Example: CON-PREM-C240M5SN)

*Includes Drive Retention (see below for full description)

**Includes Local Language Support (see below for full description) – Only available in China and Japan

***Includes Local Language Support and Drive Retention – Only available in China and Japan

****Available in China Only

Smart Net Total Care for Cisco UCS Onsite Troubleshooting Service

An enhanced offer over traditional Smart Net Total Care which provides onsite-troubleshooting expertise to aid in the diagnostics and isolation of hardware issue within our customers' Cisco Unified Computing System (UCS) environment. It is delivered by a Cisco Certified field engineer (FE) in collaboration with remote TAC engineer and Virtual Internet working Support Engineer (VISE). You can choose a desired service listed in [Table 28](#)

Table 28 SNTC for Cisco UCS Onsite Troubleshooting Service (PID UCSC-C240-M5SX)

Service SKU	Service Level GSP	On Site?	Description
CON-OSPT-C240M5SX	OSPT	Yes	24X7X4OS Trblshtg
CON-OSPTD-C240M5SX	OSPTD	Yes	24X7X4OS TrblshtgDR*
CON-OSPTL-C240M5SX	OSPTL	Yes	24X7X4OS TrblshtgLL**
CON-OPTLD-C240M5SX	OPTLD	Yes	24X7X4OS TrblshtgLLD***

Note: For PID UCSC-C240-M5S, select Service SKU with CC240M5S suffix (Example: CON-PREM-CC240M5S)

For PID UCSC-C240-M5SN, select Service SKU with C240M5SN suffix (Example: CON-PREM-C240M5SN)

*Includes Drive Retention (see below for full description)

**Includes Local Language Support (see below for full description) – Only available in China and Japan

***Includes Local Language Support and Drive Retention – Only available in China and Japan

Solution Support for UCS

Solution Support includes both Cisco product support and solution-level support, resolving complex issues in multivendor environments, on average, 43% more quickly than product support alone. Solution Support is a critical element in data center administration, to help rapidly resolve any issue encountered, while maintaining performance, reliability, and return on investment.

This service centralizes support across your multivendor Cisco environment for both our products and solution partner products you've deployed in your ecosystem. Whether there is an issue with a Cisco or solution partner product, just call us. Our experts are the primary point of contact and own the case from first call to resolution. For more information please refer to the following url:

<http://www.cisco.com/c/en/us/services/technical/solution-support.html?stickynav=1>

You can choose a desired service listed in *Table 29*

Table 29 Solution Support for UCS Service (PID UCSC-C240-M5SX)

Service SKU	Service Level GSP	On Site?	Description
CON-SSC2P-C240M5SX	SSC2P	Yes	SOLN SUPP 24X7X2OS
CON-SSC4P-C240M5SX	SSC4P	Yes	SOLN SUPP 24X7X4OS
CON-SSC4S-C240M5SX	SSC4S	Yes	SOLN SUPP 8X5X4OS
CON-SSCS-C240M5SX	SSCS	Yes	SOLN SUPP 8X5XNBDOS
CON-SSDR7-C240M5SX	SSDR7	Yes	SSPT DR 24X7X4OS*
CON-SSDR5-C240M5SX	SSDR5	Yes	SSPT DR 8X5XNBDOS*
CON-SSS2P-C240M5SX	SSS2P	No	SOLN SUPP 24X7X2
CON-SSSNP-C240M5SX	SSSNP	No	SOLN SUPP 24X7X4
CON-SSSNE-C240M5SX	SSSNE	No	SOLN SUPP 8X5X4
CON-SSSNC-C240M5SX	SSSNC	No	SOLN SUPP NCD**
CON-SSSNT-C240M5SX	SSSNT	No	SOLN SUPP 8X5XNBD

Note: For PID UCSC-C240-M5S, select Service SKU with CC240M5S suffix (Example: CON-PREM-CC240M5S)

For PID UCSC-C240-M5SN, select Service SKU with C240M5SN suffix (Example: CON-PREM-C240M5SN)

Includes Drive Retention (see below for description)

**Available in China only

Smart Net Total Care for UCS Hardware Only Service

For faster parts replacement than is provided with the standard Cisco Unified Computing System warranty, Cisco offers the Cisco Smart Net Total Care for UCS Hardware Only Service. You can choose from two levels of advanced onsite parts replacement coverage in as little as four hours. Smart Net Total Care for UCS Hardware Only Service provides remote access any time to Cisco

support professionals who can determine if a return materials authorization (RMA) is required. You can choose a desired service listed in [Table 30](#)

Table 30 SNTC for UCS Hardware Only Service (PID UCSC-C240-M5SX)

Service SKU	Service Level GSP	On Site?	Description
CON-UCW7-C240M5SX	UCW7	Yes	UCS HW 24X7X4OS
CON-UCWD7-C240M5SX	UCWD7	Yes	UCS HW+DR 24X7X4OS*
CON-UCW7L-C240M5SX	UCW7L	Yes	LL UCS 24X7X4OS**
CON-UWD7L-C240M5SX	UWD7L	Yes	LL UCS DR 24X7X4OS***
CON-UCW5-C240M5SX	UCW5	Yes	UCS HW 8X5XNBDOS
CON-UCWD5-C240M5SX	UCWD5	Yes	UCS HW+DR 8X5XNBDOS*

Note: For PID UCSC-C240-M5S, select Service SKU with CC240M5S suffix (Example: CON-PREM-CC240M5S)
For PID UCSC-C240-M5SN, select Service SKU with C240M5SN suffix (Example: CON-PREM-C240M5SN)
*Includes Drive Retention (see below for description)
**Includes Local Language Support (see below for full description) - Only available in China and Japan
***Includes Local Language Support and Drive Retention - Only available in China and Japan

Partner Support Service for UCS

Cisco Partner Support Service (PSS) is a Cisco Collaborative Services service offering that is designed for partners to deliver their own branded support and managed services to enterprise customers. Cisco PSS provides partners with access to Cisco's support infrastructure and assets to help them:

- Expand their service portfolios to support the most complex network environments
- Lower delivery costs
- Deliver services that increase customer loyalty

PSS options enable eligible Cisco partners to develop and consistently deliver high-value technical support that capitalizes on Cisco intellectual assets. This helps partners to realize higher margins and expand their practice.

PSS is available to all Cisco PSS partners.

The two Partner Unified Computing Support Options include:

- Partner Support Service for UCS
- Partner Support Service for UCS Hardware Only

PSS for UCS provides hardware and software support, including triage support for third party software, backed by Cisco technical resources and level three support. You can choose a desired service listed in [Table 31](#).

Table 31 PSS for UCS (PID UCSC-C240-M5SX)

Service SKU	Service Level GSP	On Site?	Description
CON-PSJ8-C240M5SX	PSJ8	Yes	UCS PSS 24X7X2 OS
CON-PSJ7-C240M5SX	PSJ7	Yes	UCS PSS 24X7X4 OS

Table 31 PSS for UCS (PID UCSC-C240-M5SX)

CON-PSJD7-C240M5SX	PSJD7	Yes	UCS PSS 24X7X4 DR*
CON-PSJ6-C240M5SX	PSJ6	Yes	UCS PSS 8X5X4 OS
CON-PSJD6-C240M5SX	PSJD6	Yes	UCS PSS 8X5X4 DR*
CON-PSJ4-C240M5SX	PSJ4	No	UCS SUPP PSS 24X7X2
CON-PSJ3-C240M5SX	PSJ3	No	UCS SUPP PSS 24X7X4
CON-PSJ2-C240M5SX	PSJ2	No	UCS SUPP PSS 8X5X4
CON-PSJ1-C240M5SX	PSJ1	No	UCS SUPP PSS 8X5XNBD

Note: For PID UCSC-C240-M5S, select Service SKU with C240M5S suffix (Example: CON-PREM-C240M5S)

For PID UCSC-C240-M5SN, select Service SKU with C240M5SN suffix (Example: CON-PREM-C240M5SN)

*Includes Drive Retention (see below for description)

PSS for UCS Hardware Only

PSS for UCS Hardware Only provides customers with replacement parts in as little as two hours and provides remote access any time to Partner Support professionals who can determine if a return materials authorization (RMA) is required. You can choose a desired service listed in

[Table 32](#)

Table 32 PSS for UCS Hardware Only (PID UCSC-C240-M5SX)

Service SKU	Service Level GSP	On Site?	Description
CON-PSW7-C240M5SX	PSW7	Yes	UCS W PSS 24X7X4 OS
CON-PSWD7-C240M5SX	PSWD7	Yes	UCS W PSS 24X7X4 DR*
CON-PSW6-C240M5SX	PSW6	Yes	UCS W PSS 8X5X4 OS
CON-PSWD6-C240M5SX	PSWD6	Yes	UCS W PSS 8X5X4 DR*
CON-PSW4-C240M5SX	PSW4	No	UCS W PL PSS 24X7X2
CON-PSW3-C240M5SX	PSW3	No	UCS W PL PSS 24X7X4
CON-PSW2-C240M5SX	PSW2	No	UCS W PL PSS 8X5X4

Note: For PID UCSC-C240-M5S, select Service SKU with CC240M5S suffix (Example: CON-PREM-CC240M5S)

For PID UCSC-C240-M5SN, select Service SKU with C240M5SN suffix (Example: CON-PREM-C240M5SN)

*Includes Drive Retention (see below for description)

Unified Computing Combined Support Service

Combined Services makes it easier to purchase and manage required services under one contract. SNTC services for UCS help increase the availability of your vital data center infrastructure and realize the most value from your unified computing investment. The more benefits you realize from the Cisco Unified Computing System (Cisco UCS), the more important the technology becomes to your business. These services allow you to:

- Optimize the uptime, performance, and efficiency of your UCS
- Protect your vital business applications by rapidly identifying and addressing issues
- Strengthen in-house expertise through knowledge transfer and mentoring
- Improve operational efficiency by allowing UCS experts to augment your internal staff resources

- Enhance business agility by diagnosing potential issues before they affect your operations, You can choose a desired service listed in [Table 33](#)

Table 33 Combined Support Service for UCS (PID UCSC-C240-M5SX)

Service SKU	Service Level GSP	On Site?	Description
CON-NCF2P-C240M5SX	NCF2P	Yes	CMB SVC 24X7X2OS
CON-NCF4P-C240M5SX	NCF4P	Yes	CMB SVC 24X7X4OS
CON-NCF4S-C240M5SX	NCF4S	Yes	CMB SVC 8X5X4OS
CON-NCFCS-C240M5SX	NCFCS	Yes	CMB SVC 8X5XNBDOS
CON-NCF2-C240M5SX	NCF2	No	CMB SVC 24X7X2
CON-NCFP-C240M5SX	NCFP	No	CMB SVC 24X7X4
CON-NCFE-C240M5SX	NCFE	No	CMB SVC 8X5X4
CON-NCFT-C240M5SX	NCFT	No	CMB SVC 8X5XNBD
CON-NCFW-C240M5SX	NCFW	No	CMB SVC SW
Note: For PID UCSC-C240-M5S, select Service SKU with CC240M5S suffix (Example: CON-PREM-CC240M5S)			
For PID UCSC-C240-M5SN, select Service SKU with C240M5SN suffix (Example: CON-PREM-C240M5SN)			

UCS Drive Retention Service

With the Cisco Unified Computing Drive Retention Service, you can obtain a new disk drive in exchange for a faulty drive without returning the faulty drive.

Sophisticated data recovery techniques have made classified, proprietary, and confidential information vulnerable, even on malfunctioning disk drives. The Drive Retention service enables you to retain your drives and ensures that the sensitive data on those drives is not compromised, which reduces the risk of any potential liabilities. This service also enables you to comply with regulatory, local, and federal requirements.

If your company has a need to control confidential, classified, sensitive, or proprietary data, you might want to consider one of the Drive Retention Services listed in the above tables (where available)



NOTE: Cisco does not offer a certified drive destruction service as part of this service.

Local Language Technical Support for UCS

Where available, and subject to an additional fee, local language support for calls on all assigned severity levels may be available for specific product(s) - see tables above.

For a complete listing of available services for Cisco Unified Computing System, see the following http://www.cisco.com/en/US/products/ps10312/serv_group_home.html

OPTIONAL STEP - ORDER RACK(s)

The optional R42612 rack is available from Cisco for the C-Series servers, including the C240 M5 SFF server. This rack is a standard 19-inch rack and can be ordered with a variety of options, as listed in [Table 34](#). Racks are shipped separately from the C240 M5 SFF server.

Table 34 Racks and Rack Options

Product ID (PID)	PID Description
RACK2-UCS	<p>Cisco R42612 expansion rack, no side panels.</p> <p>This type of rack is used for multiple-rack deployments.</p>
RACK2-UCS2	<p>Cisco R42612 static (standard) rack, with side panels.</p> <p>This type of rack is used for single-rack and end of row deployments. Side panels are needed for racks at the ends of multiple-rack deployments. For example, when configuring a row of 5 racks, order 1 standard rack plus 4 expansion racks. Apply the side panels from the standard rack to the racks at each end of the row.</p>
RACK-BLANK-001	<p>Blanking panels (qty 12), 1U, plastic, toolless.</p> <p>Recommended to ensure proper airflow. Fill all empty RU spaces in the front of the rack. Because each blanking panel PID includes 12 panels, use the following calculation: $42RU - \text{occupied RU} = \text{available RU}$. Divide available RU by 12 to determine PID order quantity.</p>
RACK-CBLMGT-001	<p>Cable mgt D rings (qty 10), metal.</p> <p>Use the D rings to bundle system cables to ensure proper airflow.</p>
RACK-CBLMGT-003	<p>Brush strip (qty 1), 1 U.</p> <p>The brush strip promotes proper airflow while allowing cables to be passed from the front to the rear of the rack.</p>
RACK-CBLMGT-011	<p>Cable mgt straps (qty 10), Velcro.</p> <p>Use the Velcro straps to bundle system cables to ensure proper airflow.</p>
RACK-FASTEN-001	<p>Mounting screws (qty 100), M6.</p> <p>The rack ships with nuts and screws, but extras may be ordered.</p>
RACK-FASTEN-002	<p>Cage nuts (qty 50), M6.</p> <p>The rack ships with nuts and screws, but extras may be ordered.</p>
RACK2-JOIN-001	<p>Rack joining kit.</p> <p>Use the kit to connect adjacent racks within a row. Order 1 unit less than the number of racks in the row.</p>
RACK2-GRND-001	Cisco R42612 grounding kit

For more information about the R42612 rack, see [RACKS, page 81](#).

OPTIONAL STEP - ORDER PDU

An optional power distribution unit (PDU) is available from Cisco for the C-Series rack servers. This PDU is available in a zero rack unit (RU) style or horizontal PDU style see Cisco RP-Series Rack and Rack PDU specification for more details at:

<http://www.cisco.com/c/dam/en/us/products/collateral/servers-unified-computing/r-series-racks/rack-pdu-specsheet.pdf>

SUPPLEMENTAL MATERIAL

CHASSIS

An internal view of the C240 M5 chassis with the top cover removed is shown in *Figure 6*.

Figure 6 C240 M5 SFF With Top Cover Off

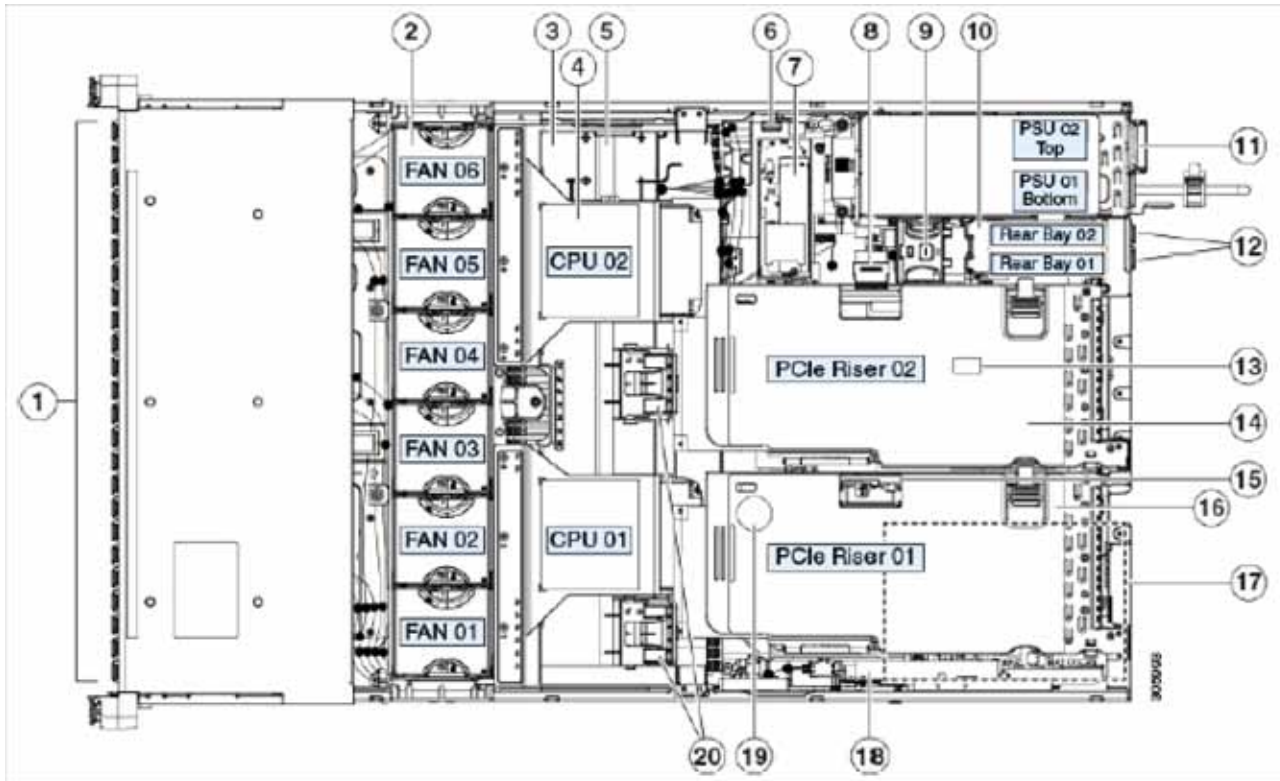

<p>1</p>	<p>Front-Facing drive bays. All drive bays support SAS/SATA HDDs/SSDs.</p> <p>NVMe PCIe SSD support:</p> <ul style="list-style-type: none"> ■ Server PID UCSC-C240-M5SN: Drive bays 1-8 support 2.5-inch NVMe PCIe SSDs. ■ All other server PIDs: Drive bays 1-2 support NVMe PCIe SSDs. 	<p>11</p> <p>Power supplies (hot-swappable, redundant as 1+1).</p>
----------	--	--

2	Fan modules (six, hot-swappable)	12	<p>Rear 2.5-inch drive bays:</p> <ul style="list-style-type: none"> ■ Server PID UCSC-C240-M5SN supports up to two NVMe PCIe SSDs (only). ■ All other C240 M5 PIDs support up to two drives: <ul style="list-style-type: none"> • When using a hardware-RAID controller card in the server, SAS/SATA HDDs or SSDs are supported. NVMe PCIe SSDs are also supported (controlled by Riser 2) • When using software RAID in the server, only NVMe PCIe SSDs are supported.
3	<p>DIMM sockets on motherboard (up to 12 per CPU; total 24). Not visible under air baffle in this view.</p>	13	Trusted platform module (TPM) socket on motherboard (not visible in this view)
4	CPUs and heatsinks (one or two). Not visible under air baffle in this view	14	<p>PCIe riser 2 (PCIe slots 4, 5, 6), with the following options:</p> <ul style="list-style-type: none"> ■ 2A—Slots 4 (x8), 5 (x16), and 6 (x16). ■ 2B—With slots 4 (x8), 5 (x16), and 6 (x8); includes one PCIe cable connector for rear NVMe SSDs. ■ 2C—With slots 4 (x8), 5 (x8), and 6 (x8); includes one PCIe cable connector for rear-facing SFF NVMe SSDs, plus one PCIe cable connector for front-facing SFF NVMe SSDs. ■ 2D - With slots 4 (x16), 5 (x8), an 6 (x8); includes one PCIe cable connector for rear SFF NVMe SSDs.
5	Supercap power module (RAID backup battery) mounting location on air baffle	15	Micro-SD card socket on PCIe riser 1
6	USB 3.0 slot on motherboard	16	<p>PCIe riser 1 (PCIe slot 1, 2, 3), with the following options:</p> <ul style="list-style-type: none"> ■ 1A—Slots 1 (x8), 2 (x16), 3 (x8); slot 2 requires CPU2. ■ 1B—Slots 1 (x8), 2 (x8), 3 (x8); all slots supported by CPU1.
7	<p>Mini-storage module connector. Supports either an SD card module with two SD card slots or an M.2 module with two PCIe NVMe/SATA M.2 SSD slots</p>	17	mLOM card socket (x16) on motherboard (not visible in this view)

8	PCIe cable connectors for NVMe SSDs, only on these PCIe riser 2 options: <ul style="list-style-type: none">■ 2B: One connector for two rear SFF NVMe SSDs■ 2C: One connector for two rear SFF NVMe SSDs plus one connector for two front-facing SFF NVMe SSDs■ 2D: One connector for two rear SFF NVMe SSDs, only available with UCSC-C240-M5SN	18	Cisco modular RAID controller PCIe slot (dedicated slot)
9	Rear-drive fan module	19	RTC battery on motherboard (not visible in this view)
10	Rear-drive backplane assembly	20	Securing clips for GPU cards on air baffle

BLOCK DIAGRAM

Figure 7 C240 M5 Block Diagram

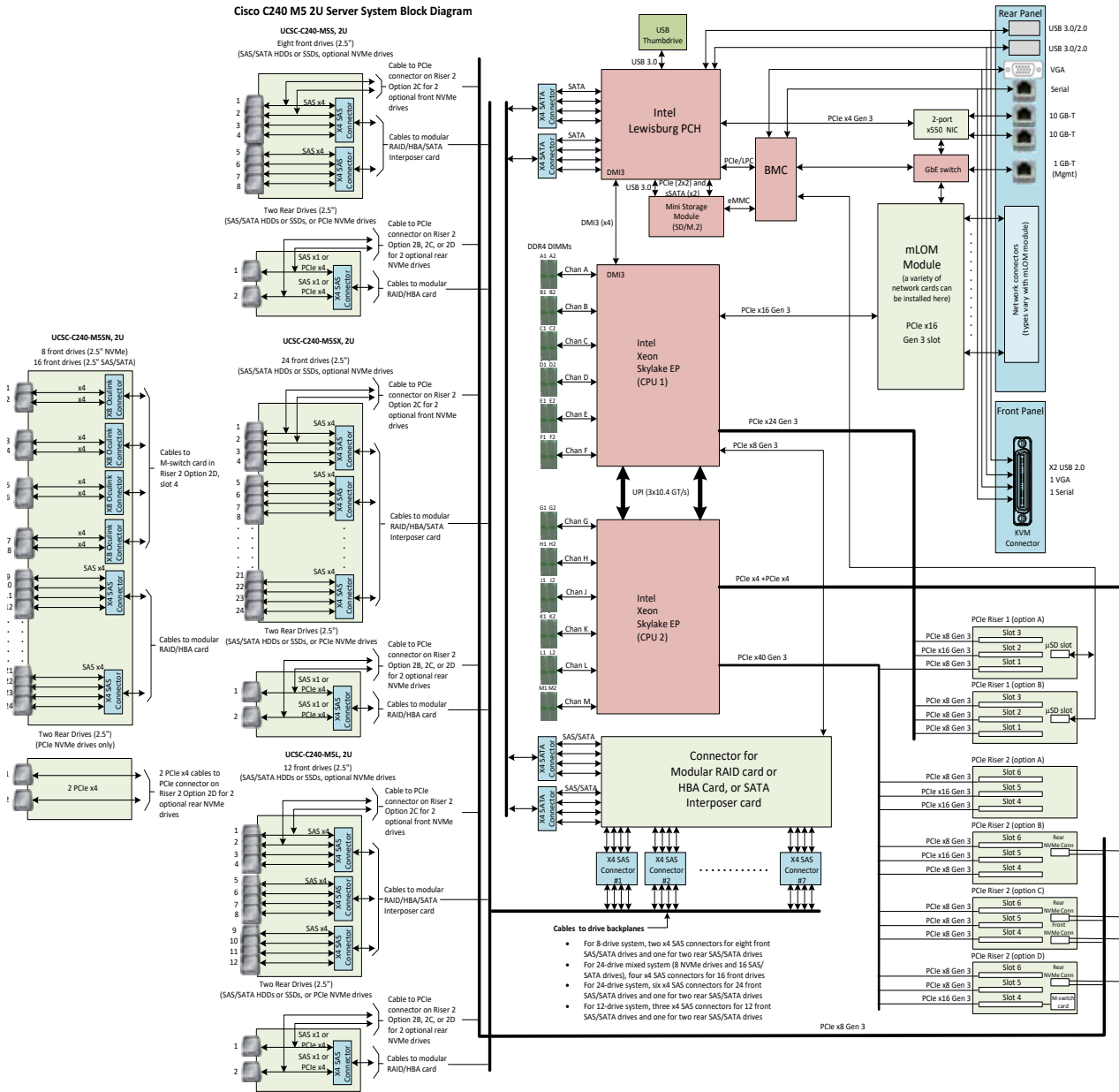

RAID Option ROM (OPROM) Settings

The server contains an Option ROM (OPROM) for the PCIe slots. The server has a finite amount of option ROM with which it can boot up devices. Go into the BIOS and disable the OPROM on the PCIe slots not used for booting so that resources are available for the slots that are used for booting. An example OPROM BIOS screen is shown in *Figure 8*.

Figure 8 Example BIOS Screen for OPROM

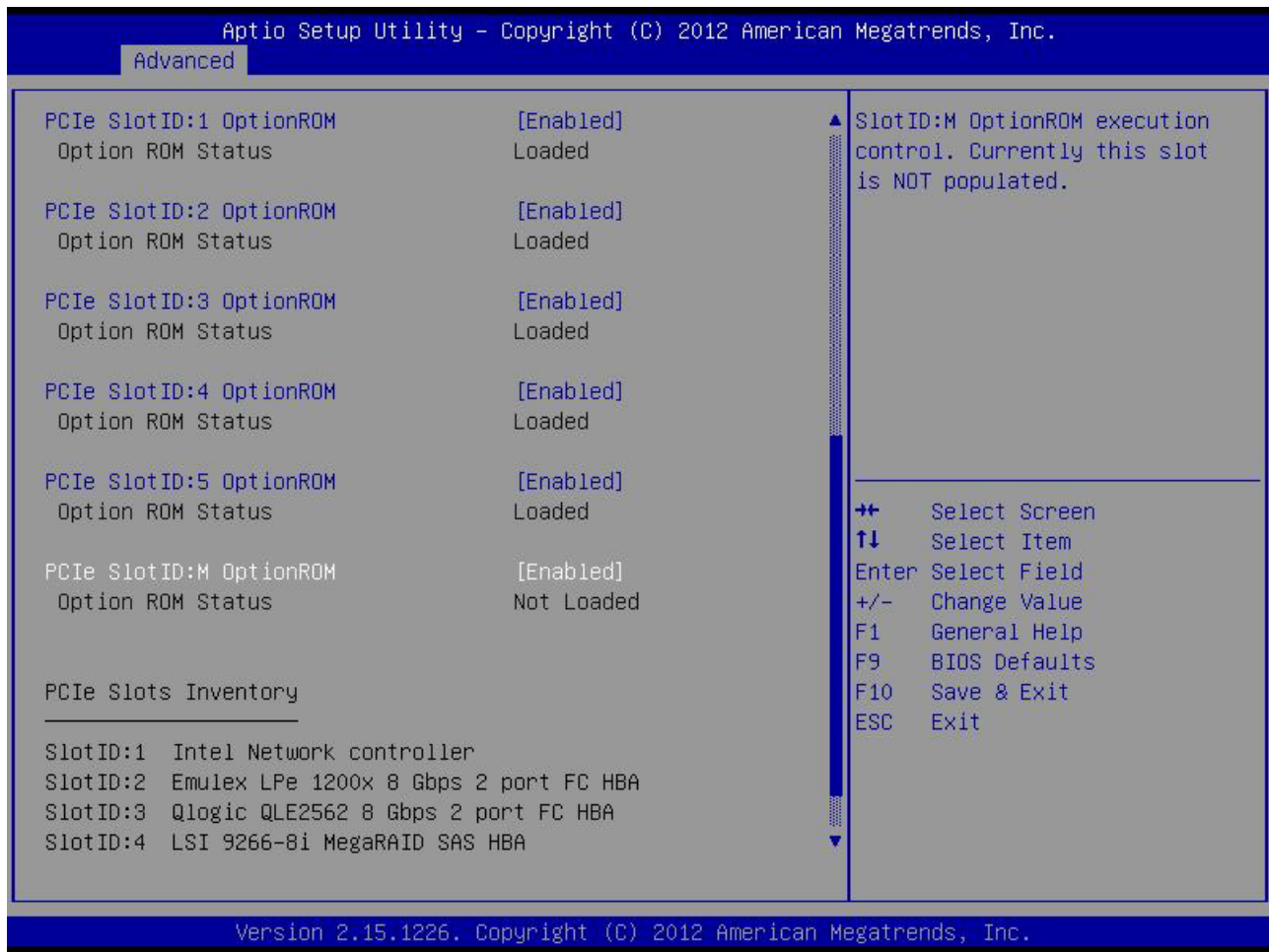

Riser Card Configuration and Options

The two riser cards are shown in *Figure 9*.

Figure 9 Riser Card 1 (slots 1, 2, and 3) and Riser Card 2 (slots 4, 5, and 6)

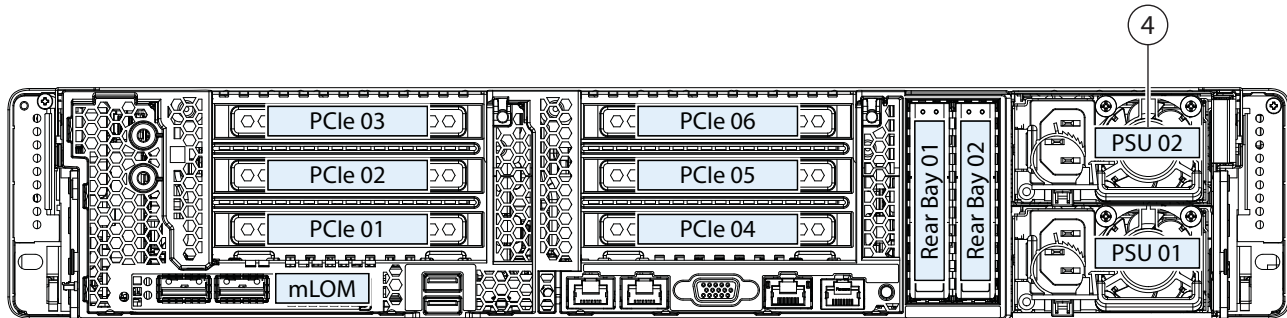

The two riser card 1 options are shown in [Table 35](#). The riser card 2 options are shown in [Table 36 on page 74](#).

Table 35 Riser Card 1 Slot Options

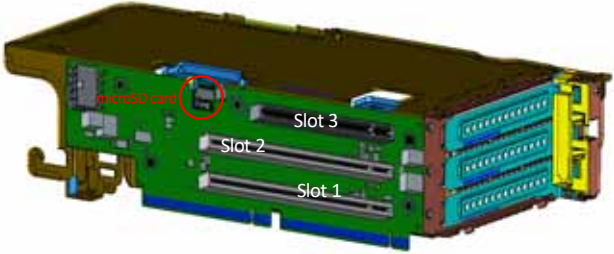
Slot #	Height	Length	Electrical	NCSI	Physical
Riser Card 1 (option 1, PID UCSC-PCI-1-C240M5)					
					
3	Full	Half	x8	No	CPU2
2	Full	Full ¹	x16	Yes ²	CPU1
1	Full	Half	x8	Yes ²	CPU1

Riser Card 1 (option 1B, PID UCSC-PCI-1B-240M5)³

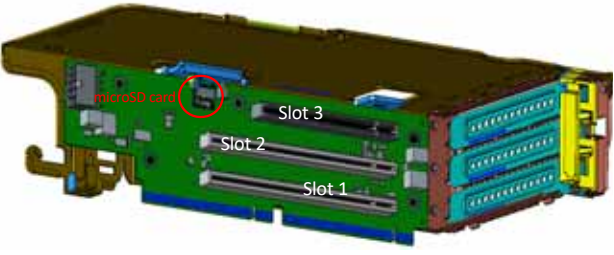
					
3	Full	Half	x8	No	CPU1
2	Full	Full	x8	Yes ²	CPU1
1	Full	Half	x8	Yes ²	CPU1

Notes:

1. GPU capable slot
2. NCSI supported in only one slot at a time (default slot 2). If a GPU card is present in slot 2, NCSI support automatically moves to slot 1.
3. No GPUs are supported on this riser. There is no GPU power connector in this version. Use riser version 1A for GPU cards.

Table 36 Riser Card 2 Slots

Slot #	Height	Length	Electrical	NCSI	Physical
--------	--------	--------	------------	------	----------

Riser Card 2 (option 2A, PID UCSC-PCI-2A-240M5)

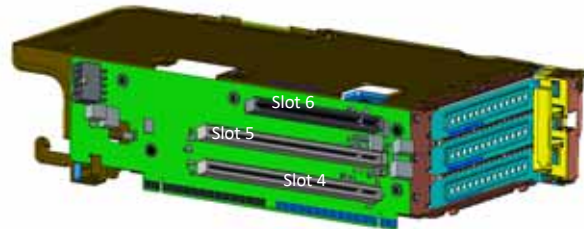

6	Full	Full	x8	No	CPU2
5	Full	Full ¹	x16	Yes ²	CPU2
4	Full	Half	x16	Yes ²	CPU2

Riser Card 2 (option 2B, PID UCSC-PCI-2B-240M5)

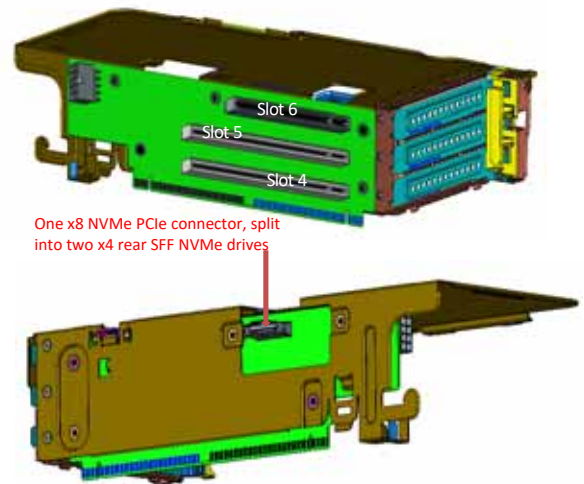

6	Full	Full	x8	No	CPU2
5	Full	Full ¹	x16	Yes ²	CPU2
4	Full	Half	x8	Yes ²	CPU2

Table 36 Riser Card 2 Slots

Slot #	Height	Length	Electrical	NCSI	Physical
--------	--------	--------	------------	------	----------

Riser Card 2 (option 2C, PID UCSC-PCI-2C-240M5)

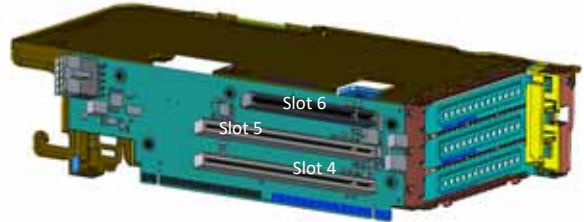

One x8 NVMe PCIe connector, split into two x4 rear SFF NVMe drives

One x8 NVMe PCIe connector, split into two x4 rear SFF NVMe drives

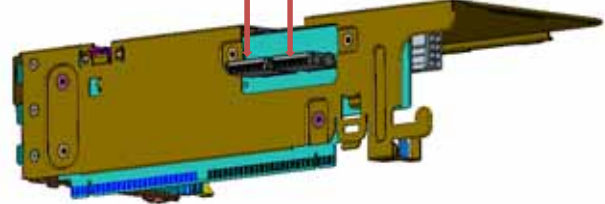

6	Full	Full	x8	No	CPU2
5	Full	Full	x8	Yes ²	CPU2
4	Full	Half	x8	Yes ²	CPU2

Riser Card 2 (option 2D, PID UCSC-PCI-2D-240M5)
Ships standard with UCSC-C240-M5SN; not supported with any other chassis version

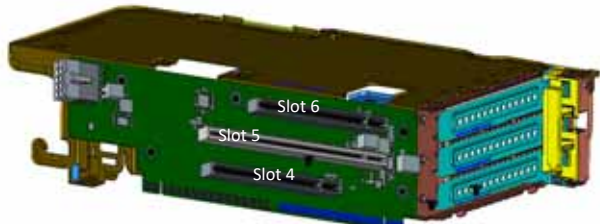

One x8 NVMe PCIe connector, split into two x4 rear SFF NVMe drives

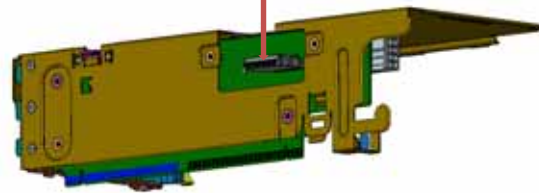

6	Full	Full	x8	No	CPU2
5	Full	Full	x8	Yes ²	CPU2
4	Full	Half	x16	Yes ²	CPU2

Notes:

1. GPU capable slot
2. NCSI supported in only one slot at a time (default slot 5). If a GPU card is present in slot 5, NCSI support automatically moves to slot 4.

To Create a RAID Group

(1) While the server is booting, wait for the prompt and press function key F2 as shown in [Figure 10](#).

Figure 10 Function Key F2 Prompt

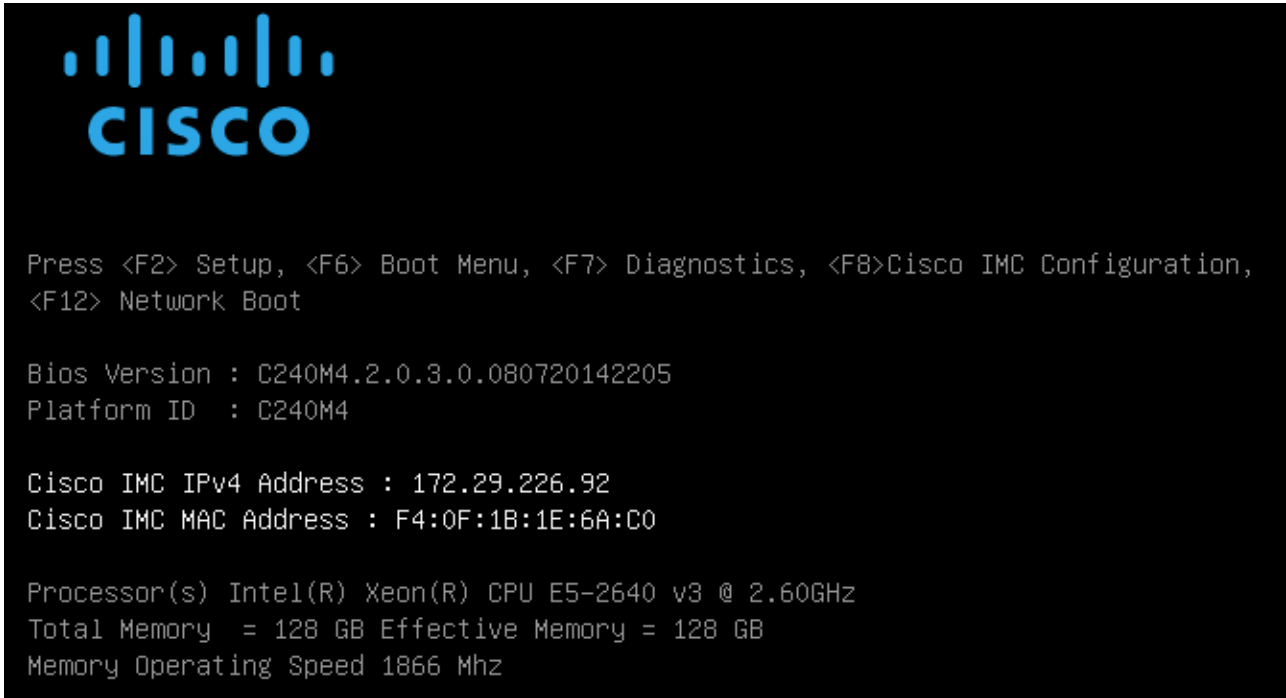

In a few seconds, you will see the screen that allows you to set up a RAID group for the primary SATA controller (see [Figure 11](#)).

Figure 11 Screen to Configure Primary SATA RAID Group

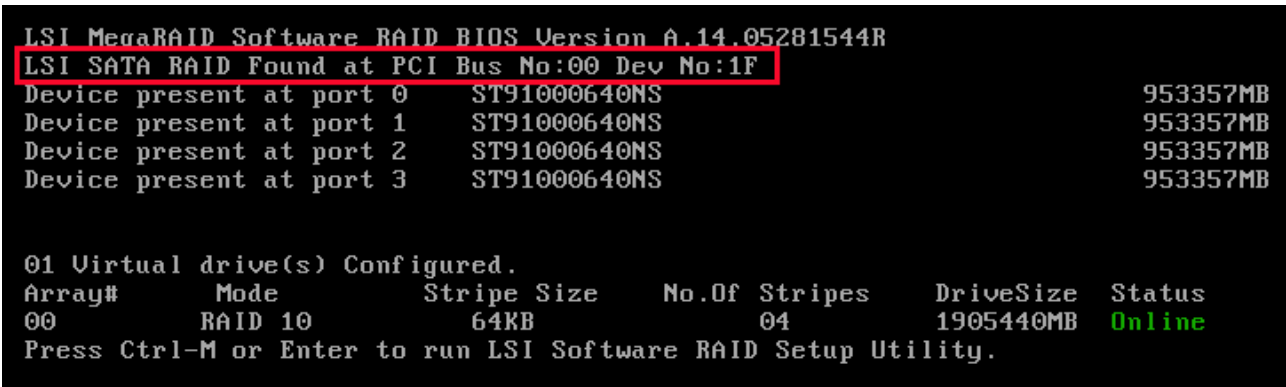

(2) Press Ctrl+M to start the RAID group creation process for the primary SATA controller (for drives 1-4, as shown in [Figure 10 on page 76](#)). Or, do nothing and wait for the next screen, which allows you to create a RAID group for the secondary SATA (sSATA) controller see [Figure 12](#).

Figure 12 Screen to Configure Secondary SATA (sSATA) RAID Group

```

Device present at port 3      ST91000640NS      953357MB

01 Virtual drive(s) Configured.
Array#      Mode      Stripe Size      No.Of Stripes      DriveSize      Status
00          RAID 10      64KB             04                 1905440MB     Online
Press Ctrl-M or Enter to run LSI Software RAID Setup Utility.

LSI MegaRAID Software RAID BIOS Version A.14.05281544R
LSI sSATA RAID Found at PCI Bus No:00 Dev No:11
Device present at port 0      INTEL SSDSC2BA200G3      190270MB
Device present at port 1      INTEL SSDSC2BA200G3      190270MB
Device present at port 2      INTEL SSDSC2BB120G4      113961MB
Device present at port 3      Micron_P400e-MTFDDAK100MAR 94884MB

04 Virtual drive(s) Configured.
Array#      Mode      Stripe Size      No.Of Stripes      DriveSize      Status
00          RAID 0      64KB             01                 189781MB     Online
01          RAID 0      64KB             01                 189781MB     Online
02          RAID 0      64KB             01                 113487MB     Online
03          RAID 0      64KB             01                 94413MB      Online
Press Ctrl-M or Enter to run LSI Software RAID Setup Utility.

```

(3) Press Ctrl+M to start the RAID group creation process for the secondary SATA (sSATA) controller (for drives 5-8, as shown in [Figure 10 on page 76](#)).

Serial Port Details

The pinout details of the rear RJ-45 serial port connector are shown in *Figure 13*.

Figure 13 Serial Port (Female RJ-45 Connector) Pinout

Serial Port (RJ-45 Female Connector)

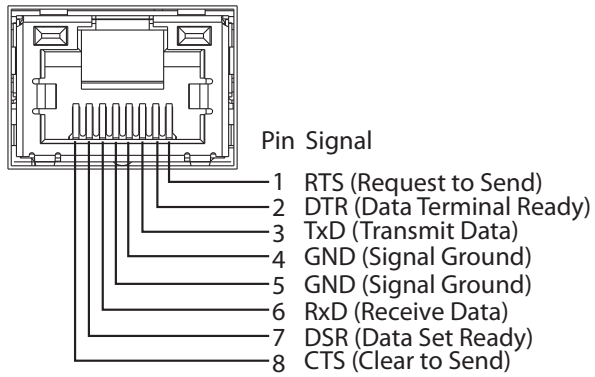

Upgrade and Servicing-Related Parts

This section lists the upgrade and servicing-related parts you may need during the life of your server. Some of these parts are configured with every server, and some may be ordered when needed or may be ordered and kept on hand as spares for future use. See [Table 37](#).

Table 37 Upgrade and Servicing-related Parts for UCS C240 M5 SFF Server

Spare Product ID (PID)	Description
UCSC-HS-C240M5=	Heat sink for UCS C240 M5 rack servers 150W CPUs & below
UCSC-HS2-C240M5=	Heat sink for UCS C240 M5 rack servers CPUs above 150W
UCS-CPUAT=	CPU Assembly Tool for M5 Servers
UCS-CPU-TIM=	CPU thermal interface material syringe for M5 server HS seal
UCSX-HSCK=	UCS Processor Heat Sink Cleaning Kit For Replacement of CPU
UCS-M5-CPU-CAR=	UCS M5 CPU Carrier
CBL-NVME-C240SFF=	C240 M5 Front NVMe cable (1) & riser 2C for SFF
UCSC-RNVME-240M5=	C240 M5 Rear NVMe cable (1) kitw/fan,riser2C,bkplnforSFF&LFF
UCSC-RSAS-C240M5=	C240 Rear UCSC-RAID-M5 SAS cbl(1)kitinclfan,bkplnforSFF&LFF
UCSC-RSAS-240M5X=	C240 Rear UCS-RAID-M5HD SAS cbl(1)kitinclfan,bkpln
UCSC-SATAIN-240M5=	C240 M5 8-drive) SATA Interposer board
UCS-AMDCBL-C240M5	C240 M5 AMD 7150x2 cable
UCS-P40CBL-C240M5	C240 M5 NVIDIA P40 cable
UCS-P100CBL-C240M5	C240 M5 NVIDIA P100 cable
UCS-M10CBL-C240M5	C240 M5 NVIDIA M10 cable
UCSC-SCAP-M5	Super Cap for UCSC-RAID-M5 and UCSC-RAID-M5HD
CBL-SC-MR12GM52=	Super Cap cable for UCSC-RAID-M5 on C240 M5 servers
CBL-SC-MR12GM5P=	Super Cap cable for UCSC-RAID-M5HD
UCSC-BBLKD-S2=	C-Series M5 SFF drive blanking panel ¹
UCSC-PCI-1-C240M5=	Riser 1 incl 3 PCIe slots (x8, x16, x8); slot 3 requires CPU2
UCSC-PCI-1B-240M5=	Riser 1B incl 3 PCIe slots (x8, x8, x8); all slots connect from CPU1
UCSC-PCI-2A-240M5=	Riser 2A incl 3 PCIe slots (x8, x16, x16) supports GPU
UCSC-PCI-2B-240M5=	Riser 2B incl 3PCieslots(x8,x16,x8); supports GPU and rear SFF NVMe
UCSC-PCI-2C-240M5=	Riser 2C incl 3 PCIe slots (3 x8) supports front and rear SFF NVMe
UCSC-PCIF-240M5=	C240 M5 PCIe Riser Blanking Panel
UCSC-PCIF-01H=	PCIe Low Profile blanking panel for UCS C-Series Server
UCSC-PCIF-01F=	PCIe Full Height blanking panel for UCS C-Series Server
UCSC-MLOMBLK-M5	C220 M5 and C240 M5 mLOM blanking panel
UCSC-CMAF-M4=	Reversible CMA for C220 M4 friction & ball bearing rail kits
UCSC-RAILB-M4=	Ball Bearing Rail Kit for C220 M4 and C240 M4 rack servers
UCSC-BZL-C240M5=	C240 M5 Security Bezel
UCSC-FAN-C240M5=	C240 M5 Fan Module (one)
UCSC-FANR-C240M5=	C240 M5 Rear Fan Module (one)

Table 37 Upgrade and Servicing-related Parts for UCS C240 M5 SFF Server

Spare Product ID (PID)	Description
N20-BKVM=	KVM cable for Server console port
UCSC-PSU-BLKP1U=	Power Supply Blanking Panel for C220 M5 and C240 M5 Servers
UCS-MSTOR-SD=	Mini Storage Carrier for SD (holds up to 2)
UCS-MSTOR-M2=	Mini Storage Carrier for M.2 SATA/NVME (holds up to 2)

Notes:

1. A drive blanking panel must be installed if you remove a disk drive from a UCS server. These panels are required to maintain system temperatures at safe operating levels, and to keep dust away from system components.

RACKS

The Cisco R42612 rack is certified for Cisco UCS installation at customer sites and is suitable for the following equipment:

- Cisco UCS B-Series servers and fabric interconnects
- Cisco UCS C-Series and select Nexus switches

The rack is compatible with hardware designed for EIA-standard 19-inch racks. see Cisco RP-Series Rack and Rack PDU specification for more details at

<http://www.cisco.com/c/dam/en/us/products/collateral/servers-unified-computing/r-series-racks/rack-pdu-specsheet.pdf>

PDU

Cisco RP Series Power Distribution Units (PDUs) offer power distribution with branch circuit protection.

Cisco RP Series PDU models distribute power to up to 42 outlets. The architecture organizes power distribution, simplifies cable management, and enables you to move, add, and change rack equipment without an electrician.

With a Cisco RP Series PDU in the rack, you can replace up to two dozen input power cords with just one. The fixed input cord connects to the power source from overhead or under-floor distribution. Your IT equipment is then powered by PDU outlets in the rack using short, easy-to-manage power cords.

The C-series servers accept the zero-rack-unit (ORU) or horizontal PDU. see Cisco RP-Series Rack and Rack PDU specification for more details at

<http://www.cisco.com/c/dam/en/us/products/collateral/servers-unified-computing/r-series-racks/rack-pdu-specsheet.pdf>

KVM CABLE

The KVM cable provides a connection into the server, providing a DB9 serial connector, a VGA connector for a monitor, and dual USB 2.0 ports for a keyboard and mouse. With this cable, you can create a direct connection to the operating system and the BIOS running on the server.

The KVM cable ordering information is listed in [Table 38](#).

Table 38 KVM Cable

Product ID (PID)	PID Description
N20-BKVM=	KVM cable for server console port

Figure 14 KVM Cable

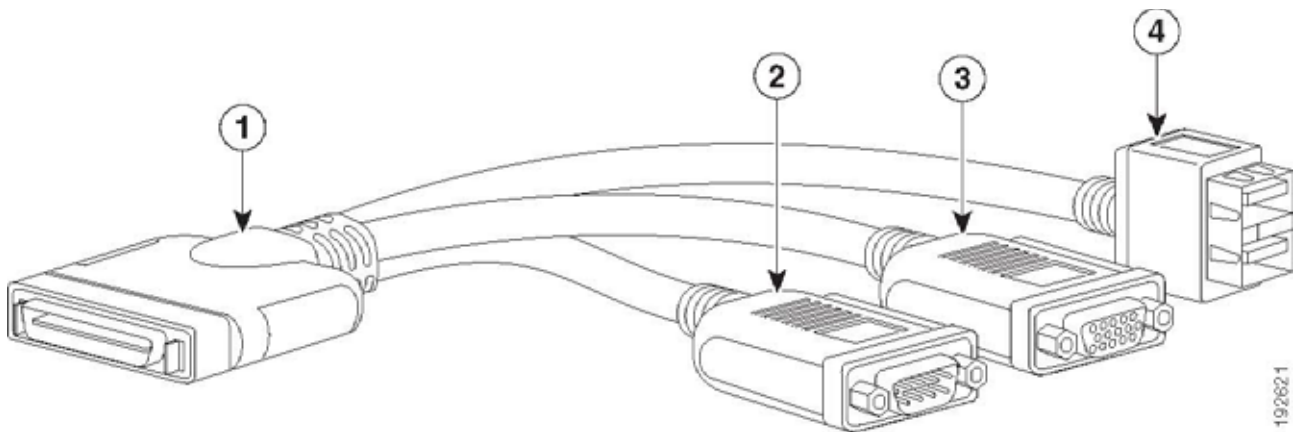

1	Connector (to server front panel)	3	VGA connector (for a monitor)
2	DB-9 serial connector	4	Two-port USB 2.0 connector (for a mouse and keyboard)

TECHNICAL SPECIFICATIONS

Dimensions and Weight

Table 39 UCS C240 M5 Dimensions and Weight

Parameter	Value
Height	3.43 in. (8.70 cm)
Width (including slam latches)	17.65 in. (44.8 cm) Including handles: 18.96 in (48.2 cm)
Depth	29.0 in. (73.8 cm) Including handles: 30.18 in (76.6 cm)
Front Clearance	3 in. (76 mm)
Side Clearance	1 in. (25 mm)
Rear Clearance	6 in. (152 mm)
Weight ¹	
Maximum	
(24 HDD model with 24 HDDs, 2 CPUs, 24 DIMMs, 2 1600 W power supplies)	57.5 lbs (26.1 kg)
(8 HDD model with 8 HDDs, 2 CPUs, 24 DIMMs, 2 1600 W power supplies)	45.5 lbs (20.4 kg)
Minimum	
(24 HDD model with 1 HDD, 1 CPU, 1 DIMM, 1 770 W power supply)	37.0 lbs (16.8 kg)
(8 HDD model with 1 HDD, 1 CPU, 1 DIMM, 1 770 W power supply)	41.5 lbs (18.8 kg)
Bare	
(24 HDD model with 0 HDD, 0 CPU, 0 DIMM, 1 770 W power supply)	35.5 lbs (16.1 kg)
(8 HDD model with 0 HDD, 0 CPU, 0 DIMM, 1 770 W power supply)	40.0 lbs (18.1 kg)

Notes:

1. Weight includes inner rail, which is attached to the server. Weight does not include outer rail, which is attached to the rack.

Power Specifications

The server is available with the following types of power supplies:

- 1050 W (AC) power supply (see [Table 40](#)).
- 1050 W V2 (DC) power supply (see [Table 41](#))
- 1600 W (AC) power supply (see [Table 42](#))

Table 40 UCS C240 M5 1050 W (AC) Power Supply Specifications

Parameter	Specification			
Input Connector	IEC320 C14			
Input Voltage Range (V rms)	100 to 240			
Maximum Allowable Input Voltage Range (V rms)	90 to 264			
Frequency Range (Hz)	50 to 60			
Maximum Allowable Frequency Range (Hz)	47 to 63			
Maximum Rated Output (W) ¹	800			1050
Maximum Rated Standby Output (W)			36	
Nominal Input Voltage (V rms)	100	120	208	230
Nominal Input Current (A rms)	9.2	7.6	5.8	5.2
Maximum Input at Nominal Input Voltage (W)	889	889	1167	1154
Maximum Input at Nominal Input Voltage (VA)	916	916	1203	1190
Minimum Rated Efficiency (%) ²	90	90	90	91
Minimum Rated Power Factor ²	0.97	0.97	0.97	0.97
Maximum Inrush Current (A peak)			15	
Maximum Inrush Current (ms)			0.2	
Minimum Ride-Through Time (ms) ³			12	

Notes:

1. Maximum rated output is limited to 800W when operating at low-line input voltage (100-127V)
2. This is the minimum rating required to achieve 80 PLUS Platinum certification, see test reports published at <http://www.80plus.org/> for certified values
3. Time output voltage remains within regulation limits at 100% load, during input voltage dropout

Table 41 UCS C240 M5 1050 W (DC) Power Supply Specifications

Parameter	Specification
Input Connector	Molex 42820
Input Voltage Range (V rms)	-48
Maximum Allowable Input Voltage Range (V rms)	-40 to -72
Frequency Range (Hz)	NA

Table 41 UCS C240 M5 1050 W (DC) Power Supply Specifications

Maximum Allowable Frequency Range (Hz)	NA
Maximum Rated Output (W)	1050
Maximum Rated Standby Output (W)	36
Nominal Input Voltage (V rms)	-48
Nominal Input Current (A rms)	24
Maximum Input at Nominal Input Voltage (W)	1154
Maximum Input at Nominal Input Voltage (VA)	1154
Minimum Rated Efficiency (%) ¹	91
Minimum Rated Power Factor ¹	NA
Maximum Inrush Current (A peak)	15
Maximum Inrush Current (ms)	0.2
Minimum Ride-Through Time (ms) ²	5

Notes:

1. This is the minimum rating required to achieve 80 PLUS Platinum certification, see test reports published at <http://www.80plus.org/> for certified values
2. Time output voltage remains within regulation limits at 100% load, during input voltage dropout

Table 42 UCS C240 M5 1600 W (AC) Power Supply Specifications

Parameter	Specification			
Input Connector	IEC320 C14			
Input Voltage Range (V rms)	200 to 240			
Maximum Allowable Input Voltage Range (V rms)	180 to 264			
Frequency Range (Hz)	50 to 60			
Maximum Allowable Frequency Range (Hz)	47 to 63			
Maximum Rated Output (W) ¹	1600			
Maximum Rated Standby Output (W)	36			
Nominal Input Voltage (V rms)	100	120	208	230
Nominal Input Current (A rms)	NA	NA	8.8	7.9
Maximum Input at Nominal Input Voltage (W)	NA	NA	1778	1758
Maximum Input at Nominal Input Voltage (VA)	NA	NA	1833	1813
Minimum Rated Efficiency (%) ²	NA	NA	90	91
Minimum Rated Power Factor ²	NA	NA	0.97	0.97
Maximum Inrush Current (A peak)	30			
Maximum Inrush Current (ms)	0.2			
Minimum Ride-Through Time (ms) ³	12			

Notes:

1. Maximum rated output is limited to 800W when operating at low-line input voltage (100-127V)
2. This is the minimum rating required to achieve 80 PLUS Platinum certification, see test reports published at <http://www.80plus.org/> for certified values
3. Time output voltage remains within regulation limits at 100% load, during input voltage dropout

For configuration-specific power specifications, use the Cisco UCS Power Calculator at this URL:

<http://ucspowercalc.cisco.com>

Environmental Specifications

The environmental specifications for the C220 M5 server are listed in [Table 43](#).

Table 43 UCS C240 M5 SFF Environmental Specifications

Parameter	Minimum
Operating Temperature	10°C to 35°C (50°F to 95°F) with no direct sunlight Maximum allowable operating temperature de-rated 1°C/300 m (1°F/547 ft) above 950 m (3117 ft)
Extended Operating Temperature	5°C to 40°C (41°F to 104°F) with no direct sunlight Maximum allowable operating temperature de-rated 1°C/175 m (1°F/319 ft) above 950 m (3117 ft) 5°C to 45°C (41°F to 113°F) with no direct sunlight Maximum allowable operating temperature de-rated 1°C/125 m (1°F/228 ft) above 950 m (3117 ft) System performance may be impacted when operating in the extended operating temperature range. Operation above 40C is limited to less than 1% of annual operating hours. Hardware configuration limits apply to extended operating temperature range.
Non-Operating Temperature	-40°C to 65°C (-40°F to 149°F) Maximum rate of change (operating and non-operating) 20°C/hr (36°F/hr)
Operating Relative Humidity	8% to 90% and 24°C (75°F) maximum dew-point temperature, non-condensing environment
Non-Operating Relative Humidity	5% to 95% and 33°C (91°F) maximum dew-point temperature, non-condensing environment
Operating Altitude	0 m to 3050 m (10,000 ft)
Non-Operating Altitude	0 m to 12,000 m (39,370 ft)
Sound Power level, Measure A-weighted per ISO7779 LWAd (Bels) Operation at 73°F (23°C)	5.8
Sound Pressure level, Measure A-weighted per ISO7779 LpAm (dBA) Operation at 73°F (23°C)	43

Extended Operating Temperature Hardware Configuration Limits

Table 44 Cisco UCS C240 M5 Extended Operating Temperature Hardware Configuration Limits

Platform ¹	ASHRAE A3 (5°C to 40°C) ²	ASHRAE A4 (5°C to 45°C) ³
Processors:	155W+	155W+ and 105W+ (4 or 6 Cores)
Memory:	LRDIMMs	LRDIMMs
Storage:	M.2 SATA SSDs	M.2 SATA SSDs
	NVMe SSDs	NVMe SSDs
		HDDs or SSDs (Rear Bays)
Peripherals:	PCIe NVMe SSDs	PCIe NVMe SSDs
	GPUs	GPUs
		VICs (Slots 1 and 4)
		NICs (Slots 1 and 4)
		HBAs (Slots 1 and 4)

Notes:

1. Two PSUs are required and PSU failure is not supported
2. Non-Cisco UCS qualified peripherals and/or peripherals that consume more than 25W are not supported
3. High power or maximum power fan control policy must be applied

Compliance Requirements

The regulatory compliance requirements for C-Series servers are listed in [Table 45](#).

Table 45 UCS C-Series Regulatory Compliance Requirements

Parameter	Description
Regulatory Compliance	Products should comply with CE Markings per directives 2014/30/EU and 2014/35/EU
Safety	UL 60950-1 Second Edition CAN/CSA-C22.2 No. 60950-1 Second Edition EN 60950-1 Second Edition IEC 60950-1 Second Edition AS/NZS 60950-1 GB4943 2001
EMC - Emissions	47CFR Part 15 (CFR 47) Class A AS/NZS CISPR32 Class A CISPR32 Class A EN55032 Class A ICES003 Class A VCCI Class A EN61000-3-2 EN61000-3-3 KN32 Class A CNS13438 Class A
EMC - Immunity	EN55024 CISPR24 EN300386 KN35



Americas Headquarters
Cisco Systems, Inc.
San Jose, CA

Asia Pacific Headquarters
Cisco Systems (USA) Pte. Ltd.
Singapore

Europe Headquarters
Cisco Systems International BV Amsterdam,
The Netherlands

Cisco has more than 200 offices worldwide. Addresses, phone numbers, and fax numbers are listed on the Cisco Website at www.cisco.com/go/offices.

Cisco and the Cisco Logo are trademarks of Cisco Systems, Inc. and/or its affiliates in the U.S. and other countries. A listing of Cisco's trademarks can be found at www.cisco.com/go/trademarks. Third party trademarks mentioned are the property of their respective owners. The use of the word partner does not imply a partnership relationship between Cisco and any other company. (1005R)